



**ARNO**<sup>®</sup>  
WERKZEUGE

**VHM- / PM-HSS WERKZEUGE:**  
Hochleistungswerkzeuge zum Fräsen und Bohren

*Solid carbide- / PM-HSS Tools:*  
*High performance tools for milling and drilling*

*Outils carbure monobloc / PM-HSS:*  
*Outils haute performance: pour le fraisage et forage*

# VOLLHARTMETALL





**ARNO – Vollhartmetall-Schaftfräser**

*Solid carbide end-mills*

Fraise à queue en carbure monobloc

Seite / Page  
**15 – 326**



**ARNO – PM-HSS-Fräser**

**Pulvermetallurgische HSS-Fräser**

*PM-HSS milling cutters /*

*Powder metallurgy and HSS milling cutters*

Fraise PM-HSS /

fraise HSS formée par métallurgie des poudres

Seite / Page  
**327 – 350**



**ARNO – VHM-Gewindefräser**

*Solid carbide thread milling cutter*

Fraise à fileter en carbure monobloc

Seite / Page  
**351 – 374**



**ARNO – VHM- und PM-HSS NC-Entgrater**

*Solid carbide and PM-HSS deburring cutters*

Ébavureur en carbure monobloc et PM-HSS NC

Seite / Page  
**375 – 384**



**ARNO – VHM- und PM-HSS-Spiralbohrer  
mit und ohne Innenkühlung**

*Solid carbide and PM-HSS*

*drills with and without internal coolant*

Foret hélicoïdal en carbure monobloc et

PM-HSS avec et sans refroidissement interne

Seite / Page  
**385 – 488**

# Übersicht ARNO-Vollhartmetallfräser

Overview solid carbide milling cutter

Aperçu ARNO fraise en carbure monobloc

**Ausführung / Design / Modèle AF** » für **Stahl- und Gusswerkstoffe** / for *steel and cast materials* / pour *les aciers courants et les fontes*

**Für die allgemeine Fräsbearbeitung von Stahl- und Gusswerkstoffen.**

*For general milling of steel and cast materials.*

*Pour le fraisage général des aciers et fonte.*

Seite / Page / Page

**29 - 72**

**Ausführung / Design / Modèle AFA** » für **Aluminium und NE-Metalle** / for *aluminium and non-ferrous materials* / pour *aluminium et métaux non ferreux*

**Höchste Performance bei der Bearbeitung von Aluminium und Nichteisenmetallen. Speziell entwickelte Geometrie mit einer höchststabilen Schneidkante garantiert beste Oberflächengüte und ausgezeichnete Spanabfuhr.**

*Best performance for aluminium and non-ferrous machining. The dedicated geometry with a very strong cutting edge guarantees best surface finish and excellent chip flow.*

*Performances supérieures lors l'usinage de l'aluminium et des matériaux non ferreux. Une géométrie spécialement conçue avec un tranchant extrêmement stable garantit une finition de surface optimale et une excellente évacuation des copeaux.*

Seite / Page / Page

**73 - 106**

**Ausführung / Design / Modèle AFD** » für **Aluminium, Graphit** / for *aluminium, graphite* / pour *aluminium, graphite*

**Durch die hohe Härte der Beschichtung ergibt sich eine ausgezeichnete Verschleißfestigkeit und sehr hohe Standzeit. Die ultrafeine Diamantbeschichtung überzeugt durch eine optimale Oberflächengüte und hohe Leistungsfähigkeit. Bei der Zerspanung von Graphit einsetzbar.**

*Due to the extreme hardness of the coating these tools offer an excellent wear resistance and very good tool life. The ultra-fine diamond coating impresses with its excellent surface finish and performance it produces. Suitable for machining graphite.*

*La dureté élevée du revêtement permet d'obtenir une excellente résistance à l'usure et une durée de vie élevée. Le revêtement DIAMANT ultra fin permet d'obtenir d'excellents états de surface et des performances élevées. Utilisable pour l'usinage du graphite.*

Seite / Page / Page

**107 - 122**

**Ausführung / Design / Modèle AFE** » für **exotische Materialien (Titan, Inconel) und rostfreie Stähle** / for *exotic materials (Titanium, Inconel) and stainless steels* / pour *des matériaux exotiques (titane, Inconel) et des aciers inoxydables*

**Ideal für die Hochgeschwindigkeitsbearbeitung von exotischen Materialien (Titan, Inconel) und rostfreien Stählen.**

*Ideal for high speed machining of exotic materials (Titanium, Inconel) and stainless steels.*

*Idéal pour un usinage à grande vitesse des matériaux exotiques (titane, Inconel) et des aciers inoxydables.*

Seite / Page / Page

**123 - 137**

**Ausführung / Design / Modèle AFG** » für **Stähle und gehärtete Stähle** / for *steel and hardened steel* / pour *aciers et aciers trempés (< 50 HRC)*

**Geeignet für die Bearbeitung legierter und unlegierter Stähle. Sehr gute Ergebnisse auch bei der Bearbeitung von gehärteten Stählen (bis 50 HRC) sowie zähen Materialien. Ausgezeichnete Ergebnisse bei der Trockenbearbeitung.**

*For machining of alloy and non-alloy steel. Excellent performance also when machining hard steel up to 50 HRC as well as tough materials. Suitable also for dry-machining.*

*Convient à l'usinage d'aciers alliés et non alliés. Très bons résultats même pour l'usinage d'aciers trempés (jusqu'à 50 HRC) ainsi que des matériaux durs. Excellents résultats d'usinage à sec.*

Seite / Page / Page

**139 - 172**

**Ausführung / Design / Modèle AFH** » für **gehärtete Stähle und HSC-Bearbeitung** / for *hardened steel and high speed milling* / pour *aciers trempés et usinage à grande vitesse (<70 HRC)*

**Zum Fräsen gehärteter Stähle bis 70 HRC. Fräsen von Gussformen im Werkzeugbau. Auch geeignet für die HSC-Bearbeitung. Trockenbearbeitung möglich.**

*For milling of hardened steel up to 70 HRC. Also suitable for high speed milling. Can be used for dry milling.*

*Pour le fraisage d'aciers trempés jusqu'à 70 HRC. Fraisage de moules pour la construction des outils.*

*Convient également à l'usinage à grande vitesse. Usinage à sec possible.*

Seite / Page / Page

**173 - 223**

**Ausführung / Design / Modèle AFJ** » für **rostfreie Stähle und exotische Materialien** / for *stainless steel and exotic materials* / pour *aciers inoxydables et matériaux exotiques*

**Spezielle Sorte zur Bearbeitung rostfreier Stähle und exotischer Materialien (z. B. Titan, Inconel oder Hastelloy).**

**Geeignet für die HSC-Bearbeitung.**

*Especially developed for machining stainless steel and exotic materials. Suitable for high speed machining.*

*Catégorie spécifique développée pour l'usinage d'aciers inoxydables et de matériaux exotiques (par ex., titane, Inconel ou Hastelloy).*

*Convient à l'usinage à grande vitesse.*

Seite / Page / Page

**225 - 236**

**Ausführung / Design / Modèle AFR** » für **Stahl, Werkzeugstahl, Gusseisen und gehärtete Werkstoffe** / for *steel, tool steel, cast iron and pre-hardened steel* / pour *acier, acier à outils, fonte et matériaux trempés (< 40 HRC)*

**Schrupfräser mit ungleicher Drallsteigung (43°–46°) für die Bearbeitung von Stahl und legierten Stählen, Werkzeugstählen, Gusseisen und gehärteten Werkstoffen bis 40 HRC.**

*Roughing cutters with unequal pitch (43°–46°) for machining steel, alloy steel, tool steel, cast materials and hardened steel up to 40 HRC.*

*Fraise d'ébauche à pas décalé (43° – 46°) pour l'usinage de l'acier et d'aciers alliés, d'aciers à outils, de fontes et de matières trempées jusqu'à 40 HRC.*

Seite / Page / Page

**237 - 246**

# Übersicht ARNO-PM-HSS Fräser

Overview PM and HSS milling cutters

Aperçu ARNO fraise PM-HSS

**Ausführung / Design / Modèle AFV » mit ungleicher Drallsteigung / with unequal pitch / avec pas inégal (35°–38°)**

VHM-Schafffräser mit ungleicher Drallsteigung (35°–38°) für höchste Ansprüche. Geeignet zum Schruppen und Schlichten fast aller Werkstoffe. Vorteile: Bis zu 60% höherer Vorschub – vibrationsfreier Lauf – bessere Oberflächengüte – größere Schnitttiefen. Solid carbide milling cutter with unequal pitch (35°–38°) for highest requirements. Suitable for roughing and finishing of nearly all materials. Advantages: up to 60% more feed rate, vibration free machining, better surface finish, increased cutting depths. Fraise à queue carbure monobloc avec pas décalé (35° – 38°) pour des exigences maximales. Convient à l'ébauche et à la finition de presque tous les matériaux. Avantages : Vitesse d'avance jusqu'à 60 % plus élevée – course sans vibrations – meilleure finition de surface – profondeurs de coupe plus importantes.

Seite / Page / Page  
**247 - 275**

**Ausführung / Design / Modèle AFX » für gehärtete Stähle bis 55 HRC, Stahl und Gusseisen / for pre-hardened steels up to 55 HRC, steel and cast iron / pour aciers trempés jusqu'à 55 HRC, acier et fonte**

VHM-Schafffräser für die Bearbeitung vorgehärteter und naturharter Werkstoffe (bis 55 HRC), Stahl und Gusseisen. Zur Hochgeschwindigkeitsbearbeitung geeignet. Auch Trockenbearbeitung ist möglich.

Solid carbide milling cutters for machining pre-hardened materials up to 55 HRC, steel materials and cast iron. Suitable for high speed milling and also for dry-machining.

Fraise à queue carbure monobloc pour l'usinage de matériaux pré-traité et à dureté naturelle (jusqu'à 55 HRC), acier et fonte. Convient à l'usinage à grande vitesse. L'usinage à sec est également possible.

Seite / Page / Page  
**277 - 325**

**Ausführung / Design / Modèle FP » für Stahl, rostfreien Stahl und Gusswerkstoffe / for steel, stainless steel and cast materials / pour acier, acier inoxydable et fonte**

Universalfräser aus pulvermetallurgischem HSS Stahl. TiAIN beschichtet, extrem zäh und verschleißfest, deutlich verbesserte Standzeiten und maximale Schnittleistung.

Universal milling cutters made from powder metal HSS steel. TiAIN coated, extremely tough and wear resistant, improved tool life and maximum cutting performance.

Fraise universelle formée par métallurgie des poudres HSS. Revêtement en TiAIN, extrêmement dur et résistant à l'usure, durée de vie considérablement améliorée et puissance de coupe maximum.

Seite / Page / Page  
**327 - 350**

## Übersicht ARNO®-VHM-Gewindefräser

Overview solid carbide thread milling cutter

Aperçu ARNO fraises à fileter carbure monobloc

**Ausführung / Design / Modèle AFT**

**Gewindefräser ISO-Innengewinde**

Thread milling cutter ISO-internal thread  
Fraise à fileter filetage intérieur ISO

Seite / Page / Page  
**351 - 363**

**Gewindefräser UNC-Innengewinde**

Thread milling cutter UNC-internal thread  
Fraise à fileter filetage intérieur UNC

Seite / Page / Page  
**364 - 366**

**Gewindefräser UNF-Innengewinde**

Thread milling cutter UNF-internal thread  
Fraise à fileter filetage intérieur UNF

Seite / Page / Page  
**367 - 368**

**Gewindefräser BSP(G)-Innengewinde**

Thread milling cutter BSP(G)-internal thread  
Fraise à fileter filetage intérieur BSP(G)

Seite / Page / Page  
**369**

**Gewindefräser NPT-Innengewinde**

Thread milling cutter NPT-internal thread  
Fraise à fileter filetage intérieur NPT

Seite / Page / Page  
**370**

# Übersicht ARNO-NC-Entgrater

Overview deburring cutter

Aperçu **ARNO** ébavureur en carbure monobloc et PM-HSS-NC

Ausführung / Design / Modèle **AE**

**TiAIN beschichtete ARNO® Vollhartmetall NC-Entgrater sind optimal geeignet zum Anfasen, Entgraten und für die Konturbearbeitung von Werkstücken nahezu aller gängigen Werkstoffe. Die Schnittgeschwindigkeit liegt bis zu 50% höher als bei unbeschichteten Werkzeugen. Auch mit MMS oder Trockenbearbeitung möglich.**

*The TiAIN coated ARNO® solid carbide NC-deburring cutter is ideal for chamfering, deburring and contour machining of nearly all conventional materials. The cutting speed is up to 50% higher compared to uncoated tools. The tools can be used with micro lubrication coolant or run dry.*

Les ébavureurs NC en carbure monobloc et à revêtement TiAIN ARNO® conviennent parfaitement au chanfreinage, à l'ébavurage et à l'usinage des contours des pièces faites à partir de presque tous les matériaux courants. La vitesse de coupe est jusqu'à 50 % plus élevée que pour les outils sans revêtement. Également possible avec micro-pulvérisation ou usinage à sec.

Seite / Page / Page

**375 - 383**

# Übersicht **ARNO**-VHM- und PM-HSS-Spiralbohrer

Overview solid carbide drills and powder metal drills

Aperçu **ARNO** foret hélicoïdal en carbure monobloc et PM-HSS

Ausführung / Design / Modèle **SP**

**ARNO® VHM-Bohrer sind durch ihre spezielle Konstruktion und höchste Genauigkeit zum Hochgeschwindigkeitsbohren und für genaue Bohrungen geeignet. Gute Leistung bei Stählen, Grauguss, Werkzeugstählen, Stahllegierungen sowie bei rost- und säurebeständigen Stählen. Schnelle Spanabfuhr und hervorragender Spanbruch durch speziell entwickelte Schneidengeometrien und Spankammern. Hohe Genauigkeit und Stabilität. Höhere Standzeiten durch TiAIN-Beschichtung. Selbstzentrierend.**

*ARNO® solid carbide drills are suitable for high speed and accurate drilling operations by special design and high quality.*

*Good performance in steels, cast iron, tool steel, alloy steels and stainless steels. Rapid chip evacuation and excellent chip breaking can be achieved by special designed cutting edges on point and chipbreakers on leading edges. High accuracy and stability.*

*Longer tool life by TiAIN coating. Self-centring.*

Grâce à leur construction spéciale et à leur précision maximale, les forets hélicoïdaux ARNO® en carbure monobloc sont adaptés aux perçages à des vitesses élevées et de précision. Bonnes performances avec les aciers, la fonte grise, les aciers à outils, les aciers alliés ainsi qu'avec les aciers inoxydables et résistants aux acides. Évacuation rapide et excellente fragmentation des copeaux grâce à des géométries de coupe et des poches à copeaux spécialement conçues. Précision et stabilités élevées. Durées de vie plus élevées grâce au revêtement en TiAIN. Autocentrant.

Seite / Page / Page

**385 - 488**

# Übersicht Fräser

Ausführung	∅	Zähne z	R	bohr- fähig	P	M	K	N	S	H [HRC]	Spiral- winkel	Beschich- tung	Seite
<b>VHM-Schaftfräser</b>													
<b>AF</b>													
AF50526 Mini	0,4 - 4,0	2		✓	●		●				30°	TiAlN	30
AF52021 Mini	0,4 - 4,0	2		✓	●		●				30°	TiAlN	32
AF60125 kurz	2,0 - 20,0	2		✓	●	●	●				30°	TiAlN	34
AF50120 -R kurz	2,0 - 12,0	2	✓	✓	●	●	●				30°	TiAlN	35
AF50121 lang	2,0	2		✓	●	●	●				30°	TiAlN	37
AF60121 lang	2,8 - 20,0	2		✓	●	●	●				30°	TiAlN	37
AF50121 -R lang	3,0 - 12,0	2	✓	✓	●	●	●				30°	TiAlN	39
AF50122 extra lang	3,0 - 20,0	2		✓	●	●	●				30°	TiAlN	40
AF60320 kurz	2,0 - 20,0	2		✓	●		●				30°	TiAlN	41
AF50321 lang	3,0 - 20,0	2		✓	●		●				30°	TiAlN	42
AF60321 lang	3,0 - 20,0	2		✓	●		●				30°	TiAlN	43
AF50322 extra lang	3,0 - 20,0	2		✓	●		●				30°	TiAlN	44
AF50135 extra kurz	0,5 - 1,8	3		✓	●	●	●				30°	TiAlN	45
AF60135 extra kurz	2,0 - 20,0	3		✓	●	●	●				30°	TiAlN	45
AF61330 kurz	2,0 - 20,0	3		✓	●	●	●				30°	TiAlN	47
AF60131 lang	3,0 - 20,0	3		✓	●	●	●				30°	TiAlN	48
AF60231 lang	3,0 - 20,0	3		✓	●	●	●				45°	TiAlN	49
AF50140 kurz	1,0 - 20,0	4		✓	●	●	●				30°	TiAlN	50
AF50140 -R kurz	2,0 - 12,0	4	✓	✓	●	●	●				30°	TiAlN	51
AF60140 kurz	2,0 - 20,0	4		✓	●	●	●				30°	TiAlN	53
AF50141 lang	2,0	4		✓	●	●	●				30°	TiAlN	54
AF60141 lang	3,0 - 20,0	4		✓	●	●	●				30°	TiAlN	54
AF50141 -R lang	3,0 - 12,0	4	✓	✓	●	●	●				30°	TiAlN	56
AF50142 extra lang	3,0 - 20,0	4		✓	●	●	●				30°	TiAlN	57
AF60142 extra lang	6,0 - 10,0	4		✓	●	●	●				30°	TiAlN	57
AF50340 kurz	2,0 - 20,0	4		✓	●		●		○		30°	TiAlN	59
AF502.0 kurz	3,0 - 20,0	4 - 6		✓	●	●	●				45°	TiAlN	60
AF50261 lang	12,0 - 20,0	6		✓	●	●	●				45°	TiAlN	61
AF614.1 lang	6,0 - 25,0	3 - 5		✓	●	●			○		30°	TiAlN	62
<b>AFA</b>													
AFA50116 mittellang	2,0 - 12,0	1		✓				●			30°	TiCN	74
AFA50220 kurz	3,0 - 20,0	2		✓				●			45°	TiCN	75
AFA51820 kurz	6,0 - 20,0	2		✓				●			50°	TiCN	76
AFA51521 lang	3,0 - 20,0	2		✓				●			45°	uncoated	77
AFA50720 -R lang	4,0 - 20,0	2	✓	✓				●			30°	TiCN	78
AFA51522 extra lang	1,0 - 20,0	2		✓				●			45°	TiCN	79
AFA50222 extra lang	1,0 - 20,0	2		✓				●			45°	TiCN	80
AFA51836 mittellang	6,0 - 20,0	3		✓				●			45°	TiCN	82
AFA52336 mittellang	3,0 - 20,0	3		✓				●			45°	TiCN	83
AFA52330 lang	3,5 - 20,0	3		✓				●			30°	uncoated	84
AFA51531 lang	3,0 - 20,0	3		✓				●			45°	TiCN	85
AFA50231 -R lang	3,0 - 20,0	3	✓	✓				●			45°	TiCN	86
AFA51532 extra lang	3,0 - 20,0	3		✓				●			45°	TiCN	87
AFA50232 extra lang	1,0 - 20,0	3		✓				●			45°	TiCN	89
AFA51831 kurz	2,0 - 20,0	3		✓				●			40°	TiCN	92
AFA61431 lang	6,0 - 25,0	3		✓				●			30°	uncoated	93
AFA51431 lang	6,0 - 25,0	3		✓				●			30°	TiCN	94
AFA52131 lang	4,0 - 20,0	3		✓				●			42°	TiCN	95
AFA51931 lang	4,0 - 20,0	3		✓				●			45°	TiCN	96
AFA52331 lang	4,0 - 20,0	3		✓				●			45°	TiCN	97
<b>AFD</b>													
AFD50724 -R Mini	0,2 - 6,0	2	✓	✓							30°	Diamant	108
AFD50121 lang	0,5 - 12,0	2		✓							30°	Diamant	110
AFD51824 Mini	0,2 - 6,0	2		✓							30°	Diamant	111
AFD54030 -R kurz	2,0 - 12,0	3	✓	✓							40°	Diamant	113

● = Hauptanwendung  
○ = Nebenanwendung

# Übersicht Fräser

Ausführung	∅	Zähne z	R	bohr- fähig	P	M	K	N	S	H [HRC]	Spiral- winkel	Beschich- tung	Seite	
<b>AFE</b>														
AFE51840 -R kurz	6,0 - 25,0	4	✓	✓	●	●	●	●	●	●	Graphit- bearbeitung	Multi	E200	124
AFE51850 kurz	6,0 - 25,0	5	✓	✓	●	●	●	●	●	●		Multi	E200	126
AFE51850 -R kurz	6,0 - 25,0	5	✓	✓	●	●	●	●	●	●		Multi	E200	127
AFE51851 lang	6,0 - 25,0	5	✓	✓	●	●	●	●	●	●		Multi	E200	128
AFE51851 -R lang	6,0 - 25,0	5	✓	✓	●	●	●	●	●	●		Multi	E200	129
AFE52451 -R lang	6,0 - 25,0	5	✓	✓	●	●	●	●	●	●		40°	E200	131
<b>AFG</b>														
AFG50120 kurz	2,0 - 25,0	2		✓	●	●					<50	30°	TiAlN	140
AFG50121 lang	2,0 - 25,0	2		✓	●	●					<50	30°	TiAlN	141
AFG50321 lang	2,0 - 25,0	2		✓	●	●					<50	30°	TiAlN	142
AFG50322	1,0 - 12,0	2			●	●					<50	30°	TiAlN	143
AFG52021 lang	0,4 - 6,0	2			●	●					<50	30°	TiAlN	144
AFG51621 lang	3,0 - 12,0	2			●	●					<50	30°	TiAlN	147
AFG50134 Mini	1,5 - 12,0	3			●	●					<50	30°	TiAlN	148
AFG60134 Mini	1,5 - 12,0	3			●	●					<50	30°	TiAlN	148
AFG50745 -R	2,0 - 16,0	4	✓		●	●					<50	30°	TiAlN	149
AFG50140 kurz	2,0 - 25,0	4			●	●					<50	30°	TiAlN	150
AFG60140 kurz	2,0 - 20,0	4			●	●					<50	30°	TiAlN	151
AFG50741 -R lang	3,0 - 20,0	4	✓		●	●					<50	30°	TiAlN	152
AFG50141 lang	2,0 - 25,0	4			●	●					<50	30°	TiAlN	154
AFG60141 lang	3,0 - 25,0	4			●	●					<50	30°	TiAlN	155
AFG502.0 lang	4,0 - 25,0	4 - 8			●	●					<50	45°	TiAlN	156
AFG602.0 lang	4,0 - 25,0	4 - 8			●	●					<50	45°	TiAlN	157
AFG50861 -R lang	6,0 - 20,0	6	✓	✓	●	●					<50	45°	TiAlN	158
AFG50262 extra lang	6,0 - 25,0	6			●	●					<50	45°	TiAlN	159
AFG60262 extra lang	6,0 - 25,0	6			●	●					<50	45°	TiAlN	160
AFG606.0 kurz	6,0 - 25,0	3 - 5			●	●					<50	20°	TiAlN	161
AFG606.1 lang	6,0 - 25,0	3 - 5			●	●					<50	20°	TiAlN	162
<b>AFH</b>														
AFH50120 -R Mini	0,3 - 2,0	2	✓	✓	●	●					●	30°	TiA70	174
AFH50526 Mini	0,1 - 4,0	2		✓	●	●					●	30°	TiA70	175
AFH50920 -R Mini	0,5 - 2,0	2	✓	✓	●	●					●	30°	TiA70	177
AFH50320 Mini	0,4 - 2,0	2		✓	●	●					●	30°	TiA70	178
AFH52020 Mini	0,5 - 2,0	2		✓	●	●					●	30°	TiA70	179
AFH52021 Mini	0,1 - 4,0	2		✓	●	●					●	30°	TiA70	180
AFH50125	0,1 - 20,0	2		✓	●	●					●	30°	TiA70	182
AFH50725 -R	0,5 - 20,0	2	✓	✓	●	●					●	30°	TiA70	184
AFH50926 -R	0,5 - 12,0	2	✓	✓	●	●					●	30°	TiA70	186
AFH51625	1,0 - 25,0	2		✓	●	●					●	30°	TiA70	189
AFH51626	0,1 - 12,0	2		✓	●	●					●	30°	TiA70	191
AFH51635	3,0 - 20,0	3		✓	●	●					●	30°	TiA70	193
AFH50140	1,0 - 20,0	4			●	●					●	30°	TiA70	194
AFH50142 -R	6,0 - 12,0	4	✓		●	●					●	30°	TiA70	195
AFH50146 -R	3,0 - 12,0	4	✓		●	●					●	30°	TiA70	196
AFH50745 -R	1,0 - 20,0	4	✓		●	●					●	30°	TiA70	198
AFH50341	3,0 - 20,0	4		✓	●	●					●	30°	TiA70	200
AFH50865 -R	6,0 - 20,0	6	✓		●	●					●	45°	TiA70	201
AFH508.1 lang	6,0 - 25,0	6 - 8		✓	●	●					●	45°	TiA70	202
AFH508.2 extra lang	6,0 - 25,0	6 - 8		✓	●	●					●	45°	TiA70	203
AFH50746 -R kurz	2,0 - 12,0	4	✓		●	●					●	90°	TiA70	204
AFH50741 -R lang	2,0 - 16,0	4	✓		●	●					●	90°	TiA70	205
<b>AFJ</b>														
AFJ612.1 lang	3,0 - 25,0	3 - 4		✓	○	●						50°	TiAlN	226
AFJ602.0 lang	3,0 - 20,0	4 - 8			○	●						45°	TiAlN	227
AFJ619.1 lang	4,0 - 25,0	3 - 6			○	●						45°	TiAlN	228

● = Hauptanwendung  
○ = Nebenanwendung

Alle Angaben in mm

# Übersicht Fräser

Ausführung	∅	Zähne z	R	bohr- fähig	P	M	K	N	S	H [HRC]	Spiral- winkel	Beschich- tung	Seite
<b>AFR</b>													
AFR619.0 kurz	6,0 - 20,0	4 - 5	✓	✓	●	●	●			<40	43 - 46°	AlCrN	238
AFR619.1 extra lang	6,0 - 20,0	4 - 5	✓	✓	●	●	●			<40	43 - 46°	AlCrN	239
AFR619.2 lang	6,0 - 20,0	4 - 5	✓	✓	●	●	●			<40	43 - 46°	AlCrN	240
AFR619.3 lang	6,0 - 20,0	4 - 5			●	●	●			<40	43 - 46°	TiAlN	241
<b>AFV</b>													
AFV61840 -R kurz	3,0 - 20,0	4			○	●	○		○		35 - 38°	TiAlN	248
AFV61840 kurz	3,0 - 20,0	4		✓	●	●	●		●		Multi	S100	249
AFV61840 -R kurz	3,0 - 20,0	4	✓	✓	●	●	●		●		Multi	S100	250
AFV61840 -R kurz	3,0 - 20,0	4	✓		○	●	○		○		35 - 38°	TiAlN	251
AFV62342 kurz	3,0 - 20,0	4			●	●	●		●		35 - 38°	S100	252
AFV62342 -R kurz	3,0 - 20,0	4	✓		●	●	●		●		35 - 38°	S100	254
AFV61841 -R lang	3,0 - 25,0	4		✓	●	●	●		●		Multi	S100	256
AFV61841 lang	3,0 - 25,0	4			○	●	○		○		35 - 38°	TiAlN	257
AFV61841 -R lang	3,0 - 25,0	4	✓	✓	●	●	●		●		Multi	S100	258
AFV61841 -R lang	3,0 - 25,0	4	✓		○	●	○		○		35 - 38°	TiAlN	259
AFV60341 lang	3,0 - 25,0	4			○	●	○		○		35 - 38°	TiAlN	260
AFV61646 lang	3,0 - 25,0	4			●	●	●		●		Multi	S100	261
AFV61851 lang	6,0 - 25,0	5			○	●	○		○		35 - 38°	TiAlN	262
AFV60266 lang	3,0 - 25,0	6			●	●	●		●		45°	S100	263
AFV60266 extra lang	6,0 - 25,0	6	✓		●	●	●		●		45°	S100	264
AFV60861 -R lang	6,0 - 25,0	6	✓	✓	●	●	●		●		45°	S100	265
AFV60862 -R extra lang	6,0 - 25,0	6	✓	✓	●	●	●		●		45°	S100	266
<b>AFX</b>													
AFX50124 -R Mini	0,2 - 20,0	2	✓		●		●			●	30°	S100	278
AFX50120 kurz	0,1 - 20,0	2			●					●	30°	S100	282
AFX50121 lang	1,0 - 20,0	2			●		●			●	30°	S100	284
AFX50121 -R lang	1,0 - 20,0	2	✓		●		●			●	30°	S100	286
AFX50122 extra lang	0,2 - 12,0	2			●		●			●	30°	S100	288
AFX50321 lang	0,1 - 20,0	2			●		●			●	30°	S100	291
AFX52021 lang	0,2 - 12,0	2			●		●			●	30°	S100	294
AFX50140 kurz	1,0 - 25,0	4		✓	●		●			●	26 - 30°	S100	297
AFX50041 -R lang	1,0 - 20,0	4	✓	✓	●		●			●	30 - 38°	S100	299
AFX50741 -R lang	1,0 - 20,0	4	✓	✓	●		●			●	30°	S100	302
AFX50042 extra lang	1,0 - 20,0	4		✓	●		●			●	35 - 38°	S100	304
AFX50141 lang	1,0 - 25,0	4		✓	●		●			●	30°	S100	305
AFX50142 extra lang	1,0 - 12,0	4		✓	●		●			●	30°	S100	307
AFX50260 kurz	6,0 - 20,0	6		✓	●		●			●	45°	S100	309
<b>PM-HSS-Schaftfräser</b>													
<b>FP</b>													
FP60120 kurz	2,0 - 25,0	2		✓	●	●	●		○	<40	30°	TiAlN	332
FP60121 lang	2,0 - 25,0	2		✓	●	●	●		○	<40	30°	TiAlN	333
FP60320 kurz	2,0 - 25,0	2		✓	●	●	●		○	<40	30°	TiAlN	334
FP60135 extra kurz	3,0 - 25,0	2		✓	●	●	●		○	<40	30°	TiAlN	335
FP60130 kurz	2,0 - 25,0	3		✓	●	●	●		○	<40	30°	TiAlN	336
FP601.0 kurz	2,0 - 25,0	3		✓	●	●	●		○	<40	30°	TiAlN	337
FP601.1 lang	2,0 - 32,0	4 - 6		✓	●	●	●		○	<40	30°	TiAlN	338
FP618.0 kurz	2,0 - 32,0	4 - 6		✓	●	●	●		○	<40	30°	TiAlN	339
FP618.6 mittellang	6,0 - 32,0	3 - 6		< ∅ 20	●	●	●		○	<40	30°	TiAlN	340
FP618.1 lang	6,0 - 32,0	3 - 6		< ∅ 20	●	●	●		○	<40	30°	TiAlN	341
FP619.5 extra kurz	6,0 - 25,0	3 - 6		< ∅ 20	●	●	●		○	<40	30°	TiAlN	342
FP619.0 kurz	4,0 - 25,0	4 - 6		< ∅ 20	●	●	●		○	<40	45°	TiAlN	343
FP620.0 kurz	6,0 - 32,0	3 - 6		< ∅ 20	●	●	●		○	<40	45°	TiAlN	344
FP623.1 extra lang	6,0 - 32,0	3 - 6		< ∅ 20	●	●	●		○	<40	30°	TiAlN	345

● = Hauptanwendung  
○ = Nebenanwendung



# Overview Milling

Version	∅	Teeth z	R	Center cutting	P	M	K	N	S	H [HRC]	Helix- angle	Coating	Page
<b>Solid carbide milling cutters</b>													
<b>AF</b>													
AF50526 Mini	0,4 - 4,0	2		✓	●		●				30°	TiAlN	30
AF52021 Mini	0,4 - 4,0	2		✓	●		●				30°	TiAlN	32
AF60125 short	2,0 - 20,0	2		✓	●	●	●				30°	TiAlN	34
AF50120 -R short	2,0 - 12,0	2	✓	✓	●	●	●				30°	TiAlN	35
AF50121 long	2,0	2		✓	●	●	●				30°	TiAlN	37
AF60121 long	2,8 - 20,0	2		✓	●	●	●				30°	TiAlN	37
AF50121 -R long	3,0 - 12,0	2	✓	✓	●	●	●				30°	TiAlN	39
AF50122 extra long	3,0 - 20,0	2		✓	●	●	●				30°	TiAlN	40
AF60320 short	2,0 - 20,0	2		✓	●		●				30°	TiAlN	41
AF50321 long	3,0 - 20,0	2		✓	●		●				30°	TiAlN	42
AF60321 long	3,0 - 20,0	2		✓	●		●				30°	TiAlN	43
AF50322 extra long	3,0 - 20,0	2		✓	●		●				30°	TiAlN	44
AF50135 extra short	0,5 - 1,8	3		✓	●	●	●				30°	TiAlN	45
AF60135 extra short	2,0 - 20,0	3		✓	●	●	●				30°	TiAlN	45
AF61330 short	2,0 - 20,0	3		✓	●	●	●				30°	TiAlN	47
AF60131 long	3,0 - 20,0	3		✓	●	●	●				30°	TiAlN	48
AF60231 long	3,0 - 20,0	3		✓	●	●	●				45°	TiAlN	49
AF50140 short	1,0 - 20,0	4		✓	●	●	●				30°	TiAlN	50
AF50140 -R short	2,0 - 12,0	4	✓	✓	●	●	●				30°	TiAlN	51
AF60140 short	2,0 - 20,0	4		✓	●	●	●				30°	TiAlN	53
AF50141 long	2,0	4		✓	●	●	●				30°	TiAlN	54
AF60141 long	3,0 - 20,0	4		✓	●	●	●				30°	TiAlN	54
AF50141 -R long	3,0 - 12,0	4	✓	✓	●	●	●				30°	TiAlN	56
AF50142 extra long	3,0 - 20,0	4		✓	●	●	●				30°	TiAlN	57
AF60142 extra long	6,0 - 10,0	4		✓	●	●	●				30°	TiAlN	57
AF50340 short	2,0 - 20,0	4		✓	●		●		○		30°	TiAlN	59
AF502.0 short	3,0 - 20,0	4 - 6		✓	●	●	●				45°	TiAlN	60
AF50261 long	12,0 - 20,0	6		✓	●	●	●				45°	TiAlN	61
AF614.1 long	6,0 - 25,0	3 - 5		✓	●	●			○		30°	TiAlN	62
<b>AFA</b>													
AFA50116 mid-length	2,0 - 12,0	1		✓				●			30°	TiCN	74
AFA50220 short	3,0 - 20,0	2		✓				●			45°	TiCN	75
AFA51820 short	6,0 - 20,0	2		✓				●			50°	TiCN	76
AFA51521 long	3,0 - 20,0	2		✓				●			45°	uncoated	77
AFA50720 -R long	4,0 - 20,0	2	✓	✓				●			30°	TiCN	78
AFA51522 extra long	1,0 - 20,0	2		✓				●			45°	TiCN	79
AFA50222 extra long	1,0 - 20,0	2		✓				●			45°	TiCN	80
AFA51836 mid-length	6,0 - 20,0	3		✓				●			45°	TiCN	82
AFA52336 mid-length	3,0 - 20,0	3		✓				●			45°	TiCN	83
AFA52330 long	3,5 - 20,0	3		✓				●			30°	uncoated	84
AFA51531 long	3,0 - 20,0	3		✓				●			45°	TiCN	85
AFA50231 -R long	3,0 - 20,0	3	✓	✓				●			45°	TiCN	86
AFA51532 extra long	3,0 - 20,0	3		✓				●			45°	TiCN	87
AFA50232 extra long	1,0 - 20,0	3		✓				●			45°	TiCN	89
AFA51831 short	2,0 - 20,0	3		✓				●			40°	TiCN	92
AFA61431 long	6,0 - 25,0	3		✓				●			30°	uncoated	93
AFA51431 long	6,0 - 25,0	3		✓				●			30°	TiCN	94
AFA52131 long	4,0 - 20,0	3		✓				●			42°	TiCN	95
AFA51931 long	4,0 - 20,0	3		✓				●			45°	TiCN	96
AFA52331 long	4,0 - 20,0	3		✓				●			45°	TiCN	97
<b>AFD</b>													
AFD50724 -R Mini	0,2 - 6,0	2	✓	✓							30°	Diamant	108
AFD50121 long	0,5 - 12,0	2		✓							30°	Diamant	110
AFD51824 Mini	0,2 - 6,0	2		✓							30°	Diamant	111
AFD54030 -R short	2,0 - 12,0	3	✓	✓							40°	Diamant	113

● = Main application  
○ = Suitable

Dimensions in mm

# Overview Milling

Version	∅	Teeth z	R	Center cutting	P	M	K	N	S	H [HRC]	Helix- angle	Coating	Page
<b>AFE</b>													
AFE51840 -R short	6,0 - 25,0	4	✓	✓	●	●	●	●	●	Graphite machining	Multi	E200	124
AFE51850 short	6,0 - 25,0	5	✓	✓	●	●	●	●	●		Multi	E200	126
AFE51850 -R short	6,0 - 25,0	5	✓	✓	●	●	●	●	●		Multi	E200	127
AFE51851 long	6,0 - 25,0	5	✓	✓	●	●	●	●	●		Multi	E200	128
AFE51851 -R long	6,0 - 25,0	5	✓	✓	●	●	●	●	●		Multi	E200	129
AFE52451 -R long	6,0 - 25,0	5	✓	✓	●	●	●	●	●		40°	E200	131
<b>AFG</b>													
AFG50120 short	2,0 - 25,0	2		✓	●	●	●	●	●	<50	30°	TiAlN	140
AFG50121 long	2,0 - 25,0	2		✓	●	●	●	●	●	<50	30°	TiAlN	141
AFG50321 long	2,0 - 25,0	2		✓	●	●	●	●	●	<50	30°	TiAlN	142
AFG50322	1,0 - 12,0	2			●	●	●	●	●	<50	30°	TiAlN	143
AFG52021 long	0,4 - 6,0	2			●	●	●	●	●	<50	30°	TiAlN	144
AFG51621 long	3,0 - 12,0	2			●	●	●	●	●	<50	30°	TiAlN	147
AFG50134 Mini	1,5 - 12,0	3			●	●	●	●	●	<50	30°	TiAlN	148
AFG60134 Mini	1,5 - 12,0	3			●	●	●	●	●	<50	30°	TiAlN	148
AFG50745 -R	2,0 - 16,0	4	✓		●	●	●	●	●	<50	30°	TiAlN	149
AFG50140 short	2,0 - 25,0	4			●	●	●	●	●	<50	30°	TiAlN	150
AFG60140 short	2,0 - 20,0	4			●	●	●	●	●	<50	30°	TiAlN	151
AFG50741 -R long	3,0 - 20,0	4	✓		●	●	●	●	●	<50	30°	TiAlN	152
AFG50141 long	2,0 - 25,0	4			●	●	●	●	●	<50	30°	TiAlN	154
AFG60141 long	3,0 - 25,0	4			●	●	●	●	●	<50	30°	TiAlN	155
AFG502.0 long	4,0 - 25,0	4 - 8			●	●	●	●	●	<50	45°	TiAlN	156
AFG602.0 long	4,0 - 25,0	4 - 8			●	●	●	●	●	<50	45°	TiAlN	157
AFG50861 -R long	6,0 - 20,0	6	✓	✓	●	●	●	●	●	<50	45°	TiAlN	158
AFG50262 extra long	6,0 - 25,0	6			●	●	●	●	●	<50	45°	TiAlN	159
AFG60262 extra long	6,0 - 25,0	6			●	●	●	●	●	<50	45°	TiAlN	160
AFG606.0 short	6,0 - 25,0	3 - 5			●	●	●	●	●	<50	20°	TiAlN	161
AFG606.1 long	6,0 - 25,0	3 - 5			●	●	●	●	●	<50	20°	TiAlN	162
<b>AFH</b>													
AFH50120 -R Mini	0,3 - 2,0	2	✓	✓	●	●	●	●	●	●	30°	TiA70	174
AFH50526 Mini	0,1 - 4,0	2		✓	●	●	●	●	●	●	30°	TiA70	175
AFH50920 -R Mini	0,5 - 2,0	2	✓	✓	●	●	●	●	●	●	30°	TiA70	177
AFH50320 Mini	0,4 - 2,0	2		✓	●	●	●	●	●	●	30°	TiA70	178
AFH52020 Mini	0,5 - 2,0	2		✓	●	●	●	●	●	●	30°	TiA70	179
AFH52021 Mini	0,1 - 4,0	2		✓	●	●	●	●	●	●	30°	TiA70	180
AFH50125	0,1 - 20,0	2		✓	●	●	●	●	●	●	30°	TiA70	182
AFH50725 -R	0,5 - 20,0	2	✓	✓	●	●	●	●	●	●	30°	TiA70	184
AFH50926 -R	0,5 - 12,0	2	✓	✓	●	●	●	●	●	●	30°	TiA70	186
AFH51625	1,0 - 25,0	2		✓	●	●	●	●	●	●	30°	TiA70	189
AFH51626	0,1 - 12,0	2		✓	●	●	●	●	●	●	30°	TiA70	191
AFH51635	3,0 - 20,0	3		✓	●	●	●	●	●	●	30°	TiA70	193
AFH50140	1,0 - 20,0	4			●	●	●	●	●	●	30°	TiA70	194
AFH50142 -R	6,0 - 12,0	4	✓		●	●	●	●	●	●	30°	TiA70	195
AFH50146 -R	3,0 - 12,0	4	✓		●	●	●	●	●	●	30°	TiA70	196
AFH50745 -R	1,0 - 20,0	4	✓		●	●	●	●	●	●	30°	TiA70	198
AFH50341	3,0 - 20,0	4		✓	●	●	●	●	●	●	30°	TiA70	200
AFH50865 -R	6,0 - 20,0	6	✓		●	●	●	●	●	●	45°	TiA70	201
AFH508.1 long	6,0 - 25,0	6 - 8		✓	●	●	●	●	●	●	45°	TiA70	202
AFH508.2 extra long	6,0 - 25,0	6 - 8		✓	●	●	●	●	●	●	45°	TiA70	203
AFH50746 -R short	2,0 - 12,0	4	✓		●	●	●	●	●	●	90°	TiA70	204
AFH50741 -R long	2,0 - 16,0	4	✓		●	●	●	●	●	●	90°	TiA70	205
<b>AFJ</b>													
AFJ612.1 long	3,0 - 25,0	3 - 4		✓	○	●	●	●	●	●	50°	TiAlN	226
AFJ602.0 long	3,0 - 20,0	4 - 8			○	●	●	●	●	●	45°	TiAlN	227
AFJ619.1 long	4,0 - 25,0	3 - 6			○	●	●	●	●	●	45°	TiAlN	228

● = Main application  
○ = Suitable

Dimensions in mm

# Overview Milling

Version	∅	Teeth z	R	Center cutting	P	M	K	N	S	H [HRC]	Helix- angle	Coating	Page
<b>AFR</b>													
AFR619.0 short	6,0 - 20,0	4 - 5	✓	✓	●	●	●			<40	43 - 46°	AlCrN	238
AFR619.1 extra long	6,0 - 20,0	4 - 5	✓	✓	●	●	●			<40	43 - 46°	AlCrN	239
AFR619.2 long	6,0 - 20,0	4 - 5	✓	✓	●	●	●			<40	43 - 46°	AlCrN	240
AFR619.3 long	6,0 - 20,0	4 - 5			●	●	●			<40	43 - 46°	TiAlN	241
<b>AFV</b>													
AFV61840 -R short	3,0 - 20,0	4			○	●	○		○		35 - 38°	TiAlN	248
AFV61840 short	3,0 - 20,0	4		✓	●	●	●		●		Multi	S100	249
AFV61840 -R short	3,0 - 20,0	4	✓	✓	●	●	●		●		Multi	S100	250
AFV61840 -R short	3,0 - 20,0	4	✓		○	●	○		○		35 - 38°	TiAlN	251
AFV62342 short	3,0 - 20,0	4			●	●	●		●		35 - 38°	S100	252
AFV62342 -R short	3,0 - 20,0	4	✓		●	●	●		●		35 - 38°	S100	254
AFV61841 -R long	3,0 - 25,0	4		✓	●	●	●		●		Multi	S100	256
AFV61841 long	3,0 - 25,0	4			○	●	○		○		35 - 38°	TiAlN	257
AFV61841 -R long	3,0 - 25,0	4	✓	✓	●	●	●		●		Multi	S100	258
AFV61841 -R long	3,0 - 25,0	4	✓		○	●	○		○		35 - 38°	TiAlN	259
AFV60341 long	3,0 - 25,0	4			○	●	○		○		35 - 38°	TiAlN	260
AFV61646 long	3,0 - 25,0	4			●	●	●		●		Multi	S100	261
AFV61851 long	6,0 - 25,0	5			○	●	○		○		35 - 38°	TiAlN	262
AFV60266 long	3,0 - 25,0	6			●	●	●		●		45°	S100	263
AFV60266 extra long	6,0 - 25,0	6	✓		●	●	●		●		45°	S100	264
AFV60861 -R long	6,0 - 25,0	6	✓	✓	●	●	●		●		45°	S100	265
AFV60862 -R extra long	6,0 - 25,0	6	✓	✓	●	●	●		●		45°	S100	266
<b>AFX</b>													
AFX50124 -R Mini	0,2 - 20,0	2	✓		●		●			●	30°	S100	278
AFX50120 short	0,1 - 20,0	2			●		●			●	30°	S100	282
AFX50121 long	1,0 - 20,0	2			●		●			●	30°	S100	284
AFX50121 -R long	1,0 - 20,0	2	✓		●		●			●	30°	S100	286
AFX50122 extra long	0,2 - 12,0	2			●		●			●	30°	S100	288
AFX50321 long	0,1 - 20,0	2			●		●			●	30°	S100	291
AFX52021 long	0,2 - 12,0	2			●		●			●	30°	S100	294
AFX50140 short	1,0 - 25,0	4		✓	●		●			●	26 - 30°	S100	297
AFX50041 -R long	1,0 - 20,0	4	✓	✓	●		●			●	30 - 38°	S100	299
AFX50741 -R long	1,0 - 20,0	4	✓	✓	●		●			●	30°	S100	302
AFX50042 extra long	1,0 - 20,0	4		✓	●		●			●	35 - 38°	S100	304
AFX50141 long	1,0 - 25,0	4		✓	●		●			●	30°	S100	305
AFX50142 extra long	1,0 - 12,0	4		✓	●		●			●	30°	S100	307
AFX50260 short	6,0 - 20,0	6		✓	●		●			●	45°	S100	309
<b>Powder metal milling cutters</b>													
<b>FP</b>													
FP60120 short	2,0 - 25,0	2		✓	●	●	●		○	<40	30°	TiAlN	332
FP60121 long	2,0 - 25,0	2		✓	●	●	●		○	<40	30°	TiAlN	333
FP60320 short	2,0 - 25,0	2		✓	●	●	●		○	<40	30°	TiAlN	334
FP60135 extra short	3,0 - 25,0	2		✓	●	●	●		○	<40	30°	TiAlN	335
FP60130 short	2,0 - 25,0	3		✓	●	●	●		○	<40	30°	TiAlN	336
FP601.0 short	2,0 - 25,0	3		✓	●	●	●		○	<40	30°	TiAlN	337
FP601.1 long	2,0 - 32,0	4 - 6		✓	●	●	●		○	<40	30°	TiAlN	338
FP618.0 short	2,0 - 32,0	4 - 6		✓	●	●	●		○	<40	30°	TiAlN	339
FP618.6 mittellong	6,0 - 32,0	3 - 6		< ∅ 20	●	●	●		○	<40	30°	TiAlN	340
FP618.1 long	6,0 - 32,0	3 - 6		< ∅ 20	●	●	●		○	<40	30°	TiAlN	341
FP619.5 extra short	6,0 - 25,0	3 - 6		< ∅ 20	●	●	●		○	<40	30°	TiAlN	342
FP619.0 short	4,0 - 25,0	4 - 6		< ∅ 20	●	●	●		○	<40	45°	TiAlN	343
FP620.0 short	6,0 - 32,0	3 - 6		< ∅ 20	●	●	●		○	<40	45°	TiAlN	344
FP623.1 extra long	6,0 - 32,0	3 - 6		< ∅ 20	●	●	●		○	<40	30°	TiAlN	345

● = Main application  
○ = Suitable

Dimensions in mm

Modèle	Diamètre D	Dents z	Rayon R	Perçage possible	P	M	K	N	S	H [HRC]	Angle d'hélice	Revêtement	Page
<b>Fraise à queue en carbure monobloc</b>													
<b>AF</b>													
AF50526 mini	0,4 - 4,0	2		✓	●		●				30°	TiAIN	30
AF52021 mini	0,4 - 4,0	2		✓	●		●				30°	TiAIN	32
AF60125 courte	2,0 - 20,0	2		✓	●	●	●				30°	TiAIN	34
AF50120 -R courte	2,0 - 12,0	2	✓	✓	●	●	●				30°	TiAIN	35
AF50121 longue	2,0	2		✓	●	●	●				30°	TiAIN	37
AF60121 longue	2,8 - 20,0	2		✓	●	●	●				30°	TiAIN	37
AF50121 -R longue	3,0 - 12,0	2	✓	✓	●	●	●				30°	TiAIN	39
AF50122 extra longue	3,0 - 20,0	2		✓	●	●	●				30°	TiAIN	40
AF60320 courte	2,0 - 20,0	2		✓	●		●				30°	TiAIN	41
AF50321 longue	3,0 - 20,0	2		✓	●		●				30°	TiAIN	42
AF60321 longue	3,0 - 20,0	2		✓	●		●				30°	TiAIN	43
AF50322 extra longue	3,0 - 20,0	2		✓	●		●				30°	TiAIN	44
AF50135 extra courte	0,5 - 1,8	3		✓	●	●	●				30°	TiAIN	45
AF60135 extra courte	2,0 - 20,0	3		✓	●	●	●				30°	TiAIN	45
AF61330 courte	2,0 - 20,0	3		✓	●	●	●				30°	TiAIN	47
AF60131 longue	3,0 - 20,0	3		✓	●	●	●				30°	TiAIN	48
AF60231 longue	3,0 - 20,0	3		✓	●	●	●				45°	TiAIN	49
AF50140 courte	1,0 - 20,0	4		✓	●	●	●				30°	TiAIN	50
AF50140 -R courte	2,0 - 12,0	4	✓	✓	●	●	●				30°	TiAIN	51
AF60140 courte	2,0 - 20,0	4		✓	●	●	●				30°	TiAIN	53
AF50141 longue	2,0	4		✓	●	●	●				30°	TiAIN	54
AF60141 longue	3,0 - 20,0	4		✓	●	●	●				30°	TiAIN	54
AF50141 -R longue	3,0 - 12,0	4	✓	✓	●	●	●				30°	TiAIN	56
AF50142 extra longue	3,0 - 20,0	4		✓	●	●	●				30°	TiAIN	57
AF60142 extra longue	6,0 - 10,0	4		✓	●	●	●				30°	TiAIN	57
AF50340 courte	2,0 - 20,0	4		✓	●		●		○		30°	TiAIN	59
AF502.0 courte	3,0 - 20,0	4 - 6		✓	●	●	●				45°	TiAIN	60
AF50261 longue	12,0 - 20,0	6		✓	●	●	●				45°	TiAIN	61
AF614.1 longue	6,0 - 25,0	3 - 5		✓	●	●			○		30°	TiAIN	62
<b>AFA</b>													
AFA50116 mi-longue	2,0 - 12,0	1		✓				●			30°	TiCN	74
AFA50220 courte	3,0 - 20,0	2		✓				●			45°	TiCN	75
AFA51820 courte	6,0 - 20,0	2		✓				●			50°	TiCN	76
AFA51521 longue	3,0 - 20,0	2		✓				●			45°	uncoated	77
AFA50720 -R longue	4,0 - 20,0	2	✓	✓				●			30°	TiCN	78
AFA51522 extra longue	1,0 - 20,0	2		✓				●			45°	TiCN	79
AFA50222 extra longue	1,0 - 20,0	2		✓				●			45°	TiCN	80
AFA51836 mi-longue	6,0 - 20,0	3		✓				●			45°	TiCN	82
AFA52336 mi-longue	3,0 - 20,0	3		✓				●			45°	TiCN	83
AFA52330 longue	3,5 - 20,0	3		✓				●			30°	uncoated	84
AFA51531 longue	3,0 - 20,0	3		✓				●			45°	TiCN	85
AFA50231 -R longue	3,0 - 20,0	3	✓	✓				●			45°	TiCN	86
AFA51532 extra longue	3,0 - 20,0	3		✓				●			45°	TiCN	87
AFA50232 extra longue	1,0 - 20,0	3		✓				●			45°	TiCN	89
AFA51831 courte	2,0 - 20,0	3		✓				●			40°	TiCN	92
AFA61431 longue	6,0 - 25,0	3		✓				●			30°	uncoated	93
AFA51431 longue	6,0 - 25,0	3		✓				●			30°	TiCN	94
AFA52131 longue	4,0 - 20,0	3		✓				●			42°	TiCN	95
AFA51931 longue	4,0 - 20,0	3		✓				●			45°	TiCN	96
AFA52331 longue	4,0 - 20,0	3		✓				●			45°	TiCN	97
<b>AFD</b>													
AFD50724 -R mini	0,2 - 6,0	2	✓	✓							30°	Diamant	108
AFD50121 longue	0,5 - 12,0	2		✓							30°	Diamant	110
AFD51824 mini	0,2 - 6,0	2		✓							30°	Diamant	111
AFD54030 -R courte	2,0 - 12,0	3	✓	✓							40°	Diamant	113

● = Application principale  
○ = Utilisation secondaire

Modèle	Diamètre D	Dents z	Rayon R	Perçage possible	P	M	K	N	S	H [HRC]	Angle d'hélice	Revêtement	Page	
<b>AFE</b>														
AFE51840 -R courte	6,0 - 25,0	4	✓	✓	●					●	Usinage du graphite	Multi	E200	124
AFE51850 courte	6,0 - 25,0	5	✓	✓	●					●		Multi	E200	126
AFE51850 -R courte	6,0 - 25,0	5	✓	✓	●					●		Multi	E200	127
AFE51851 longue	6,0 - 25,0	5	✓	✓	●					●		Multi	E200	128
AFE51851 -R longue	6,0 - 25,0	5	✓	✓	●					●		Multi	E200	129
AFE52451 -R longue	6,0 - 25,0	5	✓	✓	●					●		40°	E200	131
<b>AFG</b>														
AFG50120 courte	2,0 - 25,0	2		✓	●	●				<50	30°	TiAIN	140	
AFG50121 longue	2,0 - 25,0	2		✓	●					<50	30°	TiAIN	141	
AFG50321 longue	2,0 - 25,0	2		✓	●					<50	30°	TiAIN	142	
AFG50322	1,0 - 12,0	2			●					<50	30°	TiAIN	143	
AFG52021 longue	0,4 - 6,0	2			●					<50	30°	TiAIN	144	
AFG51621 longue	3,0 - 12,0	2			●					<50	30°	TiAIN	147	
AFG50134 mini	1,5 - 12,0	3			●	●				<50	30°	TiAIN	148	
AFG60134 mini	1,5 - 12,0	3			●	●				<50	30°	TiAIN	148	
AFG50745 -R	2,0 - 16,0	4	✓		●	●				<50	30°	TiAIN	149	
AFG50140 courte	2,0 - 25,0	4			●	●				<50	30°	TiAIN	150	
AFG60140 courte	2,0 - 20,0	4			●	●				<50	30°	TiAIN	151	
AFG50741 -R longue	3,0 - 20,0	4	✓		●					<50	30°	TiAIN	152	
AFG50141 longue	2,0 - 25,0	4			●					<50	30°	TiAIN	154	
AFG60141 longue	3,0 - 25,0	4			●					<50	30°	TiAIN	155	
AFG502.0 longue	4,0 - 25,0	4 - 8			●					<50	45°	TiAIN	156	
AFG602.0 longue	4,0 - 25,0	4 - 8			●					<50	45°	TiAIN	157	
AFG50861 -R longue	6,0 - 20,0	6	✓	✓	●					<50	45°	TiAIN	158	
AFG50262 extra longue	6,0 - 25,0	6			●					<50	45°	TiAIN	159	
AFG60262 extra longue	6,0 - 25,0	6			●					<50	45°	TiAIN	160	
AFG606.0 courte	6,0 - 25,0	3 - 5			●					<50	20°	TiAIN	161	
AFG606.1 longue	6,0 - 25,0	3 - 5			●					<50	20°	TiAIN	162	
<b>AFH</b>														
AFH50120 -R mini	0,3 - 2,0	2	✓	✓	●					●	30°	TiA70	174	
AFH50526 mini	0,1 - 4,0	2		✓	●					●	30°	TiA70	175	
AFH50920 -R mini	0,5 - 2,0	2	✓	✓	●					●	30°	TiA70	177	
AFH50320 mini	0,4 - 2,0	2		✓	●					●	30°	TiA70	178	
AFH52020 mini	0,5 - 2,0	2		✓	●					●	30°	TiA70	179	
AFH52021 mini	0,1 - 4,0	2		✓	●					●	30°	TiA70	180	
AFH50125	0,1 - 20,0	2		✓	●					●	30°	TiA70	182	
AFH50725 -R	0,5 - 20,0	2	✓	✓	●					●	30°	TiA70	184	
AFH50926 -R	0,5 - 12,0	2	✓	✓	●					●	30°	TiA70	186	
AFH51625	1,0 - 25,0	2		✓	●					●	30°	TiA70	189	
AFH51626	0,1 - 12,0	2		✓	●					●	30°	TiA70	191	
AFH51635	3,0 - 20,0	3		✓	●					●	30°	TiA70	193	
AFH50140	1,0 - 20,0	4			●					●	30°	TiA70	194	
AFH50142 -R	6,0 - 12,0	4	✓		●					●	30°	TiA70	195	
AFH50146 -R	3,0 - 12,0	4	✓		●					●	30°	TiA70	196	
AFH50745 -R	1,0 - 20,0	4	✓		●					●	30°	TiA70	198	
AFH50341	3,0 - 20,0	4		✓	●					●	30°	TiA70	200	
AFH50865 -R	6,0 - 20,0	6	✓		●					●	45°	TiA70	201	
AFH508.1 longue	6,0 - 25,0	6 - 8		✓	●					●	45°	TiA70	202	
AFH508.2 extra longue	6,0 - 25,0	6 - 8		✓	●					●	45°	TiA70	203	
AFH50746 -R courte	2,0 - 12,0	4	✓		●					●	90°	TiA70	204	
AFH50741 -R longue	2,0 - 16,0	4	✓		●					●	90°	TiA70	205	
<b>AFJ</b>														
AFJ612.1 longue	3,0 - 25,0	3 - 4		✓	○	●				●	50°	TiAIN	226	
AFJ602.0 longue	3,0 - 20,0	4 - 8			○	●				●	45°	TiAIN	227	
AFJ619.1 longue	4,0 - 25,0	3 - 6			○	●				●	45°	TiAIN	228	

● = Application principale  
○ = Utilisation secondaire

Toutes les dimensions en mm

Modèle	Diamètre D	Dents z	Rayon R	Perçage possible	P	M	K	N	S	H [HRC]	Angle d'hélice	Revêtement	Page
<b>AFR</b>													
AFR619.0 courte	6,0 - 20,0	4 - 5	✓	✓	●	●	●			<40	43 - 46°	AlCrN	238
AFR619.1 extra longue	6,0 - 20,0	4 - 5	✓	✓	●	●	●			<40	43 - 46°	AlCrN	239
AFR619.2 longue	6,0 - 20,0	4 - 5	✓	✓	●	●	●			<40	43 - 46°	AlCrN	240
AFR619.3 longue	6,0 - 20,0	4 - 5			●	●	●			<40	43 - 46°	TiAlN	241
<b>AFV</b>													
AFV61840 -R courte	3,0 - 20,0	4			○	●	○		○		35 - 38°	TiAlN	248
AFV61840 courte	3,0 - 20,0	4		✓	●	●	●		●		Multi	S100	249
AFV61840 -R courte	3,0 - 20,0	4	✓	✓	●	●	●		●		Multi	S100	250
AFV61840 -R courte	3,0 - 20,0	4	✓		○	●	○		○		35 - 38°	TiAlN	251
AFV62342 courte	3,0 - 20,0	4			●	●	●		●		35 - 38°	S100	252
AFV62342 -R courte	3,0 - 20,0	4	✓		●	●	●		●		35 - 38°	S100	254
AFV61841 -R longue	3,0 - 25,0	4		✓	●	●	●		●		Multi	S100	256
AFV61841 longue	3,0 - 25,0	4			○	●	○		○		35 - 38°	TiAlN	257
AFV61841 -R longue	3,0 - 25,0	4	✓	✓	●	●	●		●		Multi	S100	258
AFV61841 -R longue	3,0 - 25,0	4	✓		○	●	○		○		35 - 38°	TiAlN	259
AFV60341 longue	3,0 - 25,0	4			○	●	○		○		35 - 38°	TiAlN	260
AFV61646 longue	3,0 - 25,0	4			●	●	●		●		Multi	S100	261
AFV61851 longue	6,0 - 25,0	5			○	●	○		○		35 - 38°	TiAlN	262
AFV60266 longue	3,0 - 25,0	6			●	●	●		●		45°	S100	263
AFV60266 extra longue	6,0 - 25,0	6	✓		●	●	●		●		45°	S100	264
AFV60861 -R longue	6,0 - 25,0	6	✓	✓	●	●	●		●		45°	S100	265
AFV60862 -R extra longue	6,0 - 25,0	6	✓	✓	●	●	●		●		45°	S100	266
<b>AFX</b>													
AFX50124 -R mini	0,2 - 20,0	2	✓		●		●			●	30°	S100	278
AFX50120 courte	0,1 - 20,0	2			●					●	30°	S100	282
AFX50121 longue	1,0 - 20,0	2			●		●			●	30°	S100	284
AFX50121 -R longue	1,0 - 20,0	2	✓		●		●			●	30°	S100	286
AFX50122 extra longue	0,2 - 12,0	2			●		●			●	30°	S100	288
AFX50321 longue	0,1 - 20,0	2			●		●			●	30°	S100	291
AFX52021 longue	0,2 - 12,0	2			●		●			●	30°	S100	294
AFX50140 courte	1,0 - 25,0	4		✓	●		●			●	26 - 30°	S100	297
AFX50041 -R longue	1,0 - 20,0	4	✓	✓	●		●			●	30 - 38°	S100	299
AFX50741 -R longue	1,0 - 20,0	4	✓	✓	●		●			●	30°	S100	302
AFX50042 extra longue	1,0 - 20,0	4		✓	●		●			●	35 - 38°	S100	304
AFX50141 longue	1,0 - 25,0	4		✓	●		●			●	30°	S100	305
AFX50142 extra longue	1,0 - 12,0	4		✓	●		●			●	30°	S100	307
AFX50260 courte	6,0 - 20,0	6		✓	●		●			●	45°	S100	309
<b>Fraise à queue PM-HSS</b>													
<b>FP</b>													
FP60120 courte	2,0 - 25,0	2		✓	●	●	●		○	<40	30°	TiAlN	332
FP60121 longue	2,0 - 25,0	2		✓	●	●	●		○	<40	30°	TiAlN	333
FP60320 courte	2,0 - 25,0	2		✓	●	●	●		○	<40	30°	TiAlN	334
FP60135 extra courte	3,0 - 25,0	2		✓	●	●	●		○	<40	30°	TiAlN	335
FP60130 courte	2,0 - 25,0	3		✓	●	●	●		○	<40	30°	TiAlN	336
FP601.0 courte	2,0 - 25,0	3		✓	●	●	●		○	<40	30°	TiAlN	337
FP601.1 longue	2,0 - 32,0	4 - 6		✓	●	●	●		○	<40	30°	TiAlN	338
FP618.0 courte	2,0 - 32,0	4 - 6		✓	●	●	●		○	<40	30°	TiAlN	339
FP618.6 mittellongue	6,0 - 32,0	3 - 6		< ø 20	●	●	●		○	<40	30°	TiAlN	340
FP618.1 longue	6,0 - 32,0	3 - 6		< ø 20	●	●	●		○	<40	30°	TiAlN	341
FP619.5 extra courte	6,0 - 25,0	3 - 6		< ø 20	●	●	●		○	<40	30°	TiAlN	342
FP619.0 courte	4,0 - 25,0	4 - 6		< ø 20	●	●	●		○	<40	45°	TiAlN	343
FP620.0 courte	6,0 - 32,0	3 - 6		< ø 20	●	●	●		○	<40	45°	TiAlN	344
FP623.1 extra longue	6,0 - 32,0	3 - 6		< ø 20	●	●	●		○	<40	30°	TiAlN	345

● = Application principale  
○ = Utilisation secondaire

Toutes les dimensions en mm

# ARNO®

## WERKZEUGE

We have a passion for precision.

## VOLLHARTMETALL-SCHAFTFRÄSER

*Solid carbide end-mills*

Fraises à queue en carbure monobloc

### Ausführung

- AF** - für Stahl und Gusswerkstoffe
- AFA** - für Aluminium und NE-Metalle
- AFD** - für Graphit und NE-Metalle
- AFE** - Hochgeschwindigkeitsbearbeitung von exotischen Materialien (Titan, Inconel) und rostfreien Stählen.
- AFG** - für Stahl und gehärtete Stähle bis 50 HRC
- AFH** - für gehärtete Stähle bis 70 HRC und HSC-Bearbeitung
- AFJ** - für rostfreie Stähle und exotische Werkstoffe
- AFR** - für Stahl, Werkzeugstahl, Guss-eisen und gehärtete Werkstoffe
- AFV** - mit ungleicher Drallsteigung (35°–38°)
- AFX** - für gehärtete Stähle bis 55 HRC, Stahl und Gusseisen
- AFE** - Hochgeschwindigkeitsbearbeitung von exotischen Materialien (Titan, Inconel) und rostfreien Stählen.

### Design

- AF** - for steel and cast materials
- AFA** - for aluminium and non-ferrous machining
- AFD** - for graphite and non-ferrous materials
- AFE** - for high speed machining of exotic materials (Titanium, Inconel) and stainless steels.
- AFG** - for steel and hardened steel up to 50 HRC
- AFH** - for hardened steel up to 70 HRC and high speed milling
- AFJ** - for stainless steel and exotic materials
- AFR** - for steel, tool steel, cast iron and pre-hardened steel to 40 HRC
- AFV** - with unequal pitch (35°–38°)
- AFX** - for pre-hardened steels up to 55 HRC, steel and cast iron

### Modèle









- AF** - pour acier et fonte
- AFA** - pour aluminium et métaux non ferreux
- AFE** - Usinage à grande vitesse des matériaux exotiques (titane, Inconel) et des aciers inoxydables.
- AFD** - pour graphite et métaux non ferreux
- AFG** - pour acier et aciers trempés jusqu'à 50 HRC
- AFH** - pour aciers trempés jusqu'à 70 HRC et usinage à grande vitesse
- AFJ** - pour aciers inoxydables et matériaux exotiques
- AFR** - pour acier, acier à outils, fonte et matériaux trempés
- AFV** - avec pas décalé (35° – 38°)
- AFX** - pour aciers trempés jusqu'à 55 HRC, acier et fonte



# Übersicht Vollhartmetallfräser

Overview Solid carbide milling cutter

Aperçu fraise en carbure monobloc

Bezeichnung Description Désignation	Schneiden Flutes Nombre de dents	Fräser typ Type Type de fraise	Ausführung Design Modèle	Spiralwinkel Helix angle Angle d'hélice	Abb. Picture Fig.	Seite Page Page
<b>AF - für Stahl und Gusswerkstoffe / for steel and cast materials / pour matériaux en acier et en fonte</b>						
AF50526-...	2	<b>Schaftfräser</b> End-mill Fraise à queue	mini	30°		<b>30</b>
AF52021-...	2	<b>Radiusfräser</b> Ball-nose end-mill hémisphérique	mini	30°		<b>32</b>
AF60125-...	2	<b>Schaftfräser</b> End-mill Fraise à queue	<b>kurz</b> short courte	30°		<b>34</b>
AF50120-...R...	2	<b>Schaftfräser</b> End-mill Fraise à queue	<b>kurz, mit Eckenradius</b> short, with corner radius courte, rayonnée	30°		<b>35</b>
AF50121-... / AF60121-...	2	<b>Schaftfräser</b> End-mill Fraise à queue	<b>lang</b> long longue	30°		<b>37</b>
AF50121-...R...	2	<b>Schaftfräser</b> End-mill Fraise à queue	<b>lang, mit Eckenradius</b> long, with corner radius longue, rayonnée	30°		<b>39</b>
AF50122-...	2	<b>Schaftfräser</b> End-mill Fraise à queue	<b>extra lang</b> extra long extra longue	30°		<b>40</b>
AF60320-...	2	<b>Radiusfräser</b> Ball-nose end-mill hémisphérique	<b>kurz</b> short courte	30°		<b>41</b>
AF50321-...	2	<b>Radiusfräser</b> Ball-nose end-mill hémisphérique	<b>lang</b> long longue	30°		<b>42</b>
AF60321-...	2	<b>Radiusfräser</b> Ball-nose end-mill hémisphérique	<b>lang</b> long longue	30°		<b>43</b>
AF50322-...	2	<b>Radiusfräser</b> Ball-nose end-mill hémisphérique	<b>extra lang</b> extra long extra longue	30°		<b>44</b>



# Übersicht Vollhartmetallfräser

Overview Solid carbide milling cutter  
Aperçu fraise en carbure monobloc

Bezeichnung Description Désignation	Schneiden Flutes Nombre de dents	Fräsertyp Type Type de fraise	Ausführung Design Modèle	Spiralwinkel Helix angle Angle d'hélice	Abb. Picture Fig.	Seite Page Page
<b>AF - für Stahl und Gusswerkstoffe / for steel and cast materials / pour matériaux en acier et en fonte</b>						
<b>AF50135-... / AF60135-...</b>	3	<b>Schaftfräser</b> <i>End-mill</i> Fraise à queue	<b>extra kurz</b> extra short super courte	30°		<b>45</b>
<b>AF61330-...</b>	3	<b>Schaftfräser</b> <i>End-mill</i> Fraise à queue	<b>kurz</b> short courte	30°		<b>47</b>
<b>AF60131-...</b>	3	<b>Schaftfräser</b> <i>End-mill</i> Fraise à queue	<b>lang</b> long longue	30°		<b>48</b>
<b>AF60231-...</b>	3	<b>Schaftfräser</b> <i>End-mill</i> Fraise à queue	<b>lang</b> long longue	45°		<b>49</b>
<b>AF50140-...</b>	4	<b>Schaftfräser</b> <i>End-mill</i> Fraise à queue	<b>kurz</b> short courte	30°		<b>50</b>
<b>AF50140-...R...</b>	4	<b>Schaftfräser</b> <i>End-mill</i> Fraise à queue	<b>kurz, mit Eckenradius</b> short, with corner radius courte, rayonnée	30°		<b>51</b>
<b>AF60140-...X</b>	4	<b>Schaftfräser</b> <i>End-mill</i> Fraise à queue	<b>kurz</b> short courte	30°		<b>53</b>
<b>AF50141-... / AF60141-...</b>	4	<b>Schaftfräser</b> <i>End-mill</i> Fraise à queue	<b>lang</b> long longue	30°		<b>54</b>
<b>AF50141-...R...</b>	4	<b>Schaftfräser</b> <i>End-mill</i> Fraise à queue	<b>lang, mit Eckenradius</b> long, with corner radius longue, rayonnée	30°		<b>56</b>
<b>AF50142-...X / AF60142-...X</b>	4	<b>Schaftfräser</b> <i>End-mill</i> Fraise à queue	<b>extra lang</b> extra long extra longue	30°		<b>57</b>
<b>AF50340-...</b>	4	<b>Radiusfräser</b> <i>Ball-nose end-mill</i> hémisphérique	<b>kurz</b> short courte	30°		<b>59</b>

# Übersicht Vollhartmetallfräser

Overview Solid carbide milling cutter

Aperçu fraise en carbure monobloc

Bezeichnung Description Désignation	Schneiden Flutes Nombre de dents	Fräser typ Type Type de fraise	Ausführung Design Modèle	Spiralwinkel Helix angle Angle d'hélice	Abb. Picture Fig.	Seite Page Page
<b>AF - für Stahl und Gusswerkstoffe / for steel and cast materials / pour matériaux en acier et en fonte</b>						
AF502.0-...	4 - 6	<b>Schaftfräser</b> End-mill Fraise à queue	<b>kurz</b> short courte	45°		<b>60</b>
AF50261-...	6	<b>Schaftfräser</b> End-mill Fraise à queue	<b>lang</b> long longue	45°		<b>61</b>
AF614.1-...	3 - 5	<b>Schrupfräser</b> Roughing end-mill Fraise à queue	<b>lang</b> long longue	30°		<b>62</b>
<b>AFA - für Aluminium und NE-Metalle / for aluminium and non-ferrous machining / pour aluminium et métaux non ferreux</b>						
AFA50116-...	1	<b>Schaftfräser</b> End-mill Fraise à queue	<b>mittellang</b> mid-length mi-longue	30°		<b>74</b>
AFA50220-...	2	<b>Schaftfräser</b> End-mill Fraise à queue	<b>kurz</b> short courte	45°		<b>75</b>
AFA51820-...	2	<b>Radiusfräser</b> Ball-nose end-mill hémisphérique	<b>kurz</b> short courte	50°		<b>76</b>
AFA51521-...	2	<b>Schaftfräser</b> End-mill Fraise à queue	<b>lang</b> long longue	45°		<b>77</b>
AFA50720-...R...	2	<b>Schaftfräser</b> End-mill Fraise à queue	<b>lang, mit Eckenradius</b> long, with corner radius longue, rayonnée	30°		<b>78</b>
AFA51522-...	2	<b>Schaftfräser</b> End-mill Fraise à queue	<b>extra lang</b> extra long extra longue	45°		<b>79</b>
AFA50222-...	2	<b>Schaftfräser</b> End-mill Fraise à queue	<b>extra lang</b> extra long extra longue	45°		<b>80</b>

# Übersicht Vollhartmetallfräser

Overview Solid carbide milling cutter

Aperçu fraise en carbure monobloc

Bezeichnung Description Désignation	Schneiden Flutes Nombre de dents	Fräser typ Type Type de fraise	Ausführung Design Modèle	Spiralwinkel Helix angle Angle d'hélice	Abb. Picture Fig.	Seite Page Page
AFA51836-...	3	<b>Schaftfräser</b> End-mill Fraise à queue	<b>mittellang</b> mid-length mi-longue	45°		<b>82</b>
AFA52336-...	3	<b>Schaftfräser</b> End-mill Fraise à queue	<b>mittellang, abgesetzter Schaft</b> mid-length, with neck mi-longue, avec détalonnage	45°		<b>83</b>
AFA52330-...	3	<b>Schaftfräser</b> End-mill Fraise à queue	<b>lang</b> long longue	30°		<b>84</b>
AFA51531-...	3	<b>Schaftfräser</b> End-mill Fraise à queue	<b>lang</b> long longue	45°		<b>85</b>
AFA50231-...R...	3	<b>Schaftfräser</b> End-mill Fraise à queue	<b>lang, mit Eckenradius</b> long, with corner radius longue, rayonnée	45°		<b>86</b>
AFA51532-...	3	<b>Schaftfräser</b> End-mill Fraise à queue	<b>extra lang</b> extra long extra longue	45°		<b>87</b>
AFA50232-...	3	<b>Schaftfräser</b> End-mill Fraise à queue	<b>extra lang</b> extra long extra longue	45°		<b>89</b>
AFA51831-...	3	<b>Radiusfräser</b> Ball-nose end-mill hémisphérique	<b>kurz</b> short courte	40°		<b>92</b>
AFA61431-...	3	<b>Schruppfräser</b> Roughing end-mill Fraise à queue	<b>lang</b> long longue	30°		<b>94</b>
AFA51431-...	3	<b>Schruppfräser</b> Roughing end mill Fraise d'ébauche	<b>lang</b> long longue	30°		<b>95</b>

# Übersicht Vollhartmetallfräser

Overview Solid carbide milling cutter

Aperçu fraise en carbure monobloc

Bezeichnung Description Désignation	Schneiden Flutes Nombre de dents	Fräser typ Type Type de fraise	Ausführung Design Modèle	Spiralwinkel Helix angle Angle d'hélice	Abb. Picture Fig.	Seite Page Page
AFA52131-...	3	<b>Schruppfräser</b> <i>Roughing end mill</i> Fraise d'ébauche	<b>lang</b> <i>long</i> longue	42°		<b>95</b>
AFA51931-...	3	<b>Schruppfräser</b> <i>Roughing end mill</i> Fraise d'ébauche	<b>lang</b> <i>long</i> longue	45°		<b>96</b>
AFA52331-...	3	<b>Schruppfräser</b> <i>Roughing end mill</i> Fraise d'ébauche	<b>lang, abgesetzter Schaft</b> <i>long, with neck</i> longue, tige dégagée	45°		<b>97</b>
<b>AFD - für Graphit und NE-Metalle / for graphite and non-ferrous materials / pour graphite et métaux non ferreux</b>						
AFD50724-...R...	2	<b>Schaftfräser</b> <i>End-mill</i> Fraise à queue	<b>mini, mit Eckenradius</b> <i>mini, with corner radius</i> mini, rayonnée	30°		<b>108</b>
AFD50121-...	2	<b>Schaftfräser</b> <i>End-mill</i> Fraise à queue	<b>lang</b> <i>long</i> longue	30°		<b>110</b>
AFD51824-...	2	<b>Radiusfräser</b> <i>Ball-nose End-mill</i> hémisphérique	mini	30°		<b>111</b>
AFD54030-...R...	2	<b>Schaftfräser</b> <i>End-mill</i> Fraise à queue	mini	30°		<b>113</b>
<b>AFE - für exotische Werkstoffe und rostfreie Stähle / for high speed machining of exotic materials and stainless steels / Usinage à grande vitesse des matériaux exotiques et des aciers inoxydables.</b>						
AFE51840-...(R)...	4	<b>Schaftfräser</b> <i>End-mill</i> Fraise à queue	mit Eckenradius with corner radius	Multi		<b>124</b>
AFE51850-...	5	<b>Schaftfräser</b> <i>End-mill</i> Fraise à queue	<b>kurz</b> <i>short</i> courte	Multi		<b>126</b>
AFE51850-...(R)...	5	<b>Schaftfräser</b> <i>End-mill</i> Fraise à queue	<b>mit Eckenradius</b> <i>with corner radius</i> rayonnée	Multi		<b>127</b>

# Übersicht Vollhartmetallfräser

Overview Solid carbide milling cutter

Aperçu fraise en carbure monobloc

Bezeichnung Description Désignation	Schneiden Flutes Nombre de dents	Fräser typ Type Type de fraise	Ausführung Design Modèle	Spiralwinkel Helix angle Angle d'hélice	Abb. Picture Fig.	Seite Page Page
AFE51851-... <b>NEU/NEW NOUVEAU</b>	5	<b>Schaftfräser</b> End-mill Fraise à queue	<b>lang</b> long longue	Multi		<b>128</b>
AFE51851-...(R)... <b>NEU/NEW NOUVEAU</b>	5	<b>Schaftfräser</b> End-mill Fraise à queue	<b>mit Eckenradius</b> with corner radius rayonnée	Multi		<b>129</b>
AFE52451-...(R)... <b>NEU/NEW NOUVEAU</b>	5	<b>Schrupfräser</b> Roughing end mill Fraise d'ébauche	<b>mit Eckenradius</b> with corner radius rayonnée	40°		<b>131</b>
<b>AFG - für Stahl und gehärtete Stähle bis 50 HRC / for steel and hardened steel up to 50 HRC / pour acier et aciers trempés jusqu'à 50 HRC</b>						
AFG50120-...	2	<b>Schaftfräser</b> End-mill Fraise à queue	<b>kurz</b> short courte	30°		<b>140</b>
AFG50121-...	2	<b>Schaftfräser</b> End-mill Fraise à queue	<b>lang</b> long longue	30°		<b>141</b>
AFG50321-...	2	<b>Radiusfräser</b> Ball-nose end-mill hémisphérique	<b>lang</b> long longue	30°		<b>142</b>
AFG50322-...	2	<b>Radiusfräser</b> Ball-nose end-mill hémisphérique	<b>konischer Schaftteil</b> taper neck partie de tige conique	30°		<b>143</b>
AFG52021-...	2	<b>Radiusfräser</b> Ball-nose end-mill hémisphérique	<b>lang (Schlitzfräsen)</b> long (slotting) longue (rainureuses)	30°		<b>144</b>
AFG51621-...	2	<b>Radiusfräser</b> Ball-nose end-mill hémisphérique	<b>lang</b> long longue	30°		<b>147</b>
AFG50134-.../ AFG60134-...	3	<b>Schaftfräser</b> End-mill Fraise à queue	mini	30°		<b>148</b>
AFG50745-...R...	4	<b>Schaftfräser</b> End-mill Fraise à queue	<b>mit Eckenradius</b> with corner radius rayonnée	30°		<b>149</b>

# Übersicht Vollhartmetallfräser

Overview Solid carbide milling cutter

Aperçu fraise en carbure monobloc

Bezeichnung Description Désignation	Schneiden Flutes Nombre de dents	Fräser typ Type Type de fraise	Ausführung Design Modèle	Spiralwinkel Helix angle Angle d'hélice	Abb. Picture Fig.	Seite Page Page
AFG50140-...	4	<b>Schaftfräser</b> End-mill Fraise à queue	<b>kurz</b> short courte	30°		<b>150</b>
AFG60140-...	4	<b>Schaftfräser</b> End-mill Fraise à queue	<b>kurz</b> short courte	30°		<b>151</b>
AFG50741-...R...	4	<b>Schaftfräser</b> End-mill Fraise à queue	<b>lang, mit Eckenradius</b> long, with corner radius longue, rayonnée	30°		<b>152</b>
AFG50141-...	4	<b>Schaftfräser</b> End-mill Fraise à queue	<b>lang</b> long longue	30°		<b>154</b>
AFG60141-...	4	<b>Schaftfräser</b> End-mill Fraise à queue	<b>lang</b> long longue	30°		<b>155</b>
AFG502.0-...	4 - 8	<b>Schaftfräser</b> End-mill Fraise à queue	<b>lang</b> long longue	45°		<b>156</b>
AFG602.0-...	4 - 8	<b>Schaftfräser</b> End-mill Fraise à queue	<b>extra lang</b> extra long extra longue	45°		<b>157</b>
AFG50861-...R...	6	<b>Schaftfräser</b> End-mill Fraise à queue	<b>lang, mit Eckenradius</b> long, with corner radius longue, rayonnée	45°		<b>158</b>
AFG50262-...	6	<b>Schaftfräser</b> End-mill Fraise à queue	<b>extra lang</b> extra long extra longue	45°		<b>159</b>
AFG60262-...	6	<b>Schaftfräser</b> End-mill Fraise à queue	<b>extra lang</b> extra long extra longue	45°		<b>160</b>
AFG606.0-...	3 - 5	<b>Schrupfräser</b> Roughing end mill Fraise d'ébauche	<b>kurz</b> short courte	20°		<b>161</b>

# Übersicht Vollhartmetallfräser



Overview Solid carbide milling cutter  
Aperçu fraise en carbure monobloc

Bezeichnung Description Désignation	Schneiden Flutes Nombre de dents	Fräsertyp Type Type de fraise	Ausführung Design Modèle	Spiralwinkel Helix angle Angle d'hélice	Abb. Picture Fig.	Seite Page Page
<b>AFG606.1-...</b>	3 - 5	<b>Schruppfräser</b> <i>Roughing end mill</i> Fraise d'ébauche	<b>lang</b> <i>long</i> longue	20°		<b>162</b>
<b>AFJ - für rostfreie Stähle und exotische Werkstoffe / for stainless steel and exotic materials / pour aciers inoxydables et matériaux exotiques</b>						
<b>AFJ612.1-...</b>	3 - 4	<b>Schaftfräser</b> <i>End-mill</i> Fraise à queue	<b>lang</b> <i>long</i> longue	50°		<b>226</b>
<b>AFJ602.0-...</b>	4 - 8	<b>Schaftfräser</b> <i>End-mill</i> Fraise à queue	<b>kurz</b> <i>short</i> courte	45°		<b>227</b>
<b>AFJ619.1-...</b>	3 - 6	<b>Schruppfräser</b> <i>Roughing end-mill</i> Fraise à queue	<b>lang</b> <i>long</i> longue	45°		<b>228</b>
<b>AFR - für Stahl, Werkzeugstahl, Gusseisen und gehärtete Werkstoffe / for steel, tool steel, cast iron and pre-hardened steel / pour acier, acier à outils, fonte et matériaux trempés</b>						
<b>AFR619.0-...</b>	4 - 5	<b>Schruppfräser</b> <i>Roughing end mill</i> Fraise d'ébauche	<b>kurz</b> <i>short</i> courte	43 - 46°		<b>238</b>
<b>AFR619.1-...</b>	4 - 5	<b>Schruppfräser</b> <i>Roughing end mill</i> Fraise d'ébauche	<b>extra lang</b> <i>extra long</i> extra longue	43 - 46°		<b>239</b>
<b>AFR619.2-...</b>	4 - 5	<b>Schruppfräser</b> <i>Roughing end mill</i> Fraise d'ébauche	<b>lang</b> <i>long</i> longue	43 - 46°		<b>240</b>
<b>AFR619.3-...-PM</b>	4 - 5	<b>Schruppfräser</b> <i>Roughing end mill</i> Fraise d'ébauche	<b>lang</b> <i>long</i> longue	43 - 46°		<b>241</b>
<b>AFH - für gehärtete Stähle bis 70 HRC und HSC-Bearbeitung / for hardened steel up to 70 HRC and high speed milling / pour aciers trempés jusqu'à 70 HRC et usinage à grande vitesse</b>						
<b>AFH50120...R...</b>	2	<b>Schaftfräser</b> <i>End-mill</i> Fraise à queue	mini	30°		<b>174</b>
<b>AFH50526-...</b>	2	<b>Schaftfräser</b> <i>End-mill</i> Fraise à queue	<b>mini (Schlitzfräsen)</b> <i>mini (slotting)</i> mini (rainureuses)	30°		<b>175</b>

# Übersicht Vollhartmetallfräser

Overview Solid carbide milling cutter

Aperçu fraise en carbure monobloc

Bezeichnung Description Désignation	Schneiden Flutes Nombre de dents	Fräsertyp Type Type de fraise	Ausführung Design Modèle	Spiralwinkel Helix angle Angle d'hélice	Abb. Picture Fig.	Seite Page Page
AFH50920-...R...	2	<b>Schaftfräser</b> End-mill Fraise à queue	<b>mini (Schlitzfräsen)</b> mini (slotting) mini (rainureuses)	30°		<b>177</b>
AFH50320-...	2	<b>Radiusfräser</b> Ball-nose end-mill hémisphérique	mini	30°		<b>178</b>
AFH52020-...	2	<b>Radiusfräser</b> Ball-nose end-mill hémisphérique	<b>mini (Schlitzfräsen)</b> mini (slotting) mini (rainureuses)	30°		<b>179</b>
AFH52021-...	2	<b>Radiusfräser</b> Ball-nose end-mill hémisphérique	<b>mini (Schlitzfräsen)</b> mini (slotting) mini (rainureuses)	30°		<b>180</b>
AFH50125-...	2	<b>Schaftfräser</b> End-mill Fraise à queue		30°		<b>182</b>
AFH50725-...R...	2	<b>Schaftfräser</b> End-mill Fraise à queue	<b>mit Eckenradius</b> with corner radius Fraise à queue	30°		<b>184</b>
AFH50926-...R...	2	<b>Schaftfräser</b> End-mill Fraise à queue	<b>mit Eckenradius</b> with corner radius Fraise à queue	30°		<b>186</b>
AFH51625-...	2	<b>Radiusfräser</b> Ball-nose end-mill hémisphérique		30°		<b>189</b>
AFH51626-...	2	<b>Radiusfräser</b> Ball-nose end-mill hémisphérique		30°		<b>191</b>
AFH51635-...	3	<b>Radiusfräser</b> Ball-nose end-mill hémisphérique		30°		<b>193</b>
AFH50140-...	4	<b>Schaftfräser</b> End-mill Fraise à queue		30°		<b>194</b>



# Übersicht Vollhartmetallfräser

Overview Solid carbide milling cutter

Aperçu fraise en carbure monobloc

Bezeichnung Description Désignation	Schneiden Flutes Nombre de dents	Fräsertyp Type Type de fraise	Ausführung Design Modèle	Spiralwinkel Helix angle Angle d'hélice	Abb. Picture Fig.	Seite Page Page
AFH50142-...R...	4	<b>Schaftfräser</b> End-mill Fraise à queue	<b>mit Eckenradius</b> with corner radius Fraise à queue	30°		<b>195</b>
AFH50146-...R...	4	<b>Schaftfräser</b> End-mill Fraise à queue	<b>mit Eckenradius</b> with corner radius Fraise à queue	30°		<b>196</b>
AFH50745-...R...	4	<b>Schaftfräser</b> End-mill Fraise à queue	<b>mit Eckenradius</b> with corner radius Fraise à queue	30°		<b>198</b>
AFH50341-...	4	<b>Radiusfräser</b> Ball-nose end-mill hémisphérique		30°		<b>200</b>
AFH50865-...R...	6	<b>Schaftfräser</b> End-mill Fraise à queue	<b>mit Eckenradius</b> with corner radius Fraise à queue	45°		<b>201</b>
AFH508.1-...	6 - 8	<b>Schaftfräser</b> End-mill Fraise à queue	<b>lang</b> long longue	45°		<b>202</b>
AFH508.2-...	6 - 8	<b>Schaftfräser</b> End-mill Fraise à queue	<b>extra lang</b> extra long extra longue	45°		<b>203</b>
AFH50746-...R...	4	<b>Hochvorschubfräser</b> High feed end-mill Fraise à haute avance	<b>kurz, mit Eckenradius</b> short, with corner radius courte, rayonnée	90°		<b>204</b>
AFH50741-...R...	4	<b>Hochvorschubfräser</b> High feed end-mill Fraise à haute avance	<b>lang, mit Eckenradius</b> long, with corner radius longue, rayonnée	90°		<b>205</b>
<b>AFV - mit ungleicher Drallsteigung (26°-30° / 35°-38°) / with unequal pitch (26° - 30° / 35° - 38°) / avec pas inégal (26° - 30° / 35° - 38°)</b>						
AFV61840-...(R)... (TiAlN)	4	<b>Schaftfräser</b> End-mill Fraise à queue	<b>kurz, mit Eckenradius</b> short, with corner radius courte, rayonnée	35° - 38°		<b>250</b>
AFV61840-...R... (S100)	4	<b>Schaftfräser</b> End-mill Fraise à queue	<b>kurz, mit Eckenradius</b> short, with corner radius courte, rayonnée	35° - 38°		<b>251</b>

# Übersicht Vollhartmetallfräser

Overview Solid carbide milling cutter

Aperçu fraise en carbure monobloc

Bezeichnung Description Désignation	Schneiden Flutes Nombre de dents	Fräser typ Type Type de fraise	Ausführung Design Modèle	Spiralwinkel Helix angle Angle d'hélice	Abb. Picture Fig.	Seite Page Page
AFV62342-... (S100)	4	<b>Schaftfräser</b> End-mill Fraise à queue	<b>kurz</b> short courte	35 - 38°		<b>252</b>
AFV62342-...R... (S100)	4	<b>Schaftfräser</b> End-mill Fraise à queue	<b>kurz</b> short courte	35 - 38°		<b>254</b>
AFV61841-...R... (TiAlN)	4	<b>Schaftfräser</b> End-mill Fraise à queue	<b>lang, mit Eckenradius</b> long, with corner radius longue, rayonnée	35° - 38°		<b>258</b>
AFV61841-...R... (S100)	4	<b>Schaftfräser</b> End-mill Fraise à queue	<b>lang, mit Eckenradius</b> long, with corner radius longue, rayonnée	35 - 38°		<b>259</b>
AFV60341-... (TiAlN)	4	<b>Radiusfräser</b> Ball-nose end-mill hémisphérique	<b>lang</b> long longue	35° - 38°		<b>260</b>
AFV61851-... (TiAlN)	5	<b>Schaftfräser</b> End-mill Fraise à queue	<b>lang</b> long longue	35° - 38°		<b>262</b>
<b>AFX - für gehärtete Stähle bis 55 HRC, Stahl und Gusseisen / for pre-hardened steels up to 55 HRC, steel and cast iron / pour aciers trempés jusqu'à 55 HRC, acier et fonte</b>						
AFX50124-...R...	2	<b>Schaftfräser</b> End-mill Fraise à queue	<b>mini, mit Eckenradius</b> mini, with corner radius mini, rayonnée	30°		<b>278</b>
AFX50120-...	2	<b>Schaftfräser</b> End-mill Fraise à queue	<b>kurz</b> short court	30°		<b>282</b>
AFX50121-...	2	<b>Schaftfräser</b> End-mill Fraise à queue	<b>lang</b> long longue	30°		<b>284</b>
AFX50121-...R...	2	<b>Schaftfräser</b> End-mill Fraise à queue	<b>lang, mit Eckenradius</b> long, with corner radius longue, rayonnée	30°		<b>286</b>

# Übersicht Vollhartmetallfräser

Overview Solid carbide milling cutter  
Aperçu fraise en carbure monobloc

Bezeichnung Description Désignation	Schneiden Flutes Nombre de dents	Fräser typ Type Type de fraise	Ausführung Design Modèle	Spiralwinkel Helix angle Angle d'hélice	Abb. Picture Fig.	Seite Page Page
AFX50122-...	2	<b>Schaftfräser</b> End-mill Fraise à queue	<b>extra lang</b> extra long extra longue	30°		<b>288</b>
AFX50321-...	2	<b>Radiusfräser</b> Ball-nose end-mill hémisphérique	<b>lang</b> long longue	30°		<b>291</b>
AFX52021-...	2	<b>Radiusfräser</b> Ball-nose end-mill hémisphérique	<b>lang, Schlitzfräsen</b> long, slotting longue, rainureuses	30°		<b>294</b>
AFX50140-...	4	<b>Schaftfräser</b> End-mill Fraise à queue	<b>kurz</b> short court	26 - 30°		<b>297</b>
AFX50041-...R...	4	<b>Schaftfräser</b> End-mill Fraise à queue	<b>lang, mit Eckenradius</b> long, with corner radius longue, rayonnée	30 - 38°		<b>299</b>
AFX50741-...R...	4	<b>Schaftfräser</b> End-mill Fraise à queue	<b>lang, mit Eckenradius</b> long, with corner radius longue, rayonnée	30°		<b>302</b>
AFX50042-...	4	<b>Schaftfräser</b> End-mill Fraise à queue	<b>extra lang</b> extra long extra longue	35 - 38°		<b>304</b>
AFX50141-...	4	<b>Schaftfräser</b> End-mill Fraise à queue	<b>lang</b> long longue	30°		<b>305</b>
AFX50142-...	4	<b>Schaftfräser</b> End-mill Fraise à queue	<b>extra lang</b> extra long extra longue	30°		<b>307</b>
AFX50260-...	6	<b>Schaftfräser</b> End-mill Fraise à queue	<b>kurz</b> short court	45°		<b>309</b>

## Weitere Highlights unserer Frässysteme.

*Other highlights from our milling range.*

*Autres points forts de notre gamme de fraisage.*



### **ARNO®-Frässystem DUO-MILL**

**Eckfräsen und HFC-Fräsen mit nur einem Werkzeug.**

*ARNO® milling-system DUO-MILL*

*Square shoulder and high feed (HFC) milling with just one tool.*

Système de fraisage ARNO® DUO-MILL

Fraisage à 90° et grande avance avec un seul outil



### **ARNO®-Frässystem FTA**

**Der universelle Planfräser zur Kostenreduzierung.**

*ARNO® milling-system FTA*

*Face milling tool for cost reduction.*

Système de fraisage ARNO® FTA

Le surfacage rentable !



### **ARNO®-Frässystem FOA**

**Der positiv weichschneidende Planfräser, der eine Rundplatte und eine oktagonale Wendschneidplatte in einem Plattensitz vereint.**

*ARNO® milling-system FOA*

*The positive face-milling-cutter, in which both a round and an octogonal insert can be used.*

Système de fraisage ARNO® FOA

La fraise polyvalente qui peut recevoir des plaquettes octogonales ou rondes, angle d'attaque positif pour une coupe douce et des efforts de coupe réduits au minimum.

**Weitere Informationen finden Sie unter**

*For more information see*

*Pour plus d'informations*

**ARNO®**  
**WERKZEUGE**

**www.arno.de**

# ARNO<sup>®</sup>

## WERKZEUGE

We have a passion for precision.

# AUSFÜHRUNG AF

*Design AF / Modèle AF*

**Perfekte Leistung.**  
*Great performance.*  
*Performance parfaite.*

**Vollhartmetallfräser für die allgemeine  
Bearbeitung von Stahl, rostfreiem Stahl  
und Gusswerkstoffen.**

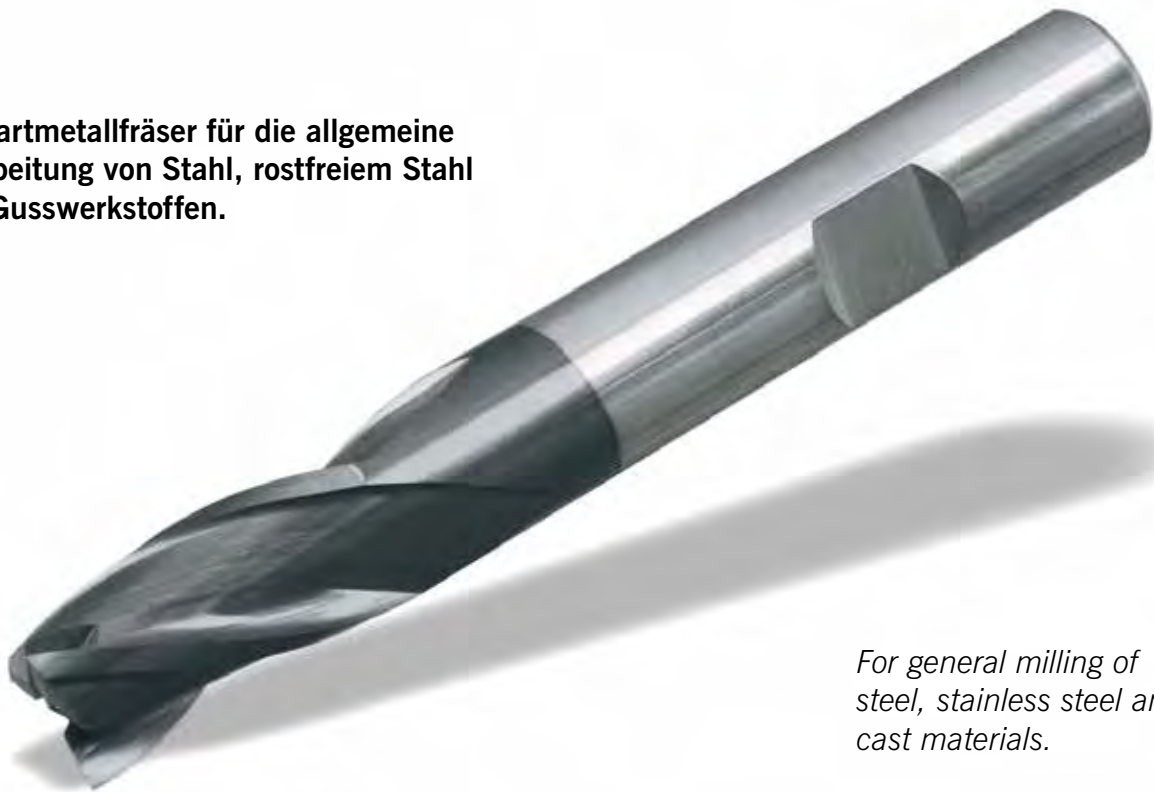

*For general milling of  
steel, stainless steel and  
cast materials.*

Fraise en carbure monobloc pour l'usinage général  
de l'acier, acier inoxydable et des fontes.

## AF50526-...

2 Schneiden, Mini-Ausführung / 2 flutes, mini design / 2 dents, version mini

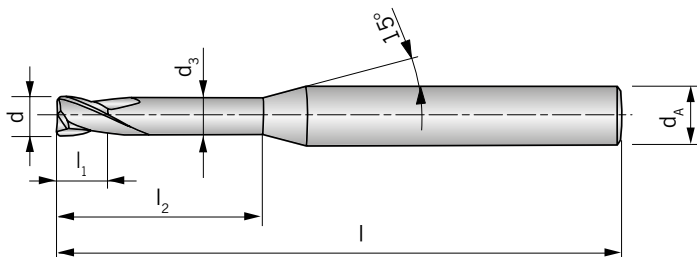

							PG 24
							beschichtet coated revêtu
Schaft DIN 6535HA Shank Tige	d -0,03	d <sub>A</sub> h6	d <sub>3</sub>	l <sub>1</sub>	l <sub>2</sub>	l	TiAlN
AF50526-004A	0,4	4	0,37	0,70	2	50	●
AF50526-004B	0,4	4	0,37	0,70	4	50	●
AF50526-005A	0,5	4	0,45	0,75	2	50	●
AF50526-005B	0,5	4	0,45	0,75	4	50	●
AF50526-005C	0,5	4	0,45	0,75	6	50	●
AF50526-006A	0,6	4	0,55	0,90	2	50	●
AF50526-006B	0,6	4	0,55	0,90	4	50	●
AF50526-006C	0,6	4	0,55	0,90	6	50	●
AF50526-007A	0,7	4	0,65	1,10	4	50	●
AF50526-007B	0,7	4	0,65	1,10	6	50	●
AF50526-008A	0,8	4	0,75	1,20	4	50	●
AF50526-008B	0,8	4	0,75	1,20	6	50	●
AF50526-008C	0,8	4	0,75	1,20	8	50	●
AF50526-009A	0,9	4	0,85	1,40	6	50	●
AF50526-009B	0,9	4	0,85	1,40	8	50	●
AF50526-009C	0,9	4	0,85	1,40	10	50	●
AF50526-010A	1,0	4	0,95	1,50	6	50	●
AF50526-010B	1,0	4	0,95	1,50	8	50	●
AF50526-010C	1,0	4	0,95	1,50	10	50	●
AF50526-010D	1,0	4	0,95	1,50	12	50	●
AF50526-012A	1,2	4	1,15	1,80	6	50	●
AF50526-012B	1,2	4	1,15	1,80	8	50	●
AF50526-012C	1,2	4	1,15	1,80	10	50	●
AF50526-012D	1,2	4	1,15	1,80	12	50	●
AF50526-015A	1,5	4	1,45	2,30	6	50	●
AF50526-015B	1,5	4	1,45	2,30	8	50	●
AF50526-015C	1,5	4	1,45	2,30	10	50	●
AF50526-015D	1,5	4	1,45	2,30	12	50	●
AF50526-015E	1,5	4	1,45	2,30	14	50	●
AF50526-015F	1,5	4	1,45	2,30	16	50	●
AF50526-015G	1,5	4	1,45	2,30	18	50	●
AF50526-015H	1,5	4	1,45	2,30	20	50	●
AF50526-020A	2,0	4	1,95	3,00	6	50	●

							PG 24
							beschichtet coated revêtu
Schaft DIN 6535HA Shank Tige	d -0,03	d <sub>A</sub> h6	d <sub>3</sub>	l <sub>1</sub>	l <sub>2</sub>	l	TiAIN
AF50526-020B	2,0	4	1,95	3,00	8	50	●
AF50526-020C	2,0	4	1,95	3,00	10	50	●
AF50526-020D	2,0	4	1,95	3,00	12	50	●
AF50526-020E	2,0	4	1,95	3,00	14	50	●
AF50526-020F	2,0	4	1,95	3,00	16	50	●
AF50526-020G	2,0	4	1,95	3,00	18	50	●
AF50526-020H	2,0	4	1,95	3,00	20	50	●
AF50526-025A	2,5	4	2,40	3,70	8	50	●
AF50526-025B	2,5	4	2,40	3,70	12	50	●
AF50526-025C	2,5	4	2,40	3,70	16	50	●
AF50526-025D	2,5	4	2,40	3,70	20	50	●
AF50526-030A	3,0	6	2,85	4,50	8	50	●
AF50526-030B	3,0	6	2,85	4,50	12	50	●
AF50526-030C	3,0	6	2,85	4,50	16	60	●
AF50526-030D	3,0	6	2,85	4,50	20	60	●
AF50526-030E	3,0	6	2,85	4,50	25	75	●
AF50526-040A	4,0	6	3,85	6,00	12	50	●
AF50526-040B	4,0	6	3,85	6,00	16	60	●
AF50526-040C	4,0	6	3,85	6,00	20	75	●
AF50526-040D	4,0	6	3,85	6,00	25	75	●
AF50526-040E	4,0	6	3,85	6,00	30	75	●
AF50526-040F	4,0	6	3,85	6,00	35	75	●

P	●
M	
K	
N	
S	
H	

- **Hauptanwendung**  
Main application  
Application principale
- **Nebenanwendung**  
Secondary application  
Application secondaire

Solid carbide ball-nose end-mill  
Fraise carbure monobloc hémisphérique

## AF52021-...

2 Schneiden, Mini-Ausführung / 2 flutes, mini design / 2 dents, version mini

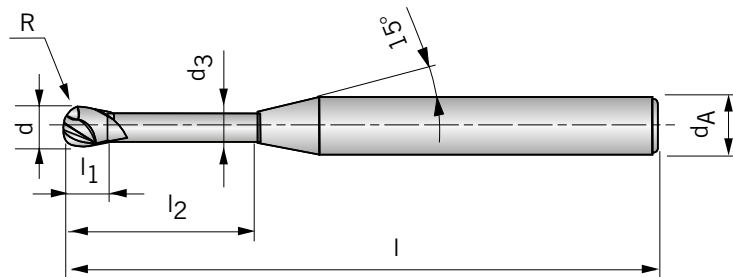

									PG 24
									beschichtet coated revêtu
Schaft DIN 6535HA Shank Tige	d -0,03	d <sub>A</sub> h6	d <sub>3</sub>	l <sub>1</sub>	l <sub>2</sub>	l	R ± 0,02	TiAlN	
AF52021-004A	0,4	4	0,37	0,70	2	50	0,20	●	
AF52021-005A	0,5	4	0,45	0,75	2	50	0,25	●	
AF52021-005B	0,5	4	0,45	0,75	4	50	0,25	●	
AF52021-005C	0,5	4	0,45	0,75	6	50	0,25	●	
AF52021-006A	0,6	4	0,55	0,90	2	50	0,30	●	
AF52021-006B	0,6	4	0,55	0,90	4	50	0,30	●	
AF52021-006C	0,6	4	0,55	0,90	6	50	0,30	●	
AF52021-008A	0,8	4	0,75	1,20	4	50	0,40	●	
AF52021-008B	0,8	4	0,75	1,20	6	50	0,40	●	
AF52021-008C	0,8	4	0,75	1,20	8	50	0,40	●	
AF52021-010A	1,0	4	0,95	1,50	6	50	0,50	●	
AF52021-010B	1,0	4	0,95	1,50	8	50	0,50	●	
AF52021-010C	1,0	4	0,95	1,50	10	50	0,50	●	
AF52021-010D	1,0	4	0,95	1,50	12	50	0,50	●	
AF52021-012A	1,2	4	1,15	1,80	8	50	0,60	●	
AF52021-012B	1,2	4	1,15	1,80	12	50	0,60	●	
AF52021-014A	1,4	4	1,35	2,10	16	50	0,70	●	
AF52021-015A	1,5	4	1,45	2,30	6	50	0,75	●	
AF52021-015B	1,5	4	1,45	2,30	8	50	0,75	●	
AF52021-015C	1,5	4	1,45	2,30	10	50	0,75	●	
AF52021-015D	1,5	4	1,45	2,30	12	50	0,75	●	
AF52021-015E	1,5	4	1,45	2,30	16	50	0,75	●	
AF52021-015F	1,5	4	1,45	2,30	20	50	0,75	●	
AF52021-016A	1,6	4	1,55	2,40	8	50	0,80	●	
AF52021-016B	1,6	4	1,55	2,40	12	50	0,80	●	
AF52021-016C	1,6	4	1,55	2,40	16	50	0,80	●	
AF52021-016D	1,6	4	1,55	2,40	20	50	0,80	●	
AF52021-020A	2,0	4	1,95	3,00	8	50	1,00	●	
AF52021-020B	2,0	4	1,95	3,00	10	50	1,00	●	
AF52021-020C	2,0	4	1,95	3,00	12	50	1,00	●	
AF52021-020D	2,0	4	1,95	3,00	14	50	1,00	●	
AF52021-020E	2,0	4	1,95	3,00	16	50	1,00	●	
AF52021-020F	2,0	4	1,95	3,00	20	50	1,00	●	



								PG 24
								beschichtet coated revêtu
Schaft DIN 6535HA Shank Tige	d -0,03	d <sub>A</sub> h6	d <sub>3</sub>	l <sub>1</sub>	l <sub>2</sub>	l	R ± 0,02	TITAIN
AF52021-030A	3,0	6	2,85	4,50	10	50	1,50	●
AF52021-030B	3,0	6	2,85	4,50	12	50	1,50	●
AF52021-030C	3,0	6	2,85	4,50	16	60	1,50	●
AF52021-030D	3,0	6	2,85	4,50	20	60	1,50	●
AF52021-030E	3,0	6	2,85	4,50	25	75	1,50	●
AF52021-040A	4,0	6	3,85	6,00	12	50	2,00	●
AF52021-040B	4,0	6	3,85	6,00	16	60	2,00	●
AF52021-040C	4,0	6	3,85	6,00	20	75	2,00	●
AF52021-040D	4,0	6	3,85	6,00	25	75	2,00	●
AF52021-040E	4,0	6	3,85	6,00	30	75	2,00	●

P	●
M	
K	
N	
S	
H	

- **Hauptanwendung**  
Main application  
Application principale
- **Nebenanwendung**  
Secondary application  
Application secondaire

Solid carbide end-mill

Fraise carbure monobloc à tige

## AF60125-...

2 Schneiden, kurze Ausführung / 2 flutes, short design / 2 dents, version courte

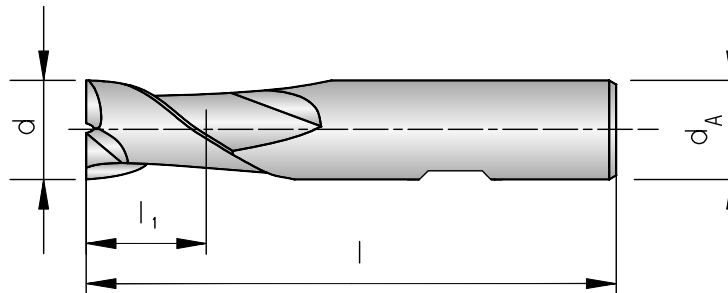

						PG 24
						beschichtet coated revêtu
Schaft DIN 6535HB Shank Tige	d -0,03	d <sub>A</sub> h6	l <sub>1</sub>	l	TiAlN	
AF60125-020	2,0	6	3	50	●	
AF60125-030	3,0	6	4	50	●	
AF60125-035	3,5	6	4	50	●	
AF60125-040	4,0	6	5	54	●	
AF60125-045	4,5	6	5	54	●	
AF60125-050	5,0	6	6	54	●	
AF60125-060	6,0	6	7	54	●	
AF60125-070	7,0	8	8	58	●	
AF60125-080	8,0	8	9	58	●	
AF60125-090	9,0	10	10	66	●	
AF60125-100	10,0	10	11	66	●	
AF60125-120	12,0	12	12	73	●	
AF60125-140	14,0	14	14	75	●	
AF60125-160	16,0	16	16	82	●	
AF60125-180	18,0	18	18	84	●	
AF60125-200	20,0	20	20	92	●	

P	●
M	●
K	●
N	
S	
H	

● Hauptanwendung  
Main application  
Application principale

○ Nebenanwendung  
Secondary application  
Application secondaire

## AF50120-...R...

2 Schneiden, kurze Ausführung mit Eckenradius / 2 flutes, short design with corner radius / 2 dents, version courte avec rayon d'angle

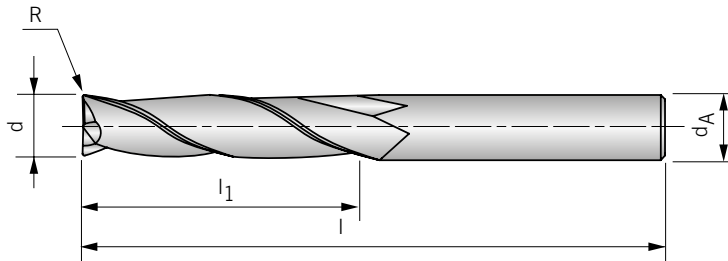
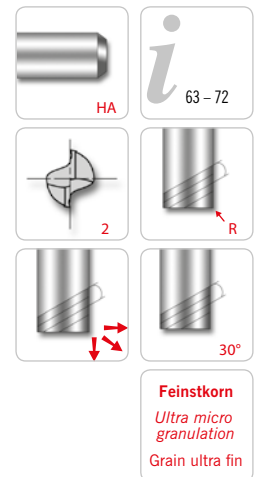

							PG 24
							beschichtet coated revêtu
Schaft DIN 6535HA Shank Tige	d -0,03	d <sub>A</sub> h6	l <sub>1</sub>	l	R ± 0,03	TiAIN	
AF50120-020R0,2	2,0	4	4	50	0,2	●	
AF50120-020R0,3	2,0	4	4	50	0,3	●	
AF50120-020R0,5	2,0	4	4	50	0,5	●	
AF50120-025R0,2	2,5	4	5	50	0,2	●	
AF50120-025R0,3	2,5	4	5	50	0,3	●	
AF50120-025R0,5	2,5	4	5	50	0,5	●	
AF50120-030R0,2	3,0	4	6	50	0,2	●	
AF50120-030R0,3	3,0	4	6	50	0,3	●	
AF50120-030R0,5	3,0	4	6	50	0,5	●	
AF50120-030R1,0	3,0	4	6	50	1,0	●	
AF50120-040R0,2	4,0	4	8	50	0,2	●	
AF50120-040R0,3	4,0	4	8	50	0,3	●	
AF50120-040R0,5	4,0	4	8	50	0,5	●	
AF50120-040R1,0	4,0	4	8	50	1,0	●	
AF50120-050R0,2	5,0	6	10	50	0,2	●	
AF50120-050R0,3	5,0	6	10	50	0,3	●	
AF50120-050R0,5	5,0	6	10	50	0,5	●	
AF50120-050R1,0	5,0	6	10	50	1,0	●	
AF50120-060R0,2	6,0	6	12	50	0,2	●	
AF50120-060R0,3	6,0	6	12	50	0,3	●	
AF50120-060R0,5	6,0	6	12	50	0,5	●	
AF50120-060R1,0	6,0	6	12	50	1,0	●	
AF50120-080R0,5	8,0	8	16	60	0,5	●	
AF50120-080R1,0	8,0	8	16	60	1,0	●	
AF50120-080R1,5	8,0	8	16	60	1,5	●	
AF50120-080R2,0	8,0	8	16	60	2,0	●	
AF50120-080R2,5	8,0	8	16	60	2,5	●	
AF50120-100R0,5	10,0	10	20	75	0,5	●	
AF50120-100R1,0	10,0	10	20	75	1,0	●	
AF50120-100R1,5	10,0	10	20	75	1,5	●	
AF50120-100R2,0	10,0	10	20	75	2,0	●	
AF50120-100R2,5	10,0	10	20	75	2,5	●	

							PG 24
							beschichtet coated revêtu
Schaft DIN 6535HA Shank Tige	d -0,03	d <sub>A</sub> h6	l <sub>1</sub>	l	R ± 0,03	TiAIN	
AF50120-120R0,5	12,0	12	24	75	0,5	●	
AF50120-120R1,0	12,0	12	24	75	1,0	●	
AF50120-120R1,5	12,0	12	24	75	1,5	●	
AF50120-120R2,0	12,0	12	24	75	2,0	●	
AF50120-120R2,5	12,0	12	24	75	2,5	●	

P	●
M	●
K	●
N	
S	
H	

- **Hauptanwendung**  
Main application  
Application principale
- **Nebenanwendung**  
Secondary application  
Application secondaire

## AF50121-... / AF60121-...

2 Schneiden, lange Ausführung / 2 flutes, long design / 2 dents, version longue

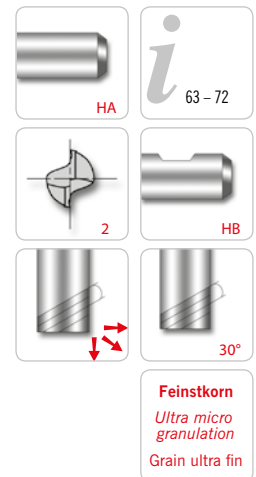
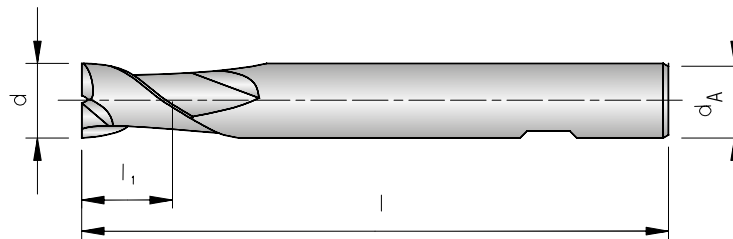

AF

						PG 24
						beschichtet coated revêtu
Schaft DIN 6535HA Shank Tige	d -0,03	d <sub>A</sub> h6	l <sub>1</sub>	l	TiAlN	
AF50121-020	2	3	6	38	●	

Zylinderschaft nach DIN 6535HA ohne Mitnahmefläche

Cylindrical shank to DIN 6535HA, no flat

Queue cylindrique conforme à la norme DIN 6535HA sans surface d'entraînement

P	●
M	●
K	●
N	
S	
H	

● Hauptanwendung  
Main application  
Application principale

○ Nebenanwendung  
Secondary application  
Application secondaire

						PG 24
						beschichtet coated revêtu
Schaft DIN 6535HB Shank Tige	d -0,03	d <sub>A</sub> h6	l <sub>1</sub>	l	TiAlN	
AF60121-028	2,80	6	7	57	●	
AF60121-030	3,00	6	7	57	●	
AF60121-035	3,50	6	7	57	●	
AF60121-038	3,80	6	8	57	●	
AF60121-040	4,00	6	8	57	●	
AF60121-045	4,50	6	8	57	●	
AF60121-048	4,80	6	10	57	●	
AF60121-050	5,00	6	10	57	●	
AF60121-055	5,50	6	10	57	●	
AF60121-057	5,75	6	10	57	●	
AF60121-060	6,00	6	10	57	●	

PG 24

beschichtet  
coated  
revêtu

Schaft DIN 6535HB Shank Tige	d -0,03	d <sub>A</sub> h6	l <sub>1</sub>	l	TiAIN
AF60121-065	6,50	8	13	63	●
AF60121-067	6,75	8	13	63	●
AF60121-070	7,00	8	13	63	●
AF60121-075	7,50	8	16	63	●
AF60121-077	7,75	8	16	63	●
AF60121-080	8,00	8	16	63	●
AF60121-087	8,70	10	16	72	●
AF60121-090	9,00	10	16	72	●
AF60121-095	9,50	10	19	72	●
AF60121-097	9,70	10	19	72	●
AF60121-100	10,00	10	19	72	●
AF60121-105	10,50	12	22	83	●
AF60121-110	11,00	12	22	83	●
AF60121-117	11,70	12	22	83	●
AF60121-120	12,00	12	22	83	●
AF60121-137	13,70	14	22	83	●
AF60121-140	14,00	14	22	83	●
AF60121-150	15,00	16	26	92	●
AF60121-157	15,70	16	26	92	●
AF60121-160	16,00	16	26	92	●
AF60121-177	17,70	18	26	92	●
AF60121-180	18,00	18	26	92	●
AF60121-197	19,70	20	32	104	●
AF60121-200	20,00	20	32	104	●

P	●
M	●
K	●
N	
S	
H	

● **Hauptanwendung**  
Main application  
Application principale

○ **Nebenanwendung**  
Secondary application  
Application secondaire

Solid carbide end-mill

Fraise carbure monobloc à tige

## AF50121-...R...

2 Schneiden, lange Ausführung mit Eckenradius / 2 flutes, long design with corner radius / 2 dents, version longue, avec rayon d'angle

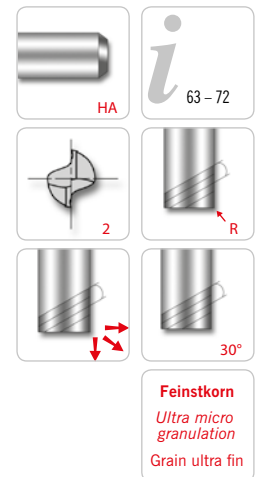
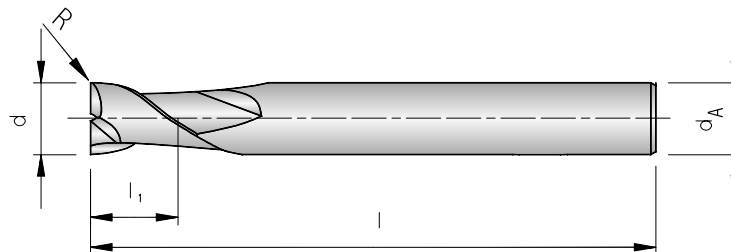

AF

							PG 24
							beschichtet coated revêtu
Schaft DIN 6535HA Shank Tige	d -0,03	d <sub>A</sub> h6	l <sub>1</sub>	l	R ± 0,03	TiAIN	
AF50121-030R0,5	3	4	6	75	0,5	●	
AF50121-030R1,0	3	4	6	75	1,0	●	
AF50121-040R0,5	4	4	8	75	0,5	●	
AF50121-040R1,0	4	4	8	75	1,0	●	
AF50121-050R0,5	5	6	10	75	0,5	●	
AF50121-050R1,0	5	6	10	75	1,0	●	
AF50121-060R0,5	6	6	12	75	0,5	●	
AF50121-060R1,0	6	6	12	75	1,0	●	
AF50121-080R0,5	8	8	16	100	0,5	●	
AF50121-080R1,0	8	8	16	100	1,0	●	
AF50121-080R1,5	8	8	16	100	1,5	●	
AF50121-080R2,0	8	8	16	100	2,0	●	
AF50121-080R2,5	8	8	16	100	2,5	●	
AF50121-100R0,5	10	10	20	100	0,5	●	
AF50121-100R1,0	10	10	20	100	1,0	●	
AF50121-100R1,5	10	10	20	100	1,5	●	
AF50121-100R2,0	10	10	20	100	2,0	●	
AF50121-100R2,5	10	10	20	100	2,5	●	
AF50121-120R0,5	12	12	24	100	0,5	●	
AF50121-120R1,0	12	12	24	100	1,0	●	
AF50121-120R1,5	12	12	24	100	1,5	●	
AF50121-120R2,0	12	12	24	100	2,0	●	
AF50121-120R2,5	12	12	24	100	2,5	●	

● Hauptanwendung  
Main application  
Application principale

○ Nebenanwendung  
Secondary application  
Application secondaire

P	●
M	●
K	●
N	
S	
H	

Solid carbide end-mill

Fraise carbure monobloc à tige

## AF50122-...

**2 Schneiden, extra lange Ausführung** / 2 flutes, extra long design / 2 dents, version extra longue

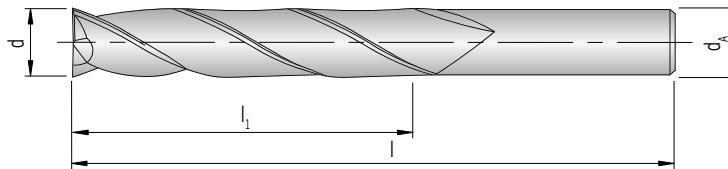

						PG 24
						beschichtet coated revêtu
Schaft DIN 6535HA Shank Tige	d -0,03	d <sub>A</sub> h6	l <sub>1</sub>	l	TITAIN	
AF50122-030	3	3	20	60	●	
AF50122-040	4	4	20	60	●	
AF50122-050	5	5	25	75	●	
AF50122-060	6	6	30	75	●	
AF50122-080	8	8	30	75	●	
AF50122-100	10	10	40	100	●	
AF50122-120	12	12	45	100	●	
AF50122-140	14	14	45	100	●	
AF50122-160	16	16	45	100	●	
AF50122-180	18	18	45	100	●	
AF50122-200	20	20	45	100	●	

P	●
M	●
K	●
N	
S	
H	

● **Hauptanwendung**  
Main application  
Application principale

○ **Nebenanwendung**  
Secondary application  
Application secondaire



Solid carbide ball-nose end-mill  
Fraise carbure monobloc hémisphérique

## AF60320-...

2 Schneiden, kurze Ausführung / 2 flutes, short design / 2 dents, version courte

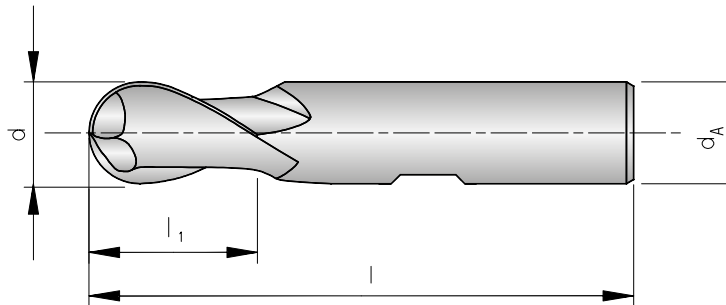

							PG 24
							beschichtet coated revêtu
Schaft DIN 6535HB Shank Tige	d -0,03	d <sub>A</sub> h6	l <sub>1</sub>	l	R ± 0,02	TiAIN	
AF60320-020	2	6	3	50	1,0	●	
AF60320-030	3	6	4	50	1,5	●	
AF60320-040	4	6	5	54	2,0	●	
AF60320-050	5	6	6	54	2,5	●	
AF60320-060	6	6	7	54	3,0	●	
AF60320-080	8	8	9	58	4,0	●	
AF60320-100	10	10	11	66	5,0	●	
AF60320-120	12	12	12	73	6,0	●	
AF60320-140	14	14	14	75	7,0	●	
AF60320-160	16	16	16	82	8,0	●	
AF60320-180	18	18	18	84	9,0	●	
AF60320-200	20	20	20	92	10,0	●	

P	●
M	
K	●
N	
S	
H	

● Hauptanwendung  
Main application  
Application principale

○ Nebenanwendung  
Secondary application  
Application secondaire

Solid carbide ball-nose end-mill  
Fraise carbure monobloc hémisphérique

## AF50321-...

2 Schneiden, lange Ausführung / 2 flutes, long design / 2 dents, version longue

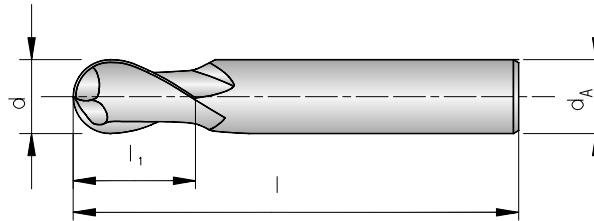

							PG 24
							beschichtet coated revêtu
Schaft DIN 6535HA Shank Tige	d -0,03	d <sub>A</sub> h6	l <sub>1</sub>	l	R ± 0,02	TiAIN	
AF50321-030	3	3	5	75	1,5	●	
AF50321-040	4	4	8	75	2,0	●	
AF50321-050	5	5	9	75	2,5	●	
AF50321-060	6	6	10	100	3,0	●	
AF50321-080	8	8	12	100	4,0	●	
AF50321-100	10	10	14	100	5,0	●	
AF50321-120	12	12	16	100	6,0	●	
AF50321-140	14	14	18	100	7,0	●	
AF50321-160	16	16	22	150	8,0	●	
AF50321-200	20	20	26	150	10,0	●	

P	●
M	
K	●
N	
S	
H	

● Hauptanwendung  
Main application  
Application principale  
○ Nebenanwendung  
Secondary application  
Application secondaire

Solid carbide ball-nose end-mill  
Fraise carbure monobloc hémisphérique

## AF60321-...

2 Schneiden, lange Ausführung / 2 flutes, long design / 2 dents, version longue

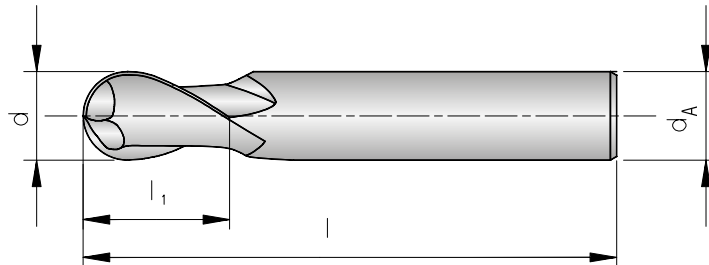

							PG 24
							beschichtet coated revêtu
Schaft DIN 6535HB Shank Tige	d -0,03	d <sub>A</sub> h6	l <sub>1</sub>	l	R ± 0,02	TiAIN	
AF60321-030	3	6	7	57	1,5	●	
AF60321-040	4	6	8	57	2,0	●	
AF60321-050	5	6	10	57	2,5	●	
AF60321-060	6	6	10	57	3,0	●	
AF60321-080	8	8	16	63	4,0	●	
AF60321-100	10	10	19	72	5,0	●	
AF60321-120	12	12	22	83	6,0	●	
AF60321-140	14	14	22	83	7,0	●	
AF60321-160	16	16	26	92	8,0	●	
AF60321-180	18	18	26	92	9,0	●	
AF60321-200	20	20	32	104	10,0	●	

P	●
M	
K	●
N	
S	
H	

● **Hauptanwendung**  
Main application  
Application principale

○ **Nebenanwendung**  
Secondary application  
Application secondaire

Solid carbide ball-nose end-mill  
Fraise carbure monobloc hémisphérique

## AF50322-...

**2 Schneiden, extra lange Ausführung** / 2 flutes, extra long design / 2 dents, version extra longue

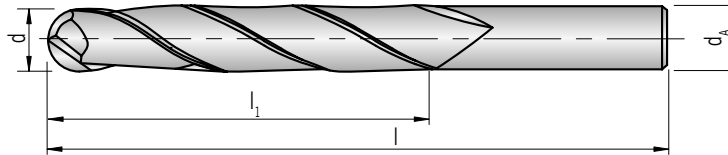

							PG 24
							beschichtet coated revêtu
Schaft DIN 6535HA Shank Tige	d -0,03	d <sub>A</sub> h6	l <sub>1</sub>	l	R ± 0,02	TiAIN	
AF50322-030	3	3	20	60	1,5	●	
AF50322-040	4	4	20	60	2,0	●	
AF50322-050	5	5	25	75	2,5	●	
AF50322-060	6	6	30	75	3,0	●	
AF50322-080	8	8	30	75	4,0	●	
AF50322-100	10	10	40	100	5,0	●	
AF50322-120	12	12	45	100	6,0	●	
AF50322-140	14	14	45	100	7,0	●	
AF50322-160	16	16	45	100	8,0	●	
AF50322-180	18	18	45	100	9,0	●	
AF50322-200	20	20	45	100	10,0	●	

P	●
M	
K	●
N	
S	
H	

● **Hauptanwendung**  
Main application  
Application principale

○ **Nebenanwendung**  
Secondary application  
Application secondaire

Solid carbide end-mill

Fraise carbure monobloc à tige

## AF50135-... / AF60135-...

3 Schneiden, extra kurze Ausführung / 3 flutes, extra short design / 3 dents, version extra courte

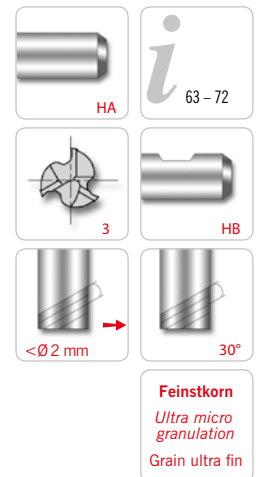
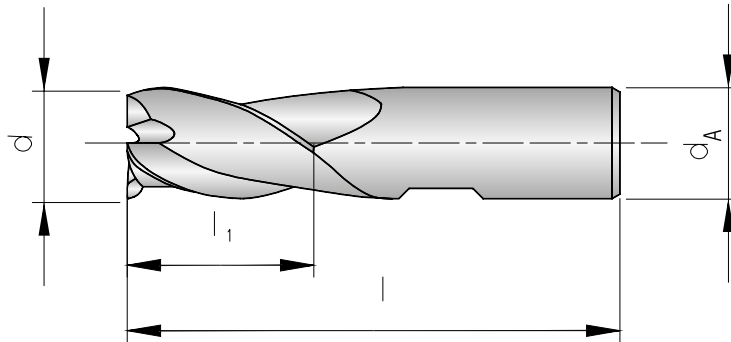

AF

						PG 24
						beschichtet coated revêtu
Schaft DIN 6535HA Shank Tige	d -0,03	d <sub>A</sub> h6	l <sub>1</sub>	l		TiAIN
AF50135-005	0,5	3	1,5	38		●
AF50135-006	0,6	3	1,5	38		●
AF50135-008	0,8	3	2,0	38		●
AF50135-010	1,0	3	2,0	38		●
AF50135-012	1,2	3	2,0	38		●
AF50135-015	1,5	3	2,0	38		●
AF50135-018	1,8	3	2,0	38		●

Zylinderschaft nach DIN 6535HA ohne Mitnahmefläche

Cylindrical shank to DIN 6535HA, no flat

Queue cylindrique conforme à la norme DIN 6535HA sans surface d'entraînement

P	●
M	●
K	●
N	
S	
H	

● Hauptanwendung  
Main application  
Application principale

○ Nebenanwendung  
Secondary application  
Application secondaire

						PG 24
						beschichtet coated revêtu
Schaft DIN 6535HB Shank Tige	d -0,03	d <sub>A</sub> h6	l <sub>1</sub>	l		TiAIN
AF60135-020	2,00	6	4	35		●
AF60135-025	2,50	6	5	36		●
AF60135-030	3,00	6	5	36		●
AF60135-035	3,50	6	6	37		●

PG 24

beschichtet  
coated  
revêtu

Schaft DIN 6535HB Shank Tige	d -0,03	d <sub>A</sub> h6	l <sub>1</sub>	l	TITAIN
AF60135-040	4,00	6	7	38	●
AF60135-045	4,50	6	8	38	●
AF60135-050	5,00	6	8	39	●
AF60135-055	5,50	6	8	39	●
AF60135-0575	5,75	6	8	39	●
AF60135-060	6,00	6	8	39	●
AF60135-065	6,50	8	10	42	●
AF60135-0675	6,75	8	10	42	●
AF60135-070	7,00	8	10	42	●
AF60135-075	7,50	8	11	43	●
AF60135-0775	7,75	8	10	42	●
AF60135-080	8,00	8	11	43	●
AF60135-085	8,50	10	13	50	●
AF60135-087	8,70	10	11	48	●
AF60135-090	9,00	10	11	48	●
AF60135-095	9,50	10	13	50	●
AF60135-097	9,70	10	11	48	●
AF60135-100	10,00	10	13	50	●
AF60135-105	10,50	12	15	55	●
AF60135-110	11,00	12	15	55	●
AF60135-115	11,50	12	15	55	●
AF60135-120	12,00	12	15	55	●
AF60135-130	13,00	14	15	58	●
AF60135-140	14,00	14	15	58	●
AF60135-150	15,00	16	18	62	●
AF60135-160	16,00	16	18	62	●
AF60135-180	18,00	18	20	70	●
AF60135-200	20,00	20	22	75	●

P	●
M	●
K	●
N	
S	
H	

● **Hauptanwendung**  
Main application  
Application principale

○ **Nebenanwendung**  
Secondary application  
Application secondaire

Solid carbide end-mill  
Fraise carbure monobloc à tige

## AF61330-...

3 Schneiden, kurze Ausführung / 3 flutes, short design / 3 dents, version courte

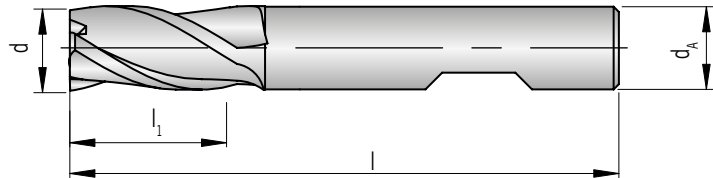

						PG 24
						beschichtet coated revêtu
Schaft DIN 6535HB Shank Tige	d -0,03	d <sub>A</sub> h6	l <sub>1</sub>	l	TiAlN	
AF61330-020	2,0	6	3	50	●	
AF61330-030	3,0	6	4	50	●	
AF61330-035	3,5	6	4	50	●	
AF61330-040	4,0	6	5	54	●	
AF61330-045	4,5	6	5	54	●	
AF61330-050	5,0	6	6	54	●	
AF61330-060	6,0	6	7	54	●	
AF61330-070	7,0	8	8	58	●	
AF61330-080	8,0	8	9	58	●	
AF61330-090	9,0	10	10	66	●	
AF61330-100	10,0	10	11	66	●	
AF61330-120	12,0	12	12	73	●	
AF61330-140	14,0	14	14	75	●	
AF61330-160	16,0	16	16	82	●	
AF61330-180	18,0	18	18	84	●	
AF61330-200	20,0	20	20	92	●	

P	●
M	●
K	●
N	
S	
H	

● Hauptanwendung  
Main application  
Application principale

○ Nebenanwendung  
Secondary application  
Application secondaire

Solid carbide end-mill

Fraise carbure monobloc à tige

## AF60131-...

3 Schneiden, lange Ausführung / 3 flutes, long design / 3 dents, version longue

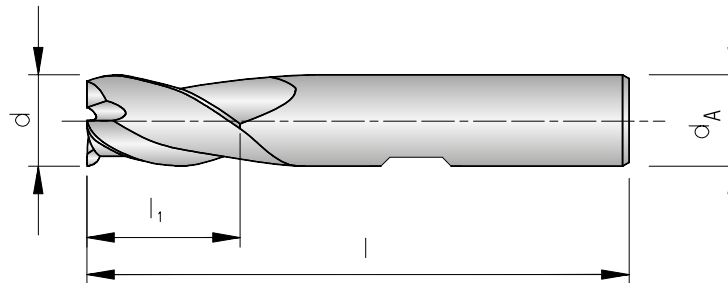

						PG 24
						beschichtet coated revêtu
Schaft DIN 6535HB Shank Tige	d -0,03	d <sub>A</sub> h6	l <sub>1</sub>	l	TiAIN	
AF60131-030	3	6	7	57	●	
AF60131-040	4	6	8	57	●	
AF60131-050	5	6	10	57	●	
AF60131-060	6	6	10	57	●	
AF60131-080	8	8	16	63	●	
AF60131-090	9	10	16	72	●	
AF60131-100	10	10	19	72	●	
AF60131-120	12	12	22	83	●	
AF60131-140	14	14	22	83	●	
AF60131-160	16	16	26	92	●	
AF60131-180	18	18	26	92	●	
AF60131-200	20	20	32	104	●	

P	●
M	●
K	●
N	
S	
H	

● **Hauptanwendung**  
Main application  
Application principale

○ **Nebenanwendung**  
Secondary application  
Application secondaire



Solid carbide end-mill  
Fraise carbure monobloc à tige

## AF60231-...

3 Schneiden, lange Ausführung / 3 flutes, long design / 3 dents, version longue

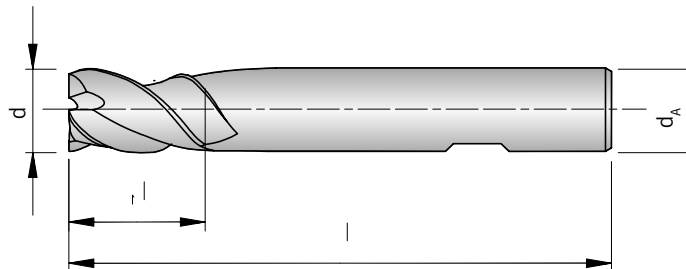

AF

						PG 24
						beschichtet coated revêtu
Schaft DIN 6535HB Shank Tige	d -0,03	d <sub>A</sub> h6	l <sub>1</sub>	l	TiAIN	
AF60231-030	3,0	6	7	57	●	
AF60231-035	3,5	6	7	57	●	
AF60231-040	4,0	6	8	57	●	
AF60231-045	4,5	6	8	57	●	
AF60231-050	5,0	6	10	57	●	
AF60231-060	6,0	6	10	57	●	
AF60231-070	7,0	8	13	63	●	
AF60231-080	8,0	8	16	63	●	
AF60231-090	9,0	10	16	72	●	
AF60231-100	10,0	10	19	72	●	
AF60231-120	12,0	12	22	83	●	
AF60231-140	14,0	14	22	83	●	
AF60231-160	16,0	16	26	92	●	
AF60231-180	18,0	18	26	92	●	
AF60231-200	20,0	20	32	104	●	

P	●
M	●
K	●
N	
S	
H	

● Hauptanwendung  
Main application  
Application principale  
○ Nebenanwendung  
Secondary application  
Application secondaire

Solid carbide end-mill  
Fraise carbure monobloc à tige

## AF50140-...

4 Schneiden, kurze Ausführung / 4 flutes, short design / 4 dents, version courte

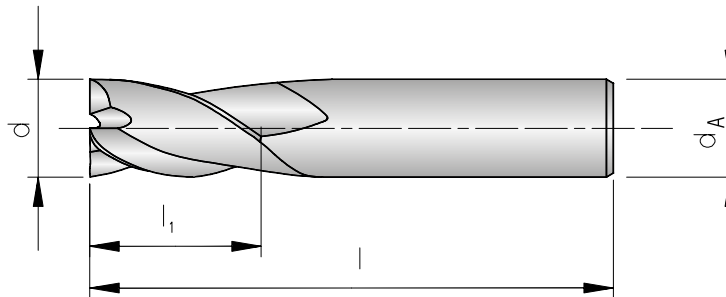
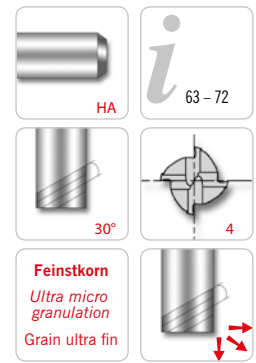

						PG 24
						beschichtet coated revêtu
Schaft DIN 6535HA Shank Tige	d -0,03	d <sub>A</sub> h6	l <sub>1</sub>	l	TiAIN	
AF50140-010	1,0	4	3,0	40	●	
AF50140-015	1,5	4	4,5	40	●	
AF50140-020	2,0	2	8,0	32	●	
AF50140-025	2,5	3	8,0	32	●	
AF50140-030	3,0	3	12,0	32	●	
AF50140-035	3,5	4	12,0	32	●	
AF50140-040	4,0	4	12,0	40	●	
AF50140-045	4,5	5	14,0	50	●	
AF50140-050	5,0	5	14,0	50	●	
AF50140-055	5,5	6	16,0	50	●	
AF50140-060	6,0	6	16,0	50	●	
AF50140-070	7,0	7	20,0	60	●	
AF50140-080	8,0	8	20,0	60	●	
AF50140-090	9,0	9	20,0	60	●	
AF50140-100	10,0	10	22,0	70	●	
AF50140-120	12,0	12	22,0	70	●	
AF50140-140	14,0	14	25,0	75	●	
AF50140-160	16,0	16	25,0	75	●	
AF50140-200	20,0	20	32,0	100	●	

P	●
M	●
K	●
N	
S	
H	

● Hauptanwendung  
Main application  
Application principale  
○ Nebenanwendung  
Secondary application  
Application secondaire

## AF50140-...R...

4 Schneiden, kurze Ausführung, mit Eckenradius / 4 flutes, short design, with corner radius / 4 dents, version courte avec rayon d'angle

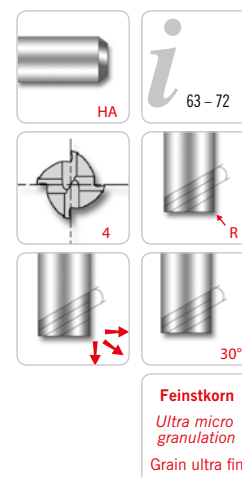
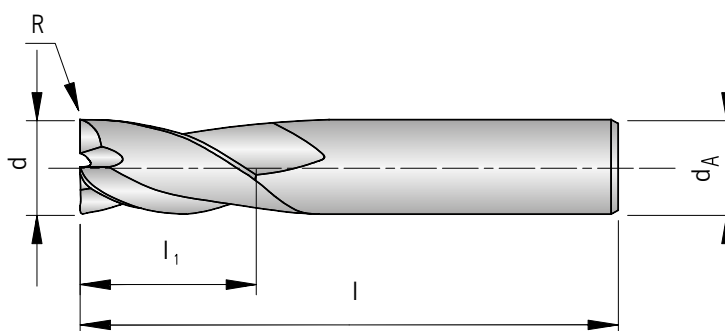

AF

							PG 24
							beschichtet coated revêtu
Schaft DIN 6535HA Shank Tige	d -0,03	d <sub>A</sub> h6	l <sub>1</sub>	l	R ± 0,03	TiAlN	
AF50140-020R0,2	2,0	4	4	50	0,2	●	
AF50140-020R0,3	2,0	4	4	50	0,3	●	
AF50140-020R0,5	2,0	4	4	50	0,5	●	
AF50140-025R0,2	2,5	4	5	50	0,2	●	
AF50140-025R0,3	2,5	4	5	50	0,3	●	
AF50140-025R0,5	2,5	4	5	50	0,5	●	
AF50140-030R0,2	3,0	4	6	50	0,2	●	
AF50140-030R0,3	3,0	4	6	50	0,3	●	
AF50140-030R0,5	3,0	4	6	50	0,5	●	
AF50140-030R1,0	3,0	4	6	50	1,0	●	
AF50140-040R0,2	4,0	4	8	50	0,2	●	
AF50140-040R0,3	4,0	4	8	50	0,3	●	
AF50140-040R0,5	4,0	4	8	50	0,5	●	
AF50140-040R1,0	4,0	4	8	50	1,0	●	
AF50140-050R0,2	5,0	6	10	50	0,2	●	
AF50140-050R0,3	5,0	6	10	50	0,3	●	
AF50140-050R0,5	5,0	6	10	50	0,5	●	
AF50140-050R1,0	5,0	6	10	50	1,0	●	
AF50140-060R0,2	6,0	6	12	50	0,2	●	
AF50140-060R0,3	6,0	6	12	50	0,3	●	
AF50140-060R0,5	6,0	6	12	50	0,5	●	
AF50140-060R1,0	6,0	6	12	50	1,0	●	
AF50140-080R0,5	8,0	8	16	60	0,5	●	
AF50140-080R1,0	8,0	8	16	60	1,0	●	
AF50140-080R1,5	8,0	8	16	60	1,5	●	
AF50140-080R2,0	8,0	8	16	60	2,0	●	
AF50140-080R2,5	8,0	8	16	60	2,5	●	
AF50140-100R0,5	10,0	10	20	75	0,5	●	
AF50140-100R1,0	10,0	10	20	75	1,0	●	
AF50140-100R1,5	10,0	10	20	75	1,5	●	
AF50140-100R2,0	10,0	10	20	75	2,0	●	
AF50140-100R2,5	10,0	10	20	75	2,5	●	

Solid carbide end-mill

Fraise carbure monobloc à tige

AF

							PG 24
							beschichtet coated revêtu
Schaft DIN 6535HA Shank Tige	d -0,03	d <sub>A</sub> h6	l <sub>1</sub>	l	R ± 0,03	TiAIN	
AF50140-120R0,5	12,0	12	24	75	0,5	●	
AF50140-120R1,0	12,0	12	24	75	1,0	●	
AF50140-120R1,5	12,0	12	24	75	1,5	●	
AF50140-120R2,0	12,0	12	24	75	2,0	●	
AF50140-120R2,5	12,0	12	24	75	2,5	●	

P	●
M	●
K	●
N	
S	
H	

- **Hauptanwendung**  
Main application  
Application principale
- **Nebenanwendung**  
Secondary application  
Application secondaire

Solid carbide end-mill  
Fraise carbure monobloc à tige

## AF60140-... X

4 Schneiden, kurze Ausführung / 4 flutes, short design / 4 dents, version courte

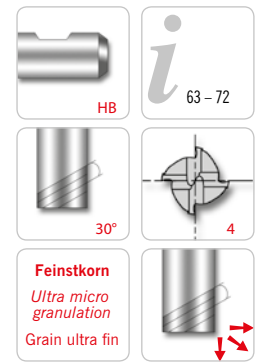
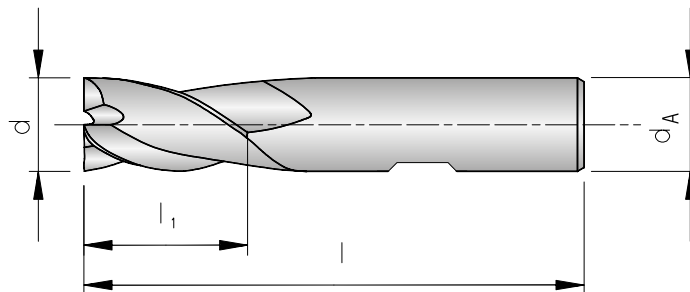

AF

						PG 24
						beschichtet coated revêtu
Schaft DIN 6535HB Shank Tige	d -0,03	d <sub>A</sub> h6	l <sub>1</sub>	l	TiAIN	
AF60140-020X	2,0	6	4	50	●	
AF60140-025X	2,5	6	4	50	●	
AF60140-030X	3,0	6	5	50	●	
AF60140-035X	3,5	6	6	50	●	
AF60140-040X	4,0	6	8	54	●	
AF60140-045X	4,5	6	8	54	●	
AF60140-050X	5,0	6	9	54	●	
AF60140-060X	6,0	6	10	54	●	
AF60140-070X	7,0	8	11	58	●	
AF60140-080X	8,0	8	12	58	●	
AF60140-090X	9,0	10	13	66	●	
AF60140-100X	10,0	10	14	66	●	
AF60140-120X	12,0	12	16	73	●	
AF60140-140X	14,0	14	18	75	●	
AF60140-160X	16,0	16	22	82	●	
AF60140-180X	18,0	18	24	84	●	
AF60140-200X	20,0	20	26	92	●	

P	●
M	●
K	●
N	
S	
H	

● Hauptanwendung  
Main application  
Application principale

○ Nebenanwendung  
Secondary application  
Application secondaire

## AF50141-... / AF60141\_...

4 Schneiden, lange Ausführung / 4 flutes, long design / 4 dents, version longue

AF

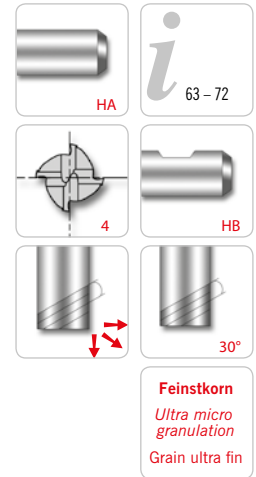
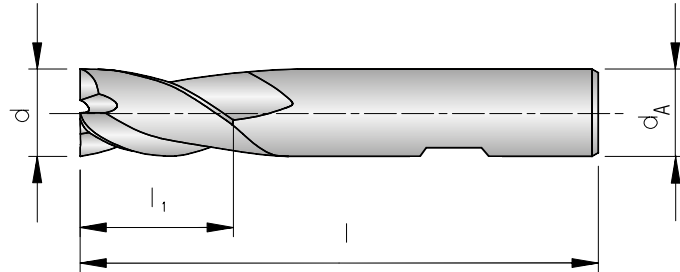

PG 24					
beschichtet coated revêtu					
Schaft DIN 6535HA Shank Tige	d -0,03	d <sub>A</sub> h6	l <sub>1</sub>	l	TiAlN
AF50141-020	2	3	7	38	●

Zylinderschaft nach DIN 6535HA ohne Mitnahmefläche

Cylindrical shank to DIN 6535HA, no flat

Queue cylindrique conforme à la norme DIN 6535HA sans surface d'entraînement

P	●
M	●
K	●
N	
S	
H	

● Hauptanwendung  
Main application  
Application principale

○ Nebenanwendung  
Secondary application  
Application secondaire

PG 24					
beschichtet coated revêtu					
Schaft DIN 6535HB	d	d <sub>A</sub>	l <sub>1</sub>	l	TiAlN
AF60141-030	3,0	6	8	57	●
AF60141-035	3,5	6	10	57	●
AF60141-040	4,0	6	11	57	●
AF60141-045	4,5	6	11	57	●
AF60141-050	5,0	6	13	57	●
AF60141-060	6,0	6	13	57	●
AF60141-070	7,0	8	16	63	●
AF60141-080	8,0	8	19	63	●
AF60141-090	9,0	10	19	72	●
AF60141-100	10,0	10	22	72	●
AF60141-120	12,0	12	26	83	●

						PG 24
						beschichtet coated revêtu
Schaft DIN 6535HB Shank Tige	d -0,03	d <sub>A</sub> h6	l <sub>1</sub>	l	TiAIN	
AF60141-140	14,0	14	26	83	●	
AF60141-160	16,0	16	32	92	●	
AF60141-180	18,0	18	32	92	●	
AF60141-200	20,0	20	38	104	●	

P	●
M	●
K	●
N	
S	
H	

- **Hauptanwendung**  
Main application  
Application principale
- **Nebenanwendung**  
Secondary application  
Application secondaire

Solid carbide end-mill

Fraise carbure monobloc à tige

## AF50141-...R...

4 Schneiden, lange Ausführung, mit Eckenradius / 4 flutes, long design, with corner radius / 4 dents, version longue, avec rayon d'angle

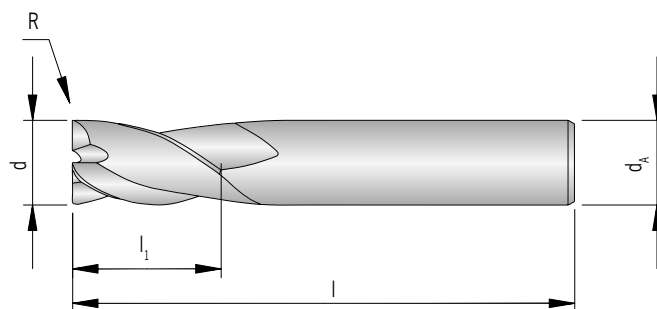
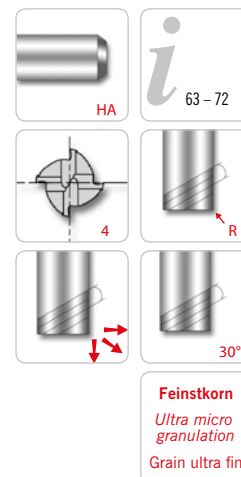

							PG 24
							beschichtet coated revêtu
Schaft DIN 6535HA Shank Tige	d -0,03	d <sub>A</sub> h6	l <sub>1</sub>	l	R ± 0,03	TiAIN	
AF50141-030R0,5	3	4	6	75	0,5	●	
AF50141-030R1,0	3	4	6	75	1,0	●	
AF50141-040R0,5	4	4	8	75	0,5	●	
AF50141-040R1,0	4	4	8	75	1,0	●	
AF50141-050R0,5	5	6	10	75	0,5	●	
AF50141-050R1,0	5	6	10	75	1,0	●	
AF50141-060R0,5	6	6	12	75	0,5	●	
AF50141-060R1,0	6	6	12	75	1,0	●	
AF50141-080R0,5	8	8	16	100	0,5	●	
AF50141-080R1,0	8	8	16	100	1,0	●	
AF50141-080R1,5	8	8	16	100	1,5	●	
AF50141-080R2,0	8	8	16	100	2,0	●	
AF50141-080R2,5	8	8	16	100	2,5	●	
AF50141-100R0,5	10	10	20	100	0,5	●	
AF50141-100R1,0	10	10	20	100	1,0	●	
AF50141-100R1,5	10	10	20	100	1,5	●	
AF50141-100R2,0	10	10	20	100	2,0	●	
AF50141-100R2,5	10	10	20	100	2,5	●	
AF50141-120R0,5	12	12	24	100	0,5	●	
AF50141-120R1,0	12	12	24	100	1,0	●	
AF50141-120R1,5	12	12	24	100	1,5	●	
AF50141-120R2,0	12	12	24	100	2,0	●	
AF50141-120R2,5	12	12	24	100	2,5	●	

● Hauptanwendung  
Main application  
Application principale  
○ Nebenanwendung  
Secondary application  
Application secondaire

P	●
M	●
K	●
N	
S	
H	



Solid carbide end-mill

Fraise carbure monobloc à tige

## AF50142-...X / AF60142-...X

4 Schneiden, extra lange Ausführung / 4 flutes, extra long design / 4 dents, version extra longue

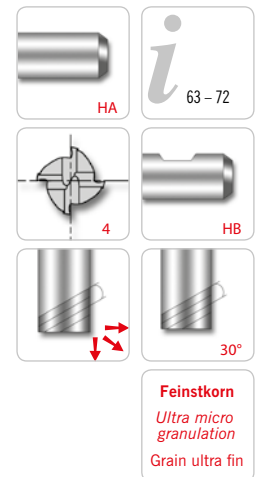
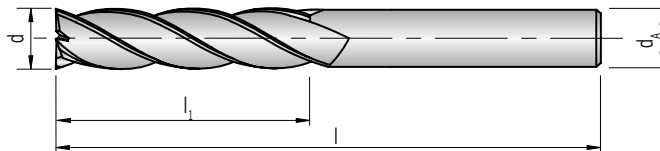

AF

					PG 24
					beschichtet coated revêtu
Schaft DIN 6535HA Shank Tige	d -0,03	d <sub>A</sub> h6	l <sub>1</sub>	l	TiN
AF50142-030X	3	3	20	60	●
AF50142-040X	4	4	20	60	●
AF50142-050X	5	5	25	75	●
AF50142-060X	6	6	30	75	●
AF50142-080X	8	8	30	75	●
AF50142-100X	10	10	40	100	●
AF50142-120X	12	12	45	100	●
AF50142-140X	14	14	45	100	●
AF50142-160X	16	16	45	100	●
AF50142-180X	18	18	45	100	●
AF50142-200X	20	20	45	100	●

Zylinderschaft nach DIN 6535HA ohne Mitnahmefläche

Cylindrical shank to DIN 6535HA, no flat

Queue cylindrique conforme à la norme DIN 6535HA sans surface d'entraînement

P	●
M	●
K	●
N	
S	
H	

● Hauptanwendung  
Main application  
Application principale  
○ Nebenanwendung  
Secondary application  
Application secondaire

					PG 24
					beschichtet coated revêtu
Schaft DIN 6535HB Shank Tige	d -0,03	d <sub>A</sub> h6	l <sub>1</sub>	l	TiAIN
AF60142-060X	6	6	30	75	●
AF60142-080X	8	8	30	75	●
AF60142-100X	10	10	40	100	●

P	●
M	●
K	●
N	
S	
H	

- **Hauptanwendung**  
Main application  
Application principale
- **Nebenanwendung**  
Secondary application  
Application secondaire

Solid carbide ball-nose end-mill  
Fraise carbure monobloc hémisphérique

## AF50340-...

4 Schneiden, kurze Ausführung / 4 flutes, short design / 4 dents, version courte

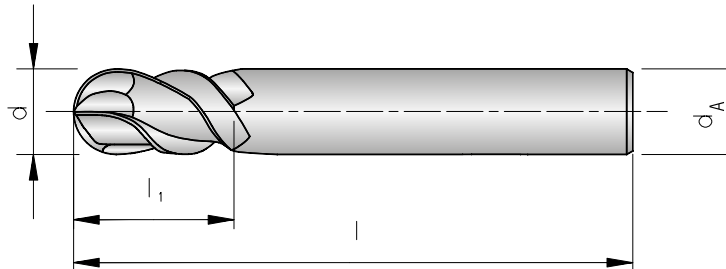

AF

							PG 24
							beschichtet coated revêtu
Schaft DIN 6535HA Shank Tige	d -0,03	d <sub>A</sub> h6	l <sub>1</sub>	l	R ± 0,02	TiAIN	
AF50340-020	2	6	4	48	1,0	●	
AF50340-030	3	6	4	48	1,5	●	
AF50340-040	4	6	6	50	2,0	●	
AF50340-050	5	6	7	51	2,5	●	
AF50340-060	6	6	7	51	3,0	●	
AF50340-080	8	8	9	59	4,0	●	
AF50340-100	10	10	10	60	5,0	●	
AF50340-120	12	12	14	71	6,0	●	
AF50340-140	14	14	14	71	7,0	●	
AF50340-160	16	16	16	76	8,0	●	
AF50340-180	18	18	18	76	9,0	●	
AF50340-200	20	20	20	82	10,0	●	

P	●
M	
K	●
N	
S	○
H	

● Hauptanwendung  
Main application  
Application principale  
○ Nebenanwendung  
Secondary application  
Application secondaire

Solid carbide end-mill

Fraise carbure monobloc à tige

AF

## AF502.0-...

4 - 6 Schneiden, kurze Ausführung / 4 - 6 flutes, short design / 4 - 6 dents, version courte

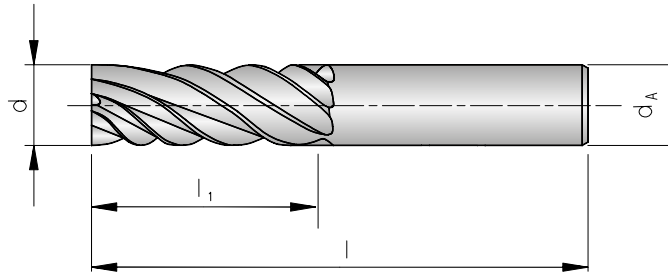

							PG 24
							beschichtet coated revêtu
Schaft DIN 6535HA Shank Tige	d -0,03	d <sub>A</sub> h6	l <sub>1</sub>	l	z	TiAIN	
AF50240-030	3	4	8	50	4	●	
AF50240-040	4	4	11	50	4	●	
AF50260-050	5	6	13	50	6	●	
AF50260-060	6	6	16	50	6	●	
AF50260-080	8	8	19	60	6	●	
AF50260-100	10	10	22	75	6	●	
AF50260-120	12	12	26	75	6	●	
AF50260-140	14	14	30	90	6	●	
AF50260-160	16	16	32	100	6	●	
AF50260-180	18	18	38	100	6	●	
AF50260-200	20	20	38	100	6	●	

P	●
M	●
K	●
N	
S	
H	

● **Hauptanwendung**  
Main application  
Application principale

○ **Nebenanwendung**  
Secondary application  
Application secondaire

Solid carbide end-mill  
Fraise carbure monobloc à tige

## AF50261-...

6 Schneiden, lange Ausführung / 6 flutes, long design / 6 dents, version longue

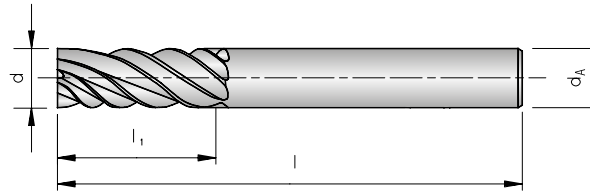

							PG 24
							beschichtet coated revêtu
Schaft DIN 6535HA Shank Tige	d -0,03	d <sub>A</sub> h6	l <sub>1</sub>	l	z	TiAIN	
AF50261-120	12	12	50	100	6	●	
AF50261-160	16	16	65	150	6	●	
AF50261-200	20	20	70	150	6	●	

P	●
M	●
K	●
N	
S	
H	

● **Hauptanwendung**  
Main application  
Application principale

○ **Nebenanwendung**  
Secondary application  
Application secondaire

Solid carbide roughing end-mill  
Fraise carbure monobloc d'ébauche

AF

## AF614.1-...

3 - 5 Schneiden, lange Ausführung / 3 - 5 flutes, long design / 3 - 5 dents, version longue

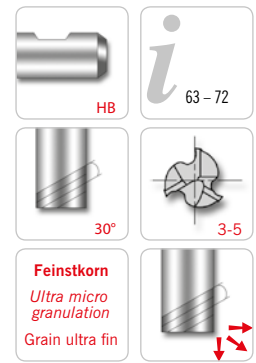
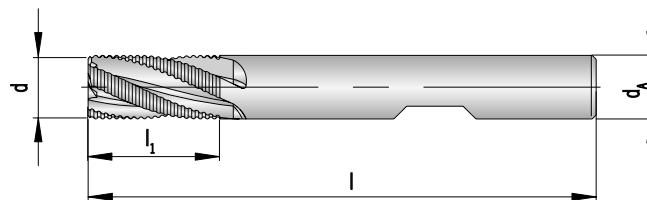

							PG 24
							beschichtet coated revêtu
Schaft DIN 6535HB Shank Tige	d h10	d <sub>A</sub> h6	l <sub>1</sub>	l	z	TiN	
AF61431-060	6	6	16	57	3	●	
AF61431-080	8	8	16	63	3	●	
AF61441-100	10	10	22	72	4	●	
AF61441-120	12	12	26	83	4	●	
AF61441-140	14	14	26	83	4	●	
AF61441-160	16	16	32	92	4	●	
AF61441-180	18	18	32	92	4	●	
AF61441-200	20	20	38	104	4	●	
AF61451-250	25	25	45	121	5	●	

P	●
M	●
K	●
N	
S	○
H	

● **Hauptanwendung**  
Main application  
Application principale

○ **Nebenanwendung**  
Secondary application  
Application secondaire

Werkstoffgruppe	Gliederung der Werkstoffhauptgruppen und Kennbuchstaben		Brinell-Härte	Zugfestigkeit Rm (N/mm <sup>2</sup> )	Zerspanungsgruppe	Korrekturfaktor	Schnittgeschwindigkeit V <sub>c</sub> (m/min)	
							VHM	TAIN
P	Unlegierter Stahl	C ≤ 0,25 % geglüht	125	428	P1	1,2	100 - 170 - 240	
		C > 0,25 ... ≤ 0,55 % geglüht	190	639	P2	1,2	100 - 170 - 240	
		C > 0,25 ... ≤ 0,55 % vergütet	210	708	P3	1,2	90 - 155 - 220	
		C > 0,55 % geglüht	190	639	P4	1,2	100 - 170 - 240	
		C > 0,55 % vergütet	300	1013	P5	1,0	60 - 100 - 140	
		Automatenstahl (kurzspanend) geglüht	220	745	P6	1,2	100 - 170 - 240	
	Niedrig legierter Stahl	geglüht	175	591	P7	1,2	90 - 145 - 200	
		vergütet	300	1013	P8	1,0	90 - 105 - 120	
		vergütet	380	1282	P9	0,8	60 - 90 - 120	
		vergütet	430	1477	P10	0,8	60 - 90 - 120	
	Hochlegierter Stahl und hochlegierter Werkzeugstahl	geglüht	200	675	P11	1,2	90 - 145 - 200	
		gehärtet und angelassen	300	1013	P12	1,0	90 - 115 - 140	
		gehärtet und angelassen	400	1361	P13	0,8	60 - 85 - 110	
	Nichtrostender Stahl	ferritisch / martensitisch, geglüht	200	675	P14	1,0	50 - 85 - 120	
		martensitisch, vergütet	330	1114	P15	0,9	30 - 55 - 80	
M	Nichtrostender Stahl	austenitisch, abgeschreckt	200	675	M1	1,0	60 - 90 - 120	
		austenitisch, ausscheidungsgehärtet (PH)	300	1013	M2	0,9	30 - 55 - 80	
		austenitisch-ferritisch, Duplex	230	778	M3	1,0	50 - 85 - 120	
K	Temperguss	ferritisch	200	675	K1	1,0	80 - 120 - 160	
		perritisch	260	867	K2	0,8	70 - 110 - 150	
	Grauguss	niedrige Festigkeit	180	602	K3	1,0	80 - 120 - 160	
		hohe Festigkeit / austenitisch	245	825	K4	1,0	70 - 110 - 150	
	Gusseisen mit Kugelgraphit	ferritisch	155	518	K5	1,0	80 - 120 - 160	
		perritisch	265	885	K6	1,0	70 - 110 - 150	
	GGV (CGI)		200	675	K7	1,0	80 - 120 - 160	
N	Aluminium-Knetlegierungen	nicht aushärtbar	30	-	N1		-	
		aushärtbar, ausgehärtet	100	343	N2		-	
	Aluminium-Gusslegierungen	≤ 12 % Si, nicht aushärtbar	75	260	N3		-	
		≤ 12 % Si, aushärtbar, ausgehärtet	90	314	N4		-	
		> 12 % Si, nicht aushärtbar	130	447	N5		-	
	Magnesiumlegierungen		70	250	N6		-	
	Kupfer und Kupferlegierungen (Bronze / Messing)	unlegiert, Elektrolytkupfer	100	343	N7		-	
		Messing, Bronze, Rotguss	90	314	N8		-	
		Cu-Legierung, kurzspanend	110	382	N9		-	
		hochfest, Ampco	300	1013	N10		-	
	Nichtmetallische Werkstoffe	Thermoplaste (ohne abrasive Füllstoffe)	-	-	N11		-	
		Duroplaste (ohne abrasive Füllstoffe)	-	-	N12		-	
		Kunststoff glasfaserverstärkt GFRP	-	-	N13		-	
		Kunststoff kohlefaserverstärkt CFRP	-	-	N14		-	
		Kunststoff aramidfaserverstärkt AFRP	-	-	N15		-	
		Graphit (technisch)	80 Shore	-	N16		-	
S	Warmfeste Legierungen	Fe-Basis geglüht	200	675	S1		-	
		ausgehärtet	280	943	S2		-	
		geglüht	250	839	S3		-	
		Ni- oder Co-Basis ausgehärtet	350	1177	S4		-	
		gegossen	320	1076	S5		-	
	Titanlegierungen	Reintitan	200	675	S6		-	
		α- und β-Legierungen, ausgehärtet	375	1262	S7		-	
		β-Legierungen	410	1396	S8		-	
	Wolframlegierungen		300	1013	S9		-	
	Molybdänlegierungen		300	1013	S10		-	
H	Gehärteter Stahl	gehärtet und angelassen	50 HRC	-	H1		-	
		gehärtet und angelassen	55 HRC	-	H2		-	
		gehärtet und angelassen	60 HRC	-	H3		-	
	Gehärtetes Gusseisen	gehärtet und angelassen	55 HRC	-	H4		-	

Die Tabellenwerte sind Richtwerte. Es kann notwendig sein, die Werte den jeweiligen Bearbeitungsumständen anzupassen.

Material group	Structure of the material groups and identification letters		Brinell hardness HB	Tensile strength Rm (N/mm <sup>2</sup> )	Chipping group	Correction factor	Cutting speed V <sub>c</sub> (m/min)	
							VHM	TAIN
P	Unalloyed steel	C ≤ 0.25 % annealed	125	428	P1	1,2	100 - 170 - 240	
		C > 0.25 ... ≤ 0.55 % annealed	190	639	P2	1,2	100 - 170 - 240	
		C > 0.25 ... ≤ 0.55 % hardened and tempered	210	708	P3	1,2	90 - 155 - 220	
		C > 0.55 % annealed	190	639	P4	1,2	100 - 170 - 240	
		C > 0.55 % hardened and tempered	300	1013	P5	1,0	60 - 100 - 140	
		Machining steel (short-chipping) tempered	220	745	P6	1,2	100 - 170 - 240	
	Low alloyed steel	annealed	175	591	P7	1,2	90 - 145 - 200	
		hardened and tempered	300	1013	P8	1,0	90 - 105 - 120	
		hardened and tempered	380	1282	P9	0,8	60 - 90 - 120	
		hardened and tempered	430	1477	P10	0,8	60 - 90 - 120	
	High alloyed steel and high alloyed tool steel	annealed	200	675	P11	1,2	90 - 145 - 200	
		hardened	300	1013	P12	1,0	90 - 115 - 140	
		hardened	400	1361	P13	0,8	60 - 85 - 110	
	Stainless steel	ferritic / martensitic, annealed	200	675	P14	1,0	50 - 85 - 120	
		martensitic, hardened and tempered	330	1114	P15	0,9	30 - 55 - 80	
M	Stainless steel	austenitic, chilled	200	675	M1	1,0	60 - 90 - 120	
		austenitic, precipitation-hardened (PH)	300	1013	M2	0,9	30 - 55 - 80	
		austenitic-ferritic, Duplex	230	778	M3	1,0	50 - 85 - 120	
K	Malleable cast iron	ferritic	200	675	K1	1,0	80 - 120 - 160	
		pearlitic	260	867	K2	0,8	70 - 110 - 150	
	Cast iron	low tensile strength	180	602	K3	1,0	80 - 120 - 160	
		high tensile strength / austenitic	245	825	K4	1,0	70 - 110 - 150	
	Cast iron with nodular graphite	ferritic	155	518	K5	1,0	80 - 120 - 160	
		pearlitic	265	885	K6	1,0	70 - 110 - 150	
	GGV (CGI)		200	675	K7	1,0	80 - 120 - 160	
N	Aluminium alloys long chipping	not heat treatable	30	-	N1		-	
		heat treatable, heat treated	100	343	N2		-	
	Casted aluminium alloys	≤ 12 % Si, not heat treatable	75	260	N3		-	
		≤ 12 % Si, aushärtbar, ausgehärtet	90	314	N4		-	
		> 12 % Si, not heat treatable	130	447	N5		-	
	Magnesium alloys		70	250	N6		-	
	Copper and copper alloys (Brass / Bronze)	Unalloyed, elektrolyte copper	100	343	N7		-	
		Brass, Bronze	90	314	N8		-	
		Cu-alloys, short-chipping	110	382	N9		-	
		High-tensile, Ampco	300	1013	N10		-	
	Non-ferrous materials	Lead alloys (without abrasive filling material)	-	-	N11		-	
		Duroplastic (without abrasive filling material)	-	-	N12		-	
		Plastic glas fibre reinforced GFRP	-	-	N13		-	
		Plastic carbon fibre reinforced CFRP	-	-	N14		-	
		Plastic aramid fibre reinforced AFRP	-	-	N15		-	
		Graphite (tech.)	80 Shore	-	N16		-	
S	High temperature resistant alloys	Fe-Basis	annealed	200	675	S1		-
			heat treated	280	943	S2		-
		Ni- or Co-alloyed	annealed	250	839	S3		-
			heat treated	350	1177	S4		-
			casting	320	1076	S5		-
	Titanium alloys	Pure titan	200	675	S6		-	
		α- and β-alloys, heat treated	375	1262	S7		-	
	β-alloys	410	1396	S8		-		
	Wolfram alloys		300	1013	S9		-	
	Molybdän alloys		300	1013	S10		-	
H	Hardened steel	hardened	50 HRC	-	H1		-	
		hardened	55 HRC	-	H2		-	
		hardened	60 HRC	-	H3		-	
	Hardened cast iron	hardened	55 HRC	-	H4		-	

The recommended cutting data are only approximate values. It may be necessary to adjust them to each individual machining application.



ISO	Matériaux	Dureté Brinell	Résistance (N/mm <sup>2</sup> )	Groupe d'usinage	facteur de correction	Vitesse de coupe Vc (m/min)	
						VHM	TAIN
P	Acier non allié	C ≤ 0,25 % recuit	125	428	P1	1,2	100 - 170 - 240
		C > 0,25 ... ≤ 0,55 % recuit	190	639	P2	1,2	100 - 170 - 240
		C > 0,25 ... ≤ 0,55 % traité	210	708	P3	1,2	90 - 155 - 220
		C > 0,55 % recuit	190	639	P4	1,2	100 - 170 - 240
		C > 0,55 % traité	300	1013	P5	1,0	60 - 100 - 140
		Aciers de décolletage (à copeaux courts) recuit	220	745	P6	1,2	100 - 170 - 240
	Acier faiblement allié	recuit	175	591	P7	1,2	90 - 145 - 200
		traité	300	1013	P8	1,0	90 - 105 - 120
		traité	380	1282	P9	0,8	60 - 90 - 120
		traité	430	1477	P10	0,8	60 - 90 - 120
	Acier allié et acier outil allié	recuit	200	675	P11	1,2	90 - 145 - 200
		trempe et revenu	300	1013	P12	1,0	90 - 115 - 140
		trempe et revenu	400	1361	P13	0,8	60 - 85 - 110
	Acier inox	ferritique, martensitique, recuit	200	675	P14	1,0	50 - 85 - 120
		martensitique, traité	330	1114	P15	0,9	30 - 55 - 80
M	Acier inox	austénitique	200	675	M1	1,0	60 - 90 - 120
		austénitique	300	1013	M2	0,9	30 - 55 - 80
		austénitique-ferritique, Duplex	230	778	M3	1,0	50 - 85 - 120
K	Fonte malléable	ferritique	200	675	K1	1,0	80 - 120 - 160
		perlitique	260	867	K2	0,8	70 - 110 - 150
	Fonte grise	faible résistance	180	602	K3	1,0	80 - 120 - 160
		haute résistance / austénitique	245	825	K4	1,0	70 - 110 - 150
	Fonte à Graphite sphéroïdale	ferritique	155	518	K5	1,0	80 - 120 - 160
		perlitique	265	885	K6	1,0	70 - 110 - 150
GGV (CGI)		200	675	K7	1,0	80 - 120 - 160	
N	Alliages de fonderie d'aluminium	ne pouvant pas subir un durcissement	30	-	N1		-
		pouvant subir un durcissement, durci	100	343	N2		-
		≤ 12 % Si, ne pouvant pas subir de durcissement	75	260	N3		-
	Alliage de fonte d'aluminium	≤ 12 % Si, pouvant subir un durcissement, durci	90	314	N4		-
		> 12 % Si, ne pouvant pas subir de durcissement	130	447	N5		-
	Alliage de Magnésium		70	250	N6		-
	Cuivre et alliage de cuivre (bronze / laiton)	non allié, cuivre électrolytique	100	343	N7		-
		Laiton, bronze, fonte rouge	90	314	N8		-
		Alliage de cuivre à copeaux courts	110	382	N9		-
		forte résistance, Ampco	300	1013	N10		-
Matériaux non métalliques	Thermoplaste (sans agents de charge abrasives)	-	-	N11		-	
	Duroplaste (sans agents de charge abrasives)	-	-	N12		-	
	Matière plastique renforcée de fibres de verre GFRP	-	-	N13		-	
	Matière plastique renforcé composite CFRP	-	-	N14		-	
	Plastique renforcé fibre aramide AFRP	-	-	N15		-	
	Graphite	80 Shore	-	N16		-	
S	Alliages réfractaires	à base de Fe recuit	200	675	S1		-
		à base de Fe durci	280	943	S2		-
		à base de Fe recuit	250	839	S3		-
		à base Ni ou Co durci	350	1177	S4		-
		à base Ni ou Co jeter	320	1076	S5		-
	Alliage de titane	Titane pur	200	675	S6		-
		Alliages Alpha + Beta, trempé	375	1262	S7		-
		Alliages Beta	410	1396	S8		-
	Alliage de tungstène		300	1013	S9		-
	Alliage de molybdène		300	1013	S10		-
H	Acier trempé	trempe et revenu	50 HRC	-	H1		-
		trempe et revenu	55 HRC	-	H2		-
		trempe et revenu	60 HRC	-	H3		-
	Fonte durci	trempe et revenu	55 HRC	-	H4		-

Les valeurs du tableau sont indicatives. Il peut être nécessaire de les adapter aux conditions d'usinage respectives.

## Weitere Highlights unserer Frässysteme.

*Other highlights from our milling range.*

*Autres points forts de notre gamme de fraisage.*



### **ARNO®-Frässystem DUO-MILL**

**Eckfräsen und HFC-Fräsen mit nur einem Werkzeug.**

*ARNO® milling-system DUO-MILL*

*Square shoulder and high feed (HFC) milling with just one tool.*

*Système de fraisage ARNO® DUO-MILL*

*Fraisage à 90° et grande avance avec un seul outil*



### **ARNO®-Frässystem FTA**

**Der universelle Planfräser zur Kostenreduzierung.**

*ARNO® milling-system FTA*

*Face milling tool for cost reduction.*

*Système de fraisage ARNO® FTA*

*Le surfacage rentable !*



### **ARNO®-Frässystem FOA**

**Der positiv weichschneidende Planfräser, der eine Rundplatte und eine oktagonale Wendschneidplatte in einem Plattensitz vereint.**

*ARNO® milling-system FOA*

*The positive face-milling-cutter, in which both a round and an octogonal insert can be used.*

*Système de fraisage ARNO® FOA*

*La fraise polyvalente qui peut recevoir des plaquettes octogonales ou rondes, angle d'attaque positif pour une coupe douce et des efforts de coupe réduits au minimum.*

**ARNO®**  
**WERKZEUGE**

**Weitere Informationen finden Sie unter**

*For more information see*

*Pour plus d'informations*

**www.arno.de**

Für die nachfolgenden Vorschub-Richtwerte müssen die Werte je nach zu bearbeitendem Material gemäß dem in den Schnittgeschwindigkeitstabellen angegebenen Korrekturfaktor korrigiert werden.

For the following feed tables the values must be corrected depending on the material being machined in line with the correction factor.

Pour les valeurs d'avance (indicatives) suivantes, les valeurs doivent être rectifiées en fonction du matériau à usiner selon le facteur de correction indiqué dans les tableaux des vitesses de coupe.

**Beispiel für Fräser mit Schneidendurchmesser 6 mm:**

An example using a cutter with  $\varnothing$  6 mm is detailed:

Exemple pour une fraise avec un diamètre de coupe de 6 mm :

**Schnittgeschwindigkeits-Tabelle /  $V_c$ -table / Tableau des vitesses de coupe**

ISO	Werkstoff / Material / Matériau	Festigkeit Strength Résistance [N/mm <sup>2</sup> - HB]	Kf [x $f_z$ ]	TiAlN $V_c$ [m/min]
P	<b>Allgemeiner Baustahl</b> General construction steel Acier de construction en général	< 800 N/mm <sup>2</sup>	1,2	100 - 150
	<b>Automatenstahl</b> Free cutting steel Acier de décolletage	< 800 N/mm <sup>2</sup>	1,2	100 - 150
	<b>Einsatzstahl, unlegiert</b> Case hardened steel, non alloyed Acier cémenté, non allié	< 800 N/mm <sup>2</sup>	1,2	100 - 150
	<b>Einsatzstahl, legiert</b> Alloyed case hardened steel Acier cémenté, allié	< 1000 N/mm <sup>2</sup>	1	90 - 120
	<b>Vergütungsstahl, unlegiert</b> Tempering steel, non alloyed Acier de traitement, non allié	< 850 N/mm <sup>2</sup>	1,2	90 - 130
	<b>Vergütungsstahl, unlegiert</b> Tempering steel, non alloyed Acier de traitement, non allié	< 1000 N/mm <sup>2</sup>	1	60 - 90
	<b>Vergütungsstahl, legiert</b> Tempering steel, alloyed Acier de traitement, allié	< 800 N/mm <sup>2</sup>	1,2	90 - 120
	<b>Vergütungsstahl, legiert</b> Tempering steel, alloyed Acier de traitement, allié	< 1300 N/mm <sup>2</sup>	0,8	60 - 80
	<b>Stahlguss</b> Steel castings Acier coulé	< 850 N/mm <sup>2</sup>	1,2	70 - 100

**Korrekturfaktor-Tabelle /  $f_z$ -table / Tableau des facteurs de correction**

$\varnothing$ $d_1$ [mm]	Korrekturfaktor / Correction factor / Facteur de correction		
	1	0,7	0,8
1	0,004	0,003	0,003
2	0,008	0,006	0,006
3	0,012	0,008	0,010
4	0,016	0,011	0,013
5	0,020	0,014	0,016
6	0,024	0,017	0,019
8	0,032	0,022	0,026

Für legierten Einsatzstahl gilt der Vorschubwert aus der Korrekturfaktor-Tabelle.  $K_f(f_z) = 1$  (entsprechend 100%)  $f_z = 0,024$

Für legierten Vergütungsstahl < 1300 N/mm<sup>2</sup> wird der Vorschubwert aus der Korrekturfaktor-Tabelle um 20% reduziert.

$K_f(f_z) = 0,8$  (entsprechend 80%)  $f_z = 0,019$

For case-hardening alloy steel the feed value from the table is valid:  $K_f(f_z) = 1$  (according to 100%)  $f_z = 0,024$

For heat treatable steel alloys < 1300 N/mm<sup>2</sup> the feed value from the table is reduced by 20%.

$K_f(f_z) = 0,8$  (according to 80%)  $f_z = 0,019$

La valeur d'avance du tableau des facteurs de correction est valable pour l'acier cémenté allié.

$K_f(f_z) = 1$  (correspondant à 100 %)  $f_z = 0,024$

La valeur d'avance du tableau des facteurs de correction est réduite de 20 % pour l'acier de traitement allié < 1 300 N/mm<sup>2</sup>.

$K_f(f_z) = 0,8$  (correspondant à 80 %)  $f_z = 0,019$

**Generelle Berechnungsformeln / General rule: / Formules de calcul générales :**

**Vorschub pro Zahn / Feed per tooth: / Avance par dent :** =  $f_z \cdot K_f(f_z)$

**Bohrvorschub (Fräsen in axialer Richtung):** = Tabellenwert / Zähnezahl

For axial plunge milling: = Table value / Number of teeth

Avance de perçage (fraisage dans le sens axial) : = valeur du tableau / nombre de dents

## Vorschub pro Zahn bei einer radialen Zustellung von 0,2 – 0,3 mm

Feed per tooth with radial depth of cut from 0,2 – 0,3 mm

Avance par dent avec une disposition radiale de 0,2 – 0,3 mm

Ø d <sub>1</sub> [mm]	Korrekturfaktor / Correction factor / Facteur de correction									
	1	0,7	0,8	0,9	1,1	1,2	1,5	1,6	1,8	1,9
1	0,004	0,003	0,003	0,004	0,004	0,005	0,006	0,006	0,007	0,008
2	0,008	0,006	0,006	0,007	0,009	0,010	0,012	0,013	0,014	0,015
3	0,012	0,008	0,010	0,011	0,013	0,014	0,018	0,019	0,022	0,023
4	0,016	0,011	0,013	0,014	0,018	0,019	0,024	0,026	0,029	0,030
5	0,020	0,014	0,016	0,018	0,022	0,024	0,030	0,032	0,036	0,038
6	0,024	0,017	0,019	0,022	0,026	0,029	0,036	0,038	0,043	0,046
8	0,032	0,022	0,026	0,029	0,035	0,038	0,048	0,051	0,058	0,061
10	0,040	0,028	0,032	0,036	0,044	0,048	0,060	0,064	0,072	0,076
12	0,048	0,034	0,038	0,043	0,053	0,058	0,072	0,077	0,086	0,091
14	0,056	0,039	0,045	0,050	0,062	0,067	0,084	0,090	0,101	0,106
16	0,064	0,045	0,051	0,058	0,070	0,077	0,096	0,102	0,115	0,122
18	0,072	0,050	0,058	0,065	0,079	0,086	0,108	0,115	0,130	0,137
20	0,080	0,056	0,064	0,072	0,088	0,096	0,120	0,128	0,144	0,152
25	0,100	0,070	0,080	0,090	0,110	0,120	0,150	0,160	0,180	0,190

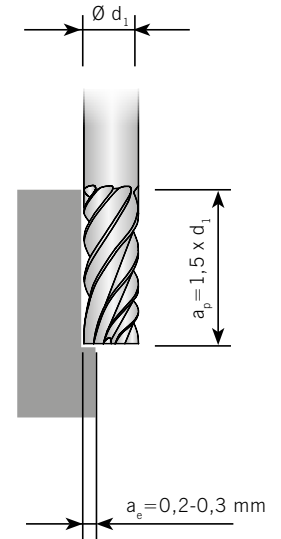

## Vorschub pro Zahn bei einer radialen Zustellung 10% vom Schneidendurchmesser (Ø d<sub>1</sub>)

Feed per tooth with radial depth of cut of 10% of the cutter (Ø d<sub>1</sub>)

Avance par dent avec une disposition radiale de 10 % du diamètre de coupe (Ø d<sub>1</sub>)

Ø d <sub>1</sub> [mm]	Korrekturfaktor / Correction factor / Facteur de correction									
	1	0,7	0,8	0,9	1,1	1,2	1,5	1,6	1,8	1,9
1	0,003	0,002	0,002	0,003	0,003	0,004	0,005	0,005	0,005	0,006
2	0,008	0,006	0,006	0,007	0,009	0,010	0,012	0,013	0,014	0,015
3	0,012	0,008	0,010	0,011	0,013	0,014	0,018	0,019	0,022	0,023
4	0,014	0,010	0,011	0,013	0,015	0,017	0,021	0,022	0,025	0,027
5	0,017	0,012	0,014	0,015	0,019	0,020	0,026	0,027	0,031	0,032
6	0,020	0,014	0,016	0,018	0,022	0,024	0,030	0,032	0,036	0,038
8	0,027	0,019	0,022	0,024	0,030	0,032	0,041	0,043	0,049	0,051
10	0,033	0,023	0,026	0,030	0,036	0,040	0,050	0,053	0,059	0,063
12	0,040	0,028	0,032	0,036	0,044	0,048	0,060	0,064	0,072	0,076
14	0,047	0,033	0,038	0,042	0,052	0,056	0,071	0,075	0,085	0,089
16	0,053	0,037	0,042	0,048	0,058	0,064	0,080	0,085	0,095	0,101
18	0,060	0,042	0,048	0,054	0,066	0,072	0,090	0,096	0,108	0,114
20	0,067	0,047	0,054	0,060	0,074	0,080	0,101	0,107	0,121	0,127
25	0,083	0,058	0,066	0,075	0,091	0,100	0,125	0,133	0,149	0,158

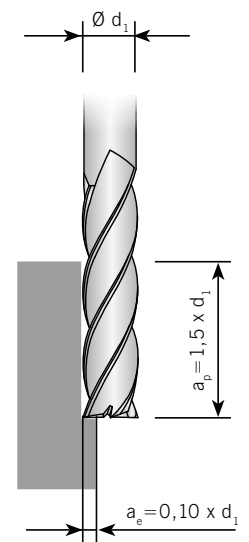

**Achtung:** Korrekturfaktor aus der Tabelle "Schnittgeschwindigkeiten" entnehmen.  
Korrekturfaktor -> 1,1 bei a<sub>p</sub> = 1 x d<sub>1</sub> -> 1,2 bei a<sub>p</sub> = 0,5 x d<sub>1</sub>

Attention: Take the correction factor from the table "Cutting speeds".  
Correction factor -> 1,1 with a<sub>p</sub> = 1 x d<sub>1</sub> -> 1,2 with a<sub>p</sub> = 0,5 x d<sub>1</sub>

Attention: Prenez le facteur de correction du tableau «Vitesse de coupe».  
Facteur de correction -> 1,1 pour a<sub>p</sub> = 1 x d<sub>1</sub> -> 1,2 pour a<sub>p</sub> = 0,5 x d<sub>1</sub>

**Vorschub pro Zahn bei einer radialen Zustellung 20% vom Schneidendurchmesser ( $\varnothing d_1$ )**

Feed per tooth with radial depth of cut of 20% of the cutter ( $\varnothing d_1$ )

Avance par dent avec une disposition radiale de 20% du diamètre de coupe ( $\varnothing d_1$ )

$\varnothing d_1$ [mm]	Korrekturfaktor / Correction factor / Facteur de correction									
	1	0,7	0,8	0,9	1,1	1,2	1,5	1,6	1,8	1,9
1	0,002	0,001	0,001	0,001	0,002	0,002	0,003	0,003	0,003	0,003
2	0,005	0,003	0,004	0,004	0,005	0,006	0,007	0,008	0,009	0,009
3	0,008	0,005	0,006	0,007	0,008	0,009	0,012	0,012	0,014	0,015
4	0,010	0,007	0,008	0,009	0,011	0,012	0,015	0,016	0,018	0,019
5	0,013	0,009	0,010	0,011	0,014	0,015	0,019	0,020	0,023	0,024
6	0,015	0,010	0,012	0,013	0,016	0,018	0,022	0,024	0,027	0,028
8	0,020	0,014	0,016	0,018	0,022	0,024	0,030	0,032	0,036	0,038
10	0,025	0,017	0,020	0,022	0,027	0,030	0,037	0,040	0,045	0,047
12	0,030	0,021	0,024	0,027	0,033	0,036	0,045	0,048	0,054	0,057
14	0,035	0,024	0,028	0,031	0,038	0,042	0,052	0,056	0,063	0,066
16	0,040	0,028	0,032	0,036	0,044	0,048	0,060	0,064	0,072	0,076
18	0,045	0,031	0,036	0,040	0,049	0,054	0,067	0,072	0,081	0,085
20	0,050	0,035	0,040	0,045	0,055	0,060	0,075	0,080	0,090	0,095
25	0,063	0,044	0,050	0,056	0,069	0,075	0,094	0,100	0,113	0,119

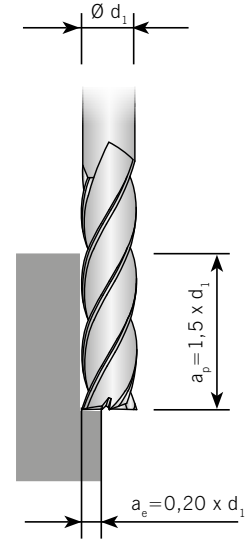

**Vorschub pro Zahn bei einer radialen Zustellung 40% vom Schneidendurchmesser ( $\varnothing d_1$ )**

Feed per tooth with radial depth of cut of 40% of the cutter ( $\varnothing d_1$ )

Avance par dent avec une disposition radiale de 40% du diamètre de coupe ( $\varnothing d_1$ )

$\varnothing d_1$ [mm]	Korrekturfaktor / Correction factor / Facteur de correction									
	1	0,7	0,8	0,9	1,1	1,2	1,5	1,6	1,8	1,9
1	0,001	0,001	0,001	0,001	0,001	0,001	0,002	0,002	0,002	0,003
2	0,004	0,002	0,003	0,003	0,004	0,004	0,006	0,006	0,007	0,007
3	0,006	0,004	0,005	0,005	0,007	0,007	0,009	0,010	0,011	0,012
4	0,008	0,005	0,006	0,007	0,008	0,009	0,012	0,012	0,014	0,015
5	0,010	0,007	0,008	0,009	0,011	0,012	0,015	0,016	0,018	0,019
6	0,012	0,008	0,009	0,010	0,013	0,014	0,018	0,019	0,021	0,022
8	0,016	0,011	0,012	0,014	0,017	0,019	0,024	0,025	0,028	0,030
10	0,020	0,014	0,016	0,018	0,022	0,024	0,030	0,032	0,036	0,038
12	0,024	0,016	0,019	0,021	0,026	0,028	0,036	0,038	0,043	0,045
14	0,028	0,019	0,022	0,025	0,030	0,033	0,042	0,044	0,050	0,053
16	0,032	0,022	0,025	0,028	0,035	0,038	0,048	0,051	0,057	0,060
18	0,036	0,025	0,028	0,032	0,039	0,043	0,054	0,057	0,064	0,068
20	0,040	0,028	0,032	0,036	0,044	0,048	0,060	0,064	0,072	0,076
25	0,050	0,035	0,040	0,045	0,055	0,060	0,075	0,080	0,090	0,095

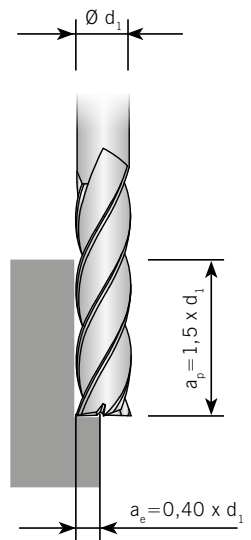

Achtung: Korrekturfaktor aus der Tabelle "Schnittgeschwindigkeiten" entnehmen.  
Korrekturfaktor -> 1,1 bei  $a_p = 1 \times d_1$  -> 1,2 bei  $a_p = 0,5 \times d_1$

Attention: Take the correction factor from the table "Cutting speeds".  
Correction factor -> 1,1 with  $a_p = 1 \times d_1$  -> 1,2 with  $a_p = 0,5 \times d_1$

Attention: Prenez le facteur de correction du tableau «Vitesse de coupe».  
Facteur de correction -> 1,1 pour  $a_p = 1 \times d_1$  -> 1,2 pour  $a_p = 0,5 \times d_1$



**Vorschub pro Zahn bei einer radialen Zustellung 60% vom Schneidendurchmesser ( $\varnothing d_1$ )**

Feed per tooth with radial depth of cut of 60% of the cutter ( $\varnothing d_1$ )

Avance par dent avec une disposition radiale de 60% du diamètre de coupe ( $\varnothing d_1$ )

$\varnothing d_1$ [mm]	Korrekturfaktor / Correction factor / Facteur de correction									
	1	0,7	0,8	0,9	1,1	1,2	1,5	1,6	1,8	1,9
1	0,001	0,001	0,001	0,001	0,001	0,001	0,001	0,002	0,002	0,002
2	0,003	0,002	0,002	0,002	0,003	0,003	0,004	0,005	0,005	0,006
3	0,005	0,003	0,004	0,004	0,005	0,006	0,007	0,008	0,009	0,009
4	0,006	0,004	0,005	0,005	0,007	0,007	0,009	0,010	0,011	0,012
5	0,008	0,005	0,006	0,007	0,009	0,010	0,012	0,013	0,015	0,016
6	0,009	0,006	0,007	0,008	0,010	0,011	0,014	0,015	0,017	0,018
8	0,013	0,009	0,010	0,011	0,014	0,015	0,019	0,020	0,023	0,024
10	0,016	0,011	0,013	0,014	0,017	0,019	0,024	0,026	0,029	0,030
12	0,019	0,013	0,015	0,017	0,021	0,023	0,029	0,031	0,035	0,037
14	0,022	0,015	0,018	0,020	0,025	0,027	0,034	0,036	0,040	0,043
16	0,026	0,018	0,020	0,023	0,028	0,031	0,039	0,041	0,046	0,049
18	0,029	0,020	0,023	0,026	0,032	0,035	0,043	0,046	0,052	0,055
20	0,032	0,022	0,026	0,029	0,035	0,039	0,048	0,052	0,058	0,061
25	0,040	0,028	0,032	0,036	0,045	0,049	0,061	0,065	0,073	0,077

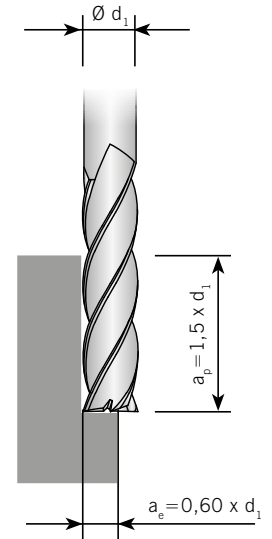

**Vorschub pro Zahn bei einer radialen Zustellung 80% vom Schneidendurchmesser ( $\varnothing d_1$ )**

Feed per tooth with radial depth of cut of 80% of the cutter ( $\varnothing d_1$ )

Avance par dent avec une disposition radiale de 80% du diamètre de coupe ( $\varnothing d_1$ )

$\varnothing d_1$ [mm]	Korrekturfaktor / Correction factor / Facteur de correction									
	1	0,7	0,8	0,9	1,1	1,2	1,5	1,6	1,8	1,9
1	0,001	0,001	0,001	0,001	0,001	0,001	0,001	0,001	0,001	0,001
2	0,002	0,001	0,002	0,002	0,002	0,003	0,003	0,004	0,004	0,004
3	0,004	0,002	0,003	0,003	0,004	0,004	0,006	0,006	0,007	0,007
4	0,005	0,003	0,004	0,004	0,005	0,006	0,007	0,008	0,009	0,009
5	0,006	0,004	0,005	0,005	0,007	0,007	0,009	0,010	0,011	0,012
6	0,007	0,005	0,006	0,006	0,008	0,009	0,011	0,012	0,013	0,014
8	0,010	0,007	0,008	0,009	0,011	0,012	0,015	0,016	0,018	0,019
10	0,012	0,008	0,010	0,011	0,013	0,015	0,018	0,020	0,022	0,023
12	0,015	0,010	0,012	0,013	0,016	0,018	0,022	0,024	0,027	0,028
14	0,017	0,012	0,014	0,015	0,019	0,021	0,026	0,028	0,031	0,033
16	0,020	0,014	0,016	0,018	0,022	0,024	0,030	0,032	0,036	0,038
18	0,022	0,015	0,018	0,020	0,024	0,027	0,033	0,036	0,040	0,042
20	0,025	0,017	0,020	0,022	0,027	0,030	0,037	0,040	0,045	0,047
25	0,031	0,022	0,025	0,028	0,034	0,037	0,047	0,050	0,056	0,059

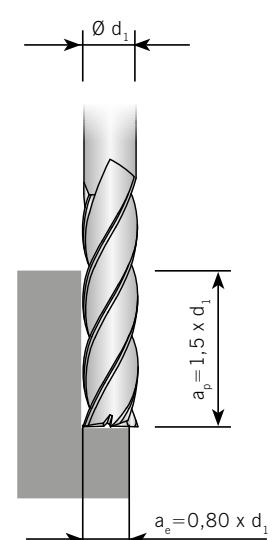

Achtung: Korrekturfaktor aus der Tabelle "Schnittgeschwindigkeiten" entnehmen.  
Korrekturfaktor -> 1,1 bei  $a_p = 1 \times d_1$  -> 1,2 bei  $a_p = 0,5 \times d_1$

Attention: Take the correction factor from the table "Cutting speeds".  
Correction factor -> 1,1 with  $a_p = 1 \times d_1$  -> 1,2 with  $a_p = 0,5 \times d_1$

Attention: Prenez le facteur de correction du tableau «Vitesses de coupe».  
Facteur de correction -> 1,1 pour  $a_p = 1 \times d_1$  -> 1,2 pour  $a_p = 0,5 \times d_1$

Recommended cutting data feed tables

Tableaux des avances valeurs de coupe recommandées

**Vorschub pro Zahn beim Vollnutfräsen →  $a_p = 0,5 \times d_1$**

Feed per tooth when full slot milling →  $a_p = 0,5 \times d_1$

Avance par dent pour le rainurage →  $a_p = 0,5 \times d_1$

Ø d <sub>1</sub> [mm]	Korrekturfaktor / Correction factor / Facteur de correction									
	1	0,7	0,8	0,9	1,1	1,2	1,5	1,6	1,8	1,9
1	0,002	0,001	0,001	0,001	0,002	0,002	0,003	0,003	0,003	0,003
2	0,004	0,002	0,003	0,003	0,004	0,004	0,006	0,006	0,007	0,007
3	0,007	0,004	0,005	0,006	0,007	0,008	0,010	0,011	0,012	0,013
4	0,009	0,006	0,007	0,008	0,009	0,010	0,013	0,014	0,016	0,017
5	0,011	0,007	0,008	0,009	0,012	0,013	0,016	0,017	0,019	0,020
6	0,013	0,009	0,010	0,011	0,014	0,015	0,019	0,020	0,023	0,024
8	0,018	0,012	0,014	0,016	0,019	0,021	0,027	0,028	0,032	0,034
10	0,022	0,015	0,017	0,019	0,024	0,026	0,033	0,035	0,039	0,041
12	0,030	0,021	0,024	0,027	0,033	0,036	0,045	0,048	0,054	0,057
14	0,032	0,022	0,025	0,028	0,035	0,038	0,048	0,051	0,057	0,060
16	0,036	0,025	0,028	0,032	0,039	0,043	0,054	0,057	0,064	0,068
18	0,042	0,029	0,033	0,037	0,046	0,050	0,063	0,067	0,075	0,079
20	0,045	0,031	0,036	0,040	0,049	0,054	0,067	0,072	0,081	0,085
25	0,056	0,039	0,044	0,050	0,061	0,067	0,084	0,089	0,100	0,106

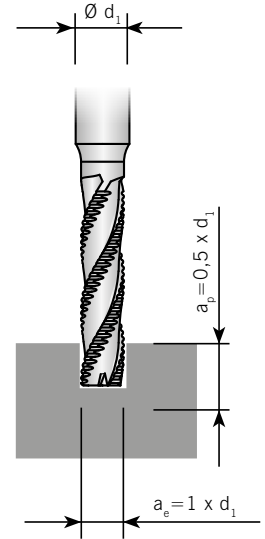

**Vorschub pro Zahn beim Vollnutfräsen →  $a_p = 1 \times d_1$**

Feed per tooth when full slot milling →  $a_p = 1 \times d_1$

Avance par dent pour le rainurage →  $a_p = 1 \times d_1$

Ø d <sub>1</sub> [mm]	Korrekturfaktor / Correction factor / Facteur de correction									
	1	0,7	0,8	0,9	1,1	1,2	1,5	1,6	1,8	1,9
1	0,001	0,001	0,001	0,001	0,001	0,002	0,002	0,002	0,002	0,002
2	0,003	0,002	0,002	0,002	0,003	0,003	0,004	0,004	0,005	0,005
3	0,005	0,003	0,004	0,004	0,005	0,005	0,007	0,007	0,008	0,009
4	0,006	0,004	0,005	0,005	0,006	0,007	0,009	0,009	0,011	0,011
5	0,007	0,005	0,006	0,006	0,008	0,009	0,011	0,011	0,013	0,014
6	0,008	0,006	0,007	0,008	0,009	0,010	0,013	0,014	0,015	0,016
8	0,012	0,008	0,009	0,011	0,013	0,014	0,018	0,019	0,021	0,022
10	0,014	0,010	0,011	0,013	0,016	0,017	0,021	0,023	0,026	0,027
12	0,020	0,014	0,016	0,018	0,021	0,023	0,029	0,031	0,035	0,037
14	0,021	0,015	0,017	0,019	0,023	0,025	0,031	0,033	0,037	0,040
16	0,023	0,016	0,019	0,021	0,026	0,028	0,035	0,037	0,042	0,044
18	0,027	0,019	0,022	0,025	0,030	0,033	0,041	0,044	0,049	0,052
20	0,029	0,020	0,023	0,026	0,032	0,035	0,044	0,047	0,053	0,056
25	0,036	0,025	0,029	0,033	0,040	0,044	0,055	0,058	0,066	0,069

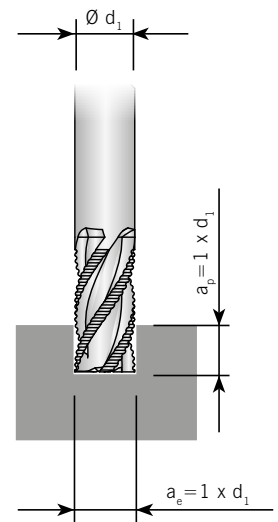

**Achtung:** Für unbeschichtete Werkzeuge ist der Vorschub um 10-20% zu reduzieren.

Attention: Feed rates are reduced by 10-20% for uncoated tools.

Attention: Pour les outils sans revêtement, l'avance doit être réduite de 10 à 20 %.

## Vorschübe für Vollradius- und Torusfräser

Feed rates for ball nosed- and High feed cutters

Avances pour les fraises à rayon complet et toriques

AF

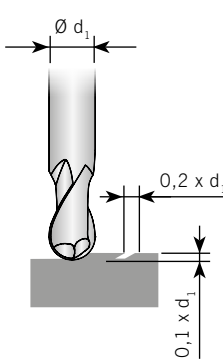
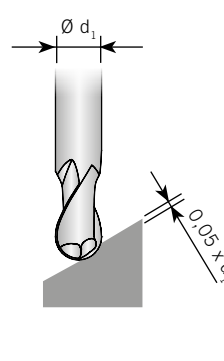
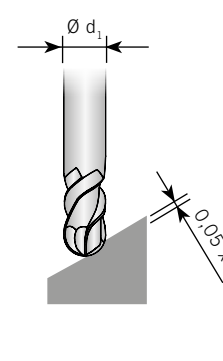
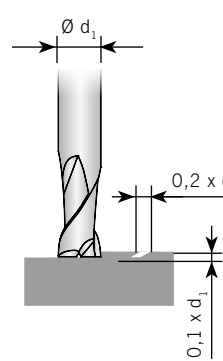
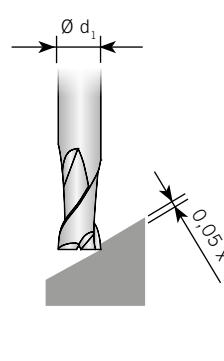
	<b>Radiusfräser</b> Ball nose end milling cutters Fraise à rayon	<b>Radiusfräser</b> Ball nose end milling cutters Fraise à rayon	<b>Formenbau-Radiusfräser</b> Ball nose cutter for mold and die production Fraise à rayon pour la fabrication de moules	<b>Torusfräser</b> Torus end milling cutters Fraise torique	<b>Torusfräser</b> Torus end milling cutters Fraise torique
					
$d_1$ [mm]	$fz$ [mm]	$fz$ [mm]	$fz$ [mm]	$fz$ [mm]	$fz$ [mm]
2	0,015	0,010	0,005	0,010	0,015
3	0,030	0,020	0,015	0,015	0,020
4	0,040	0,030	0,030	0,020	0,030
5	0,060	0,050	0,050	0,030	0,040
6	0,070	0,060	0,060	0,050	0,060
8	0,100	0,080	0,070	0,070	0,080
10	0,120	0,100	0,080	0,080	0,100
12	0,150	0,120	0,090	0,100	0,120
16	0,180	0,150	0,100	0,120	0,150
18	0,200	0,180	0,110	0,140	0,160
20	0,220	0,200	0,120	0,150	0,180
25	0,240	0,220	0,140	0,160	0,200

**Achtung:** Für unbeschichtete Werkzeuge ist der Vorschub um 10-20% zu reduzieren.

Attention: Feed rates are reduced by 10-20% for uncoated tools.

Attention: Pour les outils sans revêtement, l'avance doit être réduite de 10 à 20 %.



# ARNO®

## WERKZEUGE

We have a passion for precision.

# AUSFÜHRUNG AFA

*Design AFA / Modèle AFA*

**„High Performance“ bei der Zerspanung  
von Aluminium und Nichteisenmetallen.**

*High performance for aluminium  
and non-ferrous materials.*

*Hautes performances pour l'usinage  
de l'aluminium et des métaux non ferreux.*

**Die speziell entwickelte Geometrie  
mit höchststabiler Schneidkante  
gewährleistet beste Oberflächengüte  
bei ausgezeichneter Spanabfuhr.**

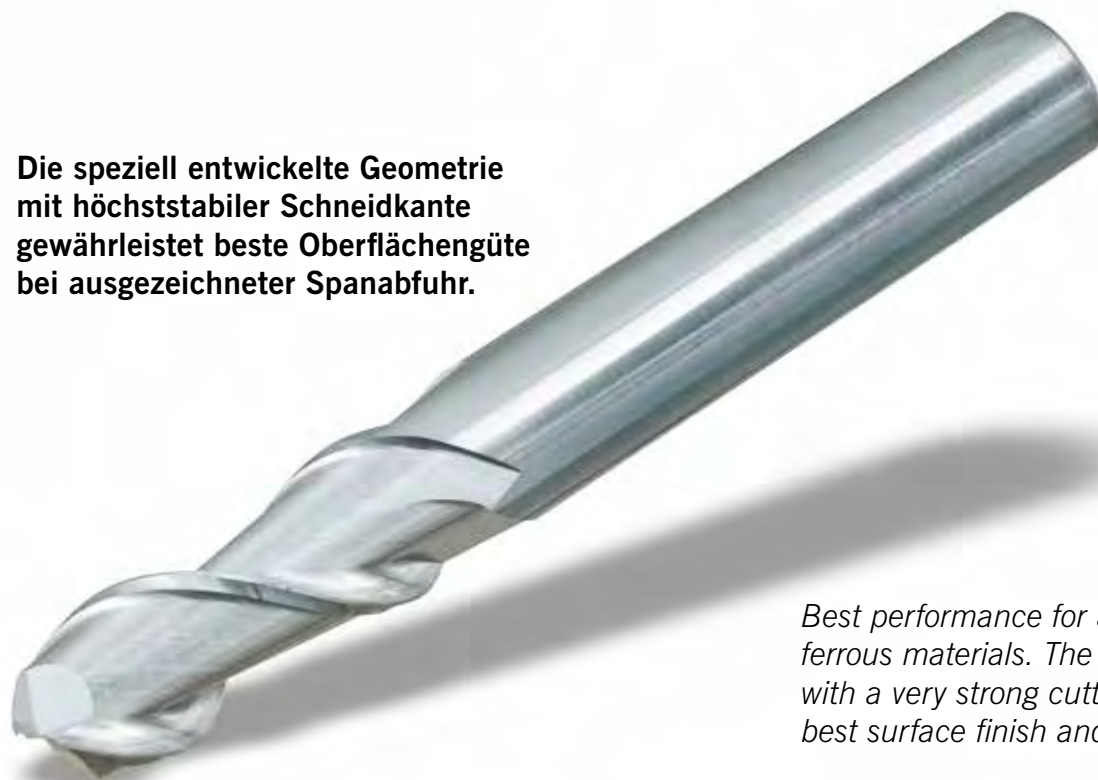

*Best performance for aluminium and non-ferrous materials. The dedicated geometry with a very strong cutting edge guarantees best surface finish and excellent chip flow.*

La géométrie spécialement conçue avec tranchant extrêmement stable garantit une finition de surface optimale et une excellente évacuation des copeaux.

Solid carbide end-mill

Fraise carbure monobloc à tige

## AFA50116-...

1 Schneide, mittellange Ausführung / 1 flute, mid-length design / 1 dent, version mi-longue

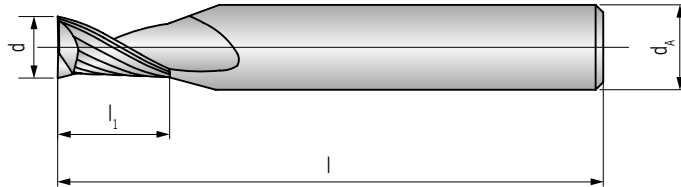

AFA

						PG 24
						beschichtet coated revêtu
Schaft DIN 6535HA Shank Tige	d -0,03	d <sub>A</sub> h6	l <sub>1</sub>	l	TiCN	
AFA50116-020	2	3	8	50	●	
AFA50116-030	3	3	12	50	●	
AFA50116-040	4	4	15	60	●	
AFA50116-050	5	5	17	60	●	
AFA50116-060	6	6	20	65	●	
AFA50116-080	8	8	22	65	●	
AFA50116-100	10	10	25	75	●	
AFA50116-120	12	12	30	80	●	

P	
M	
K	
N	●
S	
H	

● Hauptanwendung  
Main application  
Application principale

○ Nebenanwendung  
Secondary application  
Application secondaire

Solid carbide end-mill  
Fraise carbure monobloc à tige

## AFA50220-...

2 Schneiden, kurze Ausführung / 2 flutes, short design / 2 dents, version courte

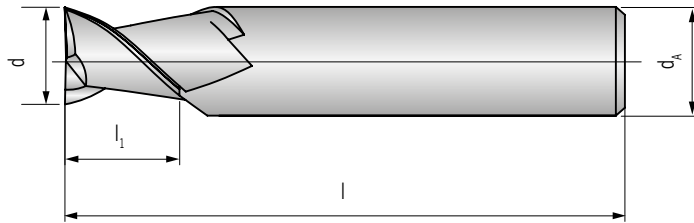

AFA

						PG 24
						beschichtet coated revêtu
Schaft DIN 6535HA Shank Tige	d -0,015	d <sub>A</sub> h6	l <sub>1</sub>	l	TiCN	
AFA50220-030	3	6	5	50	●	
AFA50220-040	4	6	8	54	●	
AFA50220-050	5	6	9	54	●	
AFA50220-060	6	6	10	54	●	
AFA50220-080	8	8	12	58	●	
AFA50220-100	10	10	14	66	●	
AFA50220-120	12	12	16	73	●	
AFA50220-140	14	14	18	75	●	
AFA50220-160	16	16	22	82	●	
AFA50220-180	18	18	24	84	●	
AFA50220-200	20	20	26	92	●	

P	
M	
K	
N	●
S	
H	

● **Hauptanwendung**  
Main application  
Application principale

○ **Nebenanwendung**  
Secondary application  
Application secondaire

Solid carbide ball-nose end-mill  
Fraise carbure monobloc hémisphérique

## AFA51820-...

2 Schneiden, kurze Ausführung / 2 flutes, short design / 2 dents, version courte

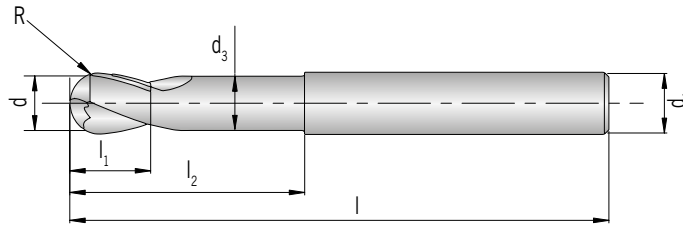

AFA

									PG 24
									beschichtet coated revêtu
Schaft DIN 6535HA Shank Tige	d -0,02	d <sub>A</sub> h6	d <sub>3</sub>	l <sub>1</sub>	l <sub>2</sub>	l	R ±0,01	TiCN	
AFA51820-060	6	6	5,4	5,5	25	55	3	●	
AFA51820-080	8	8	7,2	7,0	30	65	4	●	
AFA51820-100	10	10	9,0	8,5	35	75	5	●	
AFA51820-120	12	12	11,0	10,5	40	75	6	●	
AFA51820-160	16	16	14,5	14,0	50	90	8	●	
AFA51820-200	20	20	18,0	17,0	50	100	10	●	

P	
M	
K	
N	●
S	
H	

● Hauptanwendung  
Main application  
Application principale

○ Nebenanwendung  
Secondary application  
Application secondaire

Solid carbide end-mill  
Fraise carbure monobloc à tige

## AFA51521-...

2 Schneiden, lange Ausführung, unbeschichtet / 2 flutes, long design, uncoated / 2 dents, version longue, non revêtu

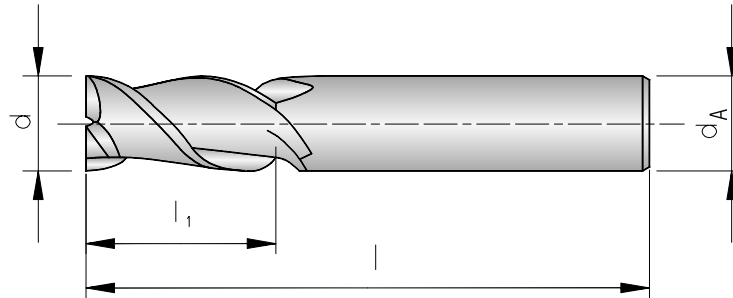

AFA

						PG 24
						unbeschichtet uncoated non-revêtu
Schaft DIN 6535HA Shank Tige	d -0,03	d <sub>A</sub> h6	l <sub>1</sub>	l	AK1010	
AFA51521-030	3	6	8	57	●	
AFA51521-040	4	6	11	57	●	
AFA51521-050	5	6	13	57	●	
AFA51521-060	6	6	13	57	●	
AFA51521-080	8	8	19	63	●	
AFA51521-100	10	10	22	72	●	
AFA51521-120	12	12	26	83	●	
AFA51521-160	16	16	32	92	●	
AFA51521-200	20	20	38	104	●	

P	
M	
K	
N	●
S	
H	

● **Hauptanwendung**  
Main application  
Application principale

○ **Nebenanwendung**  
Secondary application  
Application secondaire

Solid carbide end-mill

Fraise carbure monobloc à tige

## AFA50720-...R...

2 Schneiden, lange Ausführung mit Eckenradius / 2 flutes, long design with corner radius / 2 dents, version longue, avec rayon d'angle

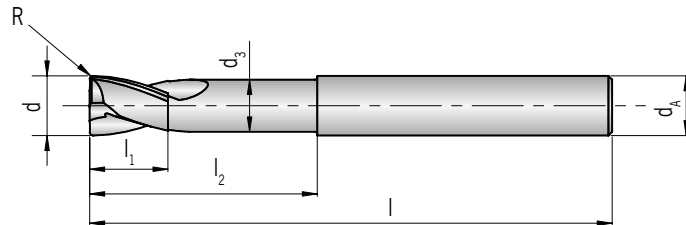
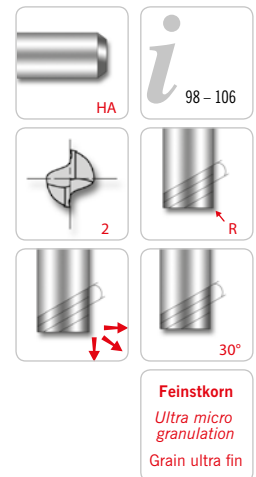

									PG 24
									beschichtet coated revêtu
Schaft DIN 6535HA Shank Tige	d -0,03	d <sub>A</sub> h6	d <sub>3</sub>	l <sub>1</sub>	l <sub>2</sub>	l	R	TiCN	
AFA50720-040R0,3	4	6	3,6	5	10	50	0,3	●	
AFA50720-060R0,5	6	6	5,4	8	20	60	0,5	●	
AFA50720-080R0,6	8	8	7,2	10	30	70	0,6	●	
AFA50720-100R0,8	10	10	9,0	12	36	80	0,8	●	
AFA50720-120R1,0	12	12	11,0	14	40	90	1,0	●	
AFA50720-160R1,3	16	16	14,5	18	45	100	1,3	●	
AFA50720-200R1,6	20	20	18,0	24	45	100	1,6	●	

P	
M	
K	
N	●
S	
H	

● Hauptanwendung  
Main application  
Application principale

○ Nebenanwendung  
Secondary application  
Application secondaire

Solid carbide end-mill  
Fraise carbure monobloc à tige

## AFA51522-...

2 Schneiden, extra lange Ausführung / 2 flutes, extra long design / 2 dents, version extra longue

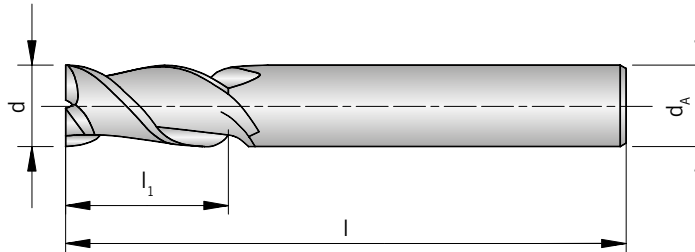

AFA

						PG 24
						beschichtet coated revêtu
Schaft DIN 6535HA Shank Tige	d -0,03	d <sub>A</sub> h6	l <sub>1</sub>	l	TiCN	
AFA51522-010	1,0	6	3	40	●	
AFA51522-015	1,5	6	5	40	●	
AFA51522-020	2,0	6	6	40	●	
AFA51522-025	2,5	6	8	40	●	
AFA51522-030	3,0	6	11	50	●	
AFA51522-040	4,0	6	13	50	●	
AFA51522-040A	4,0	6	16	70	●	
AFA51522-050	5,0	6	17	55	●	
AFA51522-050A	5,0	6	22	70	●	
AFA51522-060	6,0	6	17	55	●	
AFA51522-060A	6,0	6	22	70	●	
AFA51522-070	7,0	8	22	65	●	
AFA51522-080	8,0	8	22	65	●	
AFA51522-080A	8,0	8	28	80	●	
AFA51522-090	9,0	10	27	70	●	
AFA51522-100	10,0	10	27	70	●	
AFA51522-100A	10,0	10	32	90	●	
AFA51522-120	12,0	12	32	80	●	
AFA51522-120A	12,0	12	38	95	●	
AFA51522-140	14,0	14	37	85	●	
AFA51522-160	16,0	16	42	100	●	
AFA51522-160A	16,0	16	52	110	●	
AFA51522-180	18,0	16	48	110	●	
AFA51522-200	20,0	20	48	110	●	
AFA51522-200A	20,0	20	55	110	●	

P	
M	
K	
N	●
S	
H	

● Hauptanwendung  
Main application  
Application principale

○ Nebenanwendung  
Secondary application  
Application secondaire

Solid carbide end-mill

Fraise carbure monobloc à tige

## AFA50222-...

2 Schneiden, extra lange Ausführung / 2 flutes, extra long design / 2 dents, version extra longue

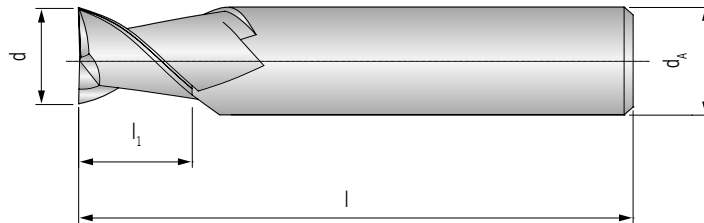

AFA

						PG 24
						beschichtet coated revêtu
Schaft DIN 6535HA Shank Tige	d -0,015	d <sub>A</sub> h6	l <sub>1</sub>	l	TiCN	
AFA50222-010A	1,0	6	3	50	●	
AFA50222-010B	1,0	6	6	60	●	
AFA50222-012A	1,2	6	4	50	●	
AFA50222-015A	1,5	6	5	50	●	
AFA50222-015B	1,5	6	8	60	●	
AFA50222-020A	2,0	6	6	50	●	
AFA50222-020B	2,0	6	10	60	●	
AFA50222-025A	2,5	6	8	55	●	
AFA50222-030A	3,0	6	11	55	●	
AFA50222-030B	3,0	6	15	65	●	
AFA50222-040A	4,0	6	13	55	●	
AFA50222-040B	4,0	6	16	65	●	
AFA50222-050A	5,0	6	17	55	●	
AFA50222-050B	5,0	6	22	60	●	
AFA50222-060A	6,0	6	17	60	●	
AFA50222-060B	6,0	6	25	70	●	
AFA50222-070A	7,0	8	22	65	●	
AFA50222-080A	8,0	8	22	70	●	
AFA50222-080B	8,0	8	30	80	●	
AFA50222-100A	10,0	10	27	75	●	
AFA50222-100B	10,0	10	35	90	●	
AFA50222-120A	12,0	12	32	80	●	
AFA50222-120B	12,0	12	40	95	●	
AFA50222-140A	14,0	16	37	90	●	
AFA50222-160A	16,0	16	42	100	●	
AFA50222-160B	16,0	16	52	110	●	



Solid carbide end-mill

Fraise carbure monobloc à tige

						PG 24
						beschichtet coated revêtu
Schaft DIN 6535HA Shank Tige	d -0,015	d <sub>A</sub> h6	l <sub>1</sub>	l	TiCN	
AFA50222-180A	18,0	16	48	100	●	
AFA50222-200A	20,0	20	48	100	●	
AFA50222-200B	20,0	20	55	110	●	

P	
M	
K	
N	●
S	
H	

- **Hauptanwendung**  
Main application  
Application principale
- **Nebenanwendung**  
Secondary application  
Application secondaire

Solid carbide end-mill  
Fraise carbure monobloc à tige

## AFA51836-...

3 Schneiden, mittellange Ausführung / 3 flutes, mid-length design / 3 dents, version mi-longue

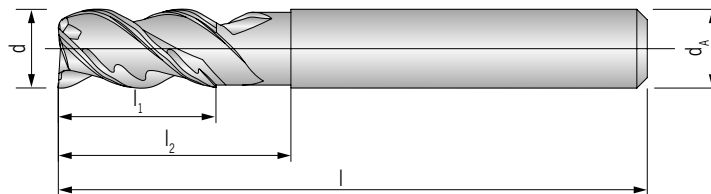

AFA

							PG 24
							beschichtet coated revêtu
Schaft DIN 6535HA Shank Tige	d -0,03	d <sub>A</sub> h6	l <sub>1</sub>	l <sub>2</sub>	l	TiCN	
AFA51836-060	6	6	13	20	70	●	
AFA51836-080	8	8	19	26	80	●	
AFA51836-100	10	10	22	32	80	●	
AFA51836-120	12	12	26	36	90	●	
AFA51836-140	14	16	28	40	110	●	
AFA51836-160	16	16	32	46	120	●	
AFA51836-180	18	20	35	50	120	●	
AFA51836-200	20	20	38	52	120	●	

P	
M	
K	
N	●
S	
H	

● Hauptanwendung  
Main application  
Application principale

○ Nebenanwendung  
Secondary application  
Application secondaire

Solid carbide end-mill

Fraise carbure monobloc à tige

## AFA52336-...

**3 Schneiden, mittellange Ausführung, abgesetzter Schaft** / 3 flutes, mid-length design, with neck / 3 dents, version mi-longue, tige dégagée

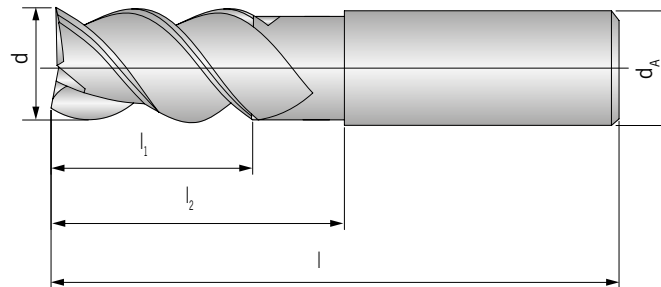

							PG 24
							beschichtet coated revêtu
Schaft DIN 6535HA Shank Tige	d -0,015	d <sub>A</sub> h6	l <sub>1</sub>	l <sub>2</sub>	l	TiCN	
AFA52336-030	3	6	8	12	57	●	
AFA52336-040	4	6	11	18	57	●	
AFA52336-050	5	6	13	18	57	●	
AFA52336-060	6	6	13	18	57	●	
AFA52336-080	8	8	21	25	63	●	
AFA52336-100	10	10	22	30	72	●	
AFA52336-120	12	12	26	36	83	●	
AFA52336-160	16	16	36	42	92	●	
AFA52336-200	20	20	41	52	104	●	

P	
M	
K	
N	●
S	
H	

● **Hauptanwendung**  
Main application  
Application principale

○ **Nebenanwendung**  
Secondary application  
Application secondaire

## AFA52330-...

**3 Schneiden, lange Ausführung, unbeschichtet** / 3 flutes, long design, uncoated / 3 dents, version longue, non revêtu

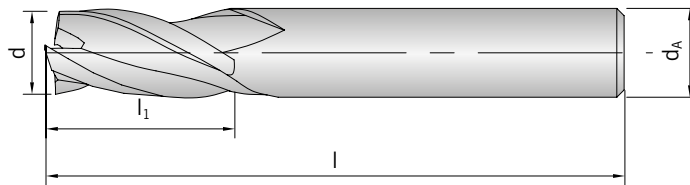

AFA

PG 24					
unbeschichtet uncoated non-revêtu					
Schaft DIN 6535HA Shank Tige	d h10	d <sub>A</sub> h6	l <sub>1</sub>	l	AK1010
AFA52330-035	3,5	3,5	7	50	●
AFA52330-040	4,0	4,0	8	50	●
AFA52330-045	4,5	4,5	8	50	●
AFA52330-050	5,0	5,0	10	50	●
AFA52330-055	5,5	5,5	10	57	●
AFA52330-060	6,0	6,0	10	57	●
AFA52330-065	6,5	6,5	13	60	●
AFA52330-070	7,0	7,0	13	60	●
AFA52330-075	7,5	7,5	16	63	●
AFA52330-080	8,0	8,0	16	63	●
AFA52330-085	8,5	8,5	16	67	●
AFA52330-090	9,0	9,0	16	67	●
AFA52330-095	9,5	9,5	19	72	●
AFA52330-100	10,0	10,0	19	72	●
AFA52330-110	11,0	11,0	22	83	●
AFA52330-120	12,0	12,0	22	83	●
AFA52330-130	13,0	13,0	22	83	●
AFA52330-140	14,0	14,0	22	83	●
AFA52330-150	15,0	15,0	26	92	●
AFA52330-160	16,0	16,0	26	92	●
AFA52330-180	18,0	18,0	26	92	●
AFA52330-200	20,0	20,0	32	104	●

P	
M	
K	
N	●
S	
H	

● Hauptanwendung  
Main application  
Application principale

○ Nebenanwendung  
Secondary application  
Application secondaire

Solid carbide end-mill  
Fraise carbure monobloc à tige

## AFA51531...

3 Schneiden, lange Ausführung / 3 flutes, long design / 3 dents, version longue

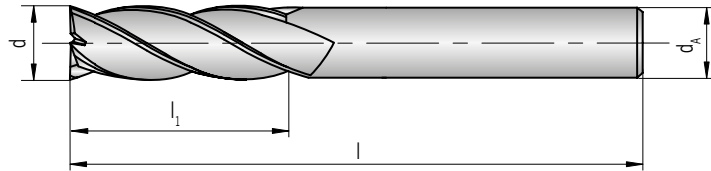

AFA

						PG 24
						beschichtet coated revêtu
Schaft DIN 6535HA Shank Tige	d -0,03	d <sub>A</sub> h6	l <sub>1</sub>	l	TiCN	
AFA51531-030	3	6	11	50	●	
AFA51531-030A	3	6	14	65	●	
AFA51531-040	4	6	13	50	●	
AFA51531-040A	4	6	16	65	●	
AFA51531-050	5	6	17	55	●	
AFA51531-050A	5	6	22	70	●	
AFA51531-060	6	6	17	55	●	
AFA51531-060A	6	6	22	70	●	
AFA51531-070	7	8	22	65	●	
AFA51531-080	8	8	22	65	●	
AFA51531-080A	8	8	28	80	●	
AFA51531-090	9	10	27	70	●	
AFA51531-100	10	10	27	70	●	
AFA51531-100A	10	10	32	90	●	
AFA51531-120	12	12	32	80	●	
AFA51531-120A	12	12	38	95	●	
AFA51531-140	14	14	37	85	●	
AFA51531-160	16	16	42	100	●	
AFA51531-160A	16	16	52	110	●	
AFA51531-180	18	16	48	110	●	
AFA51531-200	20	20	48	110	●	
AFA51531-200A	20	20	55	110	●	

P	
M	
K	
N	●
S	
H	

● Hauptanwendung  
Main application  
Application principale

○ Nebenanwendung  
Secondary application  
Application secondaire

## AFA50231-...R...

**3 Schneiden, lange Ausführung, mit Eckenradius / 3 flutes, long design, with corner radius / 3 dents, version longue, avec rayon d'angle**

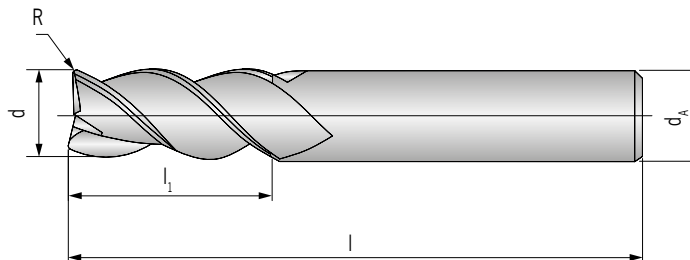
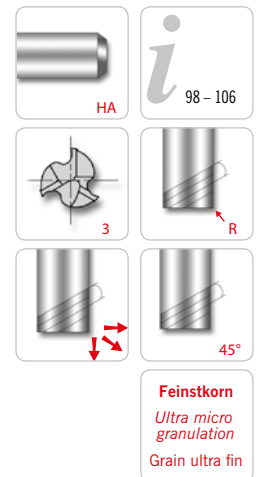

							PG 24
							beschichtet coated revêtu
Schaft DIN 6535HA Shank Tige	d -0,015	d <sub>A</sub> h6	l <sub>1</sub>	l	R	TiCN	
AFA50231-030R0,5	3	6	12	57	0,5	●	
AFA50231-030R1,0	3	6	12	57	1,0	●	
AFA50231-040R0,5	4	6	15	57	0,5	●	
AFA50231-040R1,0	4	6	15	57	1,0	●	
AFA50231-050R0,5	5	6	20	57	0,5	●	
AFA50231-050R1,0	5	6	20	57	1,0	●	
AFA50231-060R0,5	6	6	20	65	0,5	●	
AFA50231-060R1,0	6	6	20	65	1,0	●	
AFA50231-080R0,5	8	8	22	65	0,5	●	
AFA50231-080R1,0	8	8	22	65	1,0	●	
AFA50231-100R0,5	10	10	25	70	0,5	●	
AFA50231-100R1,0	10	10	25	70	1,0	●	
AFA50231-100R2,0	10	10	25	70	2,0	●	
AFA50231-120R0,5	12	12	25	75	0,5	●	
AFA50231-120R1,0	12	12	25	75	1,0	●	
AFA50231-120R2,0	12	12	25	75	2,0	●	
AFA50231-160R0,5	16	16	35	90	0,5	●	
AFA50231-160R1,0	16	16	35	90	1,0	●	
AFA50231-160R2,0	16	16	35	90	2,0	●	
AFA50231-200R0,5	20	20	40	100	0,5	●	
AFA50231-200R1,0	20	20	40	100	1,0	●	
AFA50231-200R2,0	20	20	40	100	2,0	●	

P	
M	
K	
N	●
S	
H	

● Hauptanwendung  
Main application  
Application principale

○ Nebenanwendung  
Secondary application  
Application secondaire

Solid carbide end-mill  
Fraise carbure monobloc à tige

## AFA51532-...

3 Schneiden, extra lange Ausführung / 3 flutes, extra long design / 3 dents, version extra longue

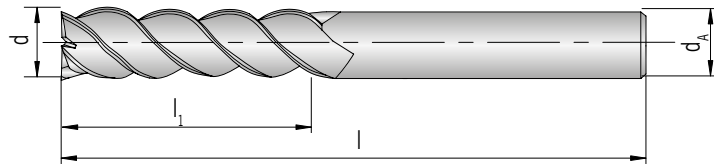

AFA

						PG 24
						beschichtet coated revêtu
Schaft DIN 6535HA Shank Tige	d -0,03	d <sub>A</sub> h6	l <sub>1</sub>	l	TiCN	
AFA51532-030A	3	6	15	65	●	
AFA51532-030B	3	6	20	70	●	
AFA51532-030C	3	6	25	75	●	
AFA51532-040A	4	6	20	70	●	
AFA51532-040B	4	6	25	75	●	
AFA51532-040C	4	6	30	80	●	
AFA51532-050A	5	6	25	70	●	
AFA51532-050B	5	6	30	75	●	
AFA51532-050C	5	6	35	80	●	
AFA51532-060A	6	6	25	70	●	
AFA51532-060B	6	6	30	75	●	
AFA51532-060C	6	6	35	80	●	
AFA51532-060D	6	6	42	90	●	
AFA51532-080A	8	8	30	80	●	
AFA51532-080B	8	8	35	85	●	
AFA51532-080C	8	8	40	90	●	
AFA51532-080D	8	8	45	95	●	
AFA51532-100A	10	10	35	90	●	
AFA51532-100B	10	10	45	100	●	
AFA51532-100C	10	10	55	110	●	
AFA51532-100D	10	10	65	120	●	
AFA51532-120A	12	12	40	95	●	
AFA51532-120B	12	12	45	100	●	
AFA51532-120C	12	12	55	110	●	
AFA51532-120D	12	12	65	120	●	
AFA51532-120E	12	12	75	135	●	
AFA51532-120F	12	12	60	110	●	
AFA51532-160A	16	16	55	120	●	
AFA51532-160B	16	16	65	135	●	
AFA51532-160C	16	16	75	150	●	
AFA51532-160D	16	16	85	160	●	
AFA51532-160E	16	16	95	180	●	

PG 24

beschichtet  
coated  
revêtu

Schaft DIN 6535HA Shank Tige	d -0,03	d <sub>A</sub> h6	l <sub>1</sub>	l	TiCN
AFA51532-160F	16	16	105	190	●
AFA51532-160G	16	16	115	200	●
AFA51532-200A	20	20	55	125	●
AFA51532-200B	20	20	65	140	●
AFA51532-200C	20	20	75	150	●
AFA51532-200D	20	20	85	160	●
AFA51532-200E	20	20	95	180	●
AFA51532-200F	20	20	105	190	●
AFA51532-200G	20	20	115	200	●
AFA51532-200H	20	20	125	220	●

P	
M	
K	
N	●
S	
H	

● **Hauptanwendung**  
Main application  
Application principale

○ **Nebenanwendung**  
Secondary application  
Application secondaire



## AFA50232-...

3 Schneiden, extra lange Ausführung / 3 flutes, extra long design / 3 dents, version extra longue



AFA

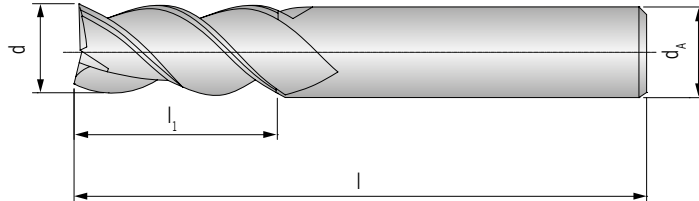

						PG 24
						beschichtet coated revêtu
Schaft DIN 6535HA Shank Tige	d -0,015	d <sub>A</sub> h6	l <sub>1</sub>	l	TiCN	
AFA50232-010A	1,0	6	3,0	50	●	
AFA50232-010B	1,0	6	2,0	40	●	
AFA50232-010C	1,0	6	2,5	40	●	
AFA50232-010D	1,0	6	4,0	60	●	
AFA50232-010E	1,0	6	6,0	60	●	
AFA50232-012A	1,2	6	4,0	50	●	
AFA50232-015A	1,5	6	5,0	50	●	
AFA50232-015B	1,5	6	3,0	40	●	
AFA50232-015C	1,5	6	8,0	60	●	
AFA50232-015D	1,5	6	10,0	60	●	
AFA50232-020A	2,0	6	6,0	50	●	
AFA50232-020B	2,0	6	3,0	40	●	
AFA50232-020C	2,0	6	8,0	60	●	
AFA50232-020D	2,0	6	10,0	60	●	
AFA50232-020E	2,0	6	12,0	60	●	
AFA50232-025A	2,5	6	10,0	55	●	
AFA50232-025B	2,5	6	8,0	40	●	
AFA50232-025C	2,5	6	12,0	60	●	
AFA50232-030A	3,0	6	11,0	55	●	
AFA50232-030B	3,0	6	4,0	45	●	
AFA50232-030C	3,0	6	8,0	45	●	
AFA50232-030D	3,0	6	15,0	65	●	
AFA50232-030E	3,0	6	20,0	70	●	
AFA50232-030F	3,0	6	25,0	75	●	
AFA50232-030G	3,0	6	30,0	80	●	
AFA50232-035A	3,5	6	12,0	55	●	
AFA50232-040A	4,0	6	13,0	55	●	
AFA50232-040B	4,0	6	5,0	45	●	
AFA50232-040C	4,0	6	11,0	45	●	
AFA50232-040D	4,0	6	16,0	65	●	
AFA50232-040E	4,0	6	20,0	70	●	
AFA50232-040F	4,0	6	26,0	75	●	

PG 24

beschichtet  
coated  
revêtu

Schaft DIN 6535HA Shank Tige	d -0,015	d <sub>A</sub> h6	l <sub>1</sub>	l	TiCN
AFA50232-040G	4,0	6	30,0	80	●
AFA50232-045A	4,5	6	15,0	55	●
AFA50232-050A	5,0	6	17,0	55	●
AFA50232-050B	5,0	6	6,0	45	●
AFA50232-050C	5,0	6	22,0	60	●
AFA50232-050D	5,0	6	25,0	70	●
AFA50232-050E	5,0	6	30,0	75	●
AFA50232-050F	5,0	6	35,0	80	●
AFA50232-050G	5,0	6	40,0	85	●
AFA50232-050H	5,0	6	45,0	90	●
AFA50232-055A	5,5	6	17,0	55	●
AFA50232-060A	6,0	6	17,0	60	●
AFA50232-060B	6,0	6	7,0	50	●
AFA50232-060C	6,0	6	13,0	50	●
AFA50232-060D	6,0	6	22,0	60	●
AFA50232-060E	6,0	6	25,0	70	●
AFA50232-060F	6,0	6	30,0	75	●
AFA50232-060G	6,0	6	35,0	80	●
AFA50232-060H	6,0	6	42,0	90	●
AFA50232-060I	6,0	6	50,0	100	●
AFA50232-070A	7,0	8	22,0	65	●
AFA50232-080A	8,0	8	22,0	70	●
AFA50232-080B	8,0	8	9,0	60	●
AFA50232-080C	8,0	8	19,0	60	●
AFA50232-080D	8,0	8	28,0	80	●
AFA50232-080E	8,0	8	30,0	80	●
AFA50232-080F	8,0	8	35,0	85	●
AFA50232-080G	8,0	8	40,0	90	●
AFA50232-080H	8,0	8	45,0	95	●
AFA50232-080I	8,0	8	50,0	100	●
AFA50232-080J	8,0	8	55,0	105	●
AFA50232-080K	8,0	8	65,0	110	●
AFA50232-090A	9,0	10	27,0	70	●
AFA50232-100A	10,0	10	27,0	75	●
AFA50232-100B	10,0	10	11,0	65	●
AFA50232-100C	10,0	10	22,0	65	●
AFA50232-100D	10,0	10	32,0	90	●
AFA50232-100E	10,0	10	35,0	90	●
AFA50232-100F	10,0	10	40,0	90	●
AFA50232-100G	10,0	10	45,0	100	●
AFA50232-100H	10,0	10	50,0	100	●
AFA50232-100I	10,0	10	55,0	110	●
AFA50232-100J	10,0	10	60,0	110	●
AFA50232-100K	10,0	10	65,0	120	●
AFA50232-120A	12,0	12	32,0	80	●
AFA50232-120B	12,0	12	13,0	70	●
AFA50232-120C	12,0	12	26,0	70	●
AFA50232-120D	12,0	12	40,0	95	●
AFA50232-120E	12,0	12	45,0	100	●
AFA50232-120F	12,0	12	50,0	100	●
AFA50232-120G	12,0	12	55,0	110	●
AFA50232-120H	12,0	12	60,0	110	●
AFA50232-120I	12,0	12	65,0	120	●
AFA50232-120J	12,0	12	70,0	120	●
AFA50232-120K	12,0	12	75,0	135	●
AFA50232-140A	14,0	16	37,0	90	●

						PG 24
						beschichtet coated revêtu
Schaft DIN 6535HA Shank Tige	d -0,015	d <sub>A</sub> h6	l <sub>1</sub>	l	TiCN	
AFA50232-160A	16,0	16	18,0	90	●	
AFA50232-160B	16,0	16	32,0	90	●	
AFA50232-160C	16,0	16	42,0	100	●	
AFA50232-160D	16,0	16	52,0	105	●	
AFA50232-160E	16,0	16	55,0	110	●	
AFA50232-160F	16,0	16	65,0	130	●	
AFA50232-160G	16,0	16	75,0	150	●	
AFA50232-160H	16,0	16	85,0	160	●	
AFA50232-160I	16,0	16	95,0	180	●	
AFA50232-160J	16,0	16	105,0	190	●	
AFA50232-160K	16,0	16	115,0	200	●	
AFA50232-180A	18,0	16	48,0	100	●	
AFA50232-200A	20,0	20	22,0	90	●	
AFA50232-200B	20,0	20	38,0	90	●	
AFA50232-200C	20,0	20	48,0	100	●	
AFA50232-200D	20,0	20	55,0	110	●	
AFA50232-200E	20,0	20	65,0	130	●	
AFA50232-200F	20,0	20	75,0	150	●	
AFA50232-200G	20,0	20	85,0	160	●	
AFA50232-200H	20,0	20	95,0	180	●	
AFA50232-200I	20,0	20	105,0	190	●	
AFA50232-200J	20,0	20	115,0	200	●	
AFA50232-200K	20,0	20	125,0	220	●	

P	
M	
K	
N	●
S	
H	

- **Hauptanwendung**  
Main application  
Application principale
- **Nebenanwendung**  
Secondary application  
Application secondaire

Solid carbide ball-nose end-mill  
Fraise carbure monobloc hémisphérique

## AFA51831-...

3 Schneiden, kurze Ausführung / 3 flutes, short design / 3 dents, version courte

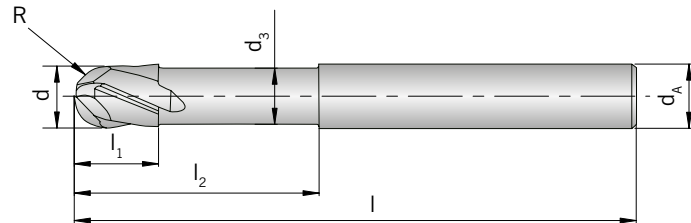

									PG 24
									beschichtet coated revêtu
Schaft DIN 6535HA Shank Tige	d -0,03	d <sub>A</sub> h6	d <sub>3</sub>	l <sub>1</sub>	l <sub>2</sub>	l	R ±0,01	TiCN	
AFA51831-020	2,0	6	1,9	3,0	5,0	60	1,00	●	
AFA51831-025	2,5	6	2,4	4,0	6,0	60	1,25	●	
AFA51831-030	3,0	6	2,8	4,5	6,5	60	1,50	●	
AFA51831-035	3,5	6	3,2	5,0	7,0	65	1,75	●	
AFA51831-040	4,0	6	3,7	6,0	8,0	65	2,00	●	
AFA51831-050	5,0	6	4,6	7,5	10,0	65	2,50	●	
AFA51831-060	6,0	6	5,6	9,0	12,0	75	3,00	●	
AFA51831-080	8,0	8	7,4	12,0	25,0	75	4,00	●	
AFA51831-100	10,0	10	9,4	15,0	30,0	80	5,00	●	
AFA51831-120	12,0	12	11,4	18,0	36,0	90	6,00	●	
AFA51831-160	16,0	16	15,4	24,0	40,0	100	8,00	●	
AFA51831-200	20,0	20	18,0	30,0	50,0	110	10,00	●	

P	
M	
K	
N	●
S	
H	

● **Hauptanwendung**  
Main application  
Application principale

○ **Nebenanwendung**  
Secondary application  
Application secondaire

Solid carbide roughing end-mill  
Fraise carbure monobloc d'ébauche

## AFA61431-...

**3 Schneiden, lange Ausführung, unbeschichtet** / 3 flutes, long design, uncoated / 3 dents, version longue, non revêtu

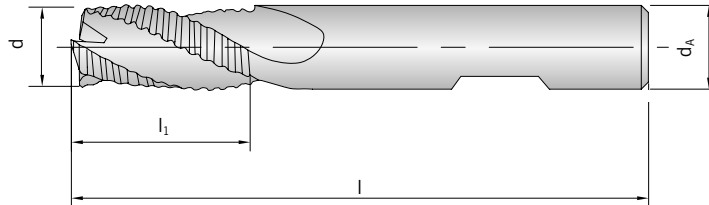

AFA

						PG 24
						unbeschichtet uncoated non-revêtu
Schaft DIN 6535HB Shank Tige	d h10	d <sub>A</sub> h6	l <sub>1</sub>	l	AK1010	
AFA61431-060	6	6	16	57	●	
AFA61431-070	7	8	16	63	●	
AFA61431-080	8	8	16	63	●	
AFA61431-090	9	10	19	72	●	
AFA61431-100	10	10	22	72	●	
AFA61431-120	12	12	26	83	●	
AFA61431-140	14	14	26	83	●	
AFA61431-160	16	16	32	92	●	
AFA61431-180	18	18	32	92	●	
AFA61431-200	20	20	38	104	●	
AFA61431-250	25	25	45	121	●	

P	
M	
K	
N	●
S	
H	

● **Hauptanwendung**  
Main application  
Application principale

○ **Nebenanwendung**  
Secondary application  
Application secondaire

Solid carbide roughing end-mill  
Fraise carbure monobloc d'ébauche

## AFA51431-...

3 Schneiden, lange Ausführung / 3 flutes, long design / 3 dents, version longue

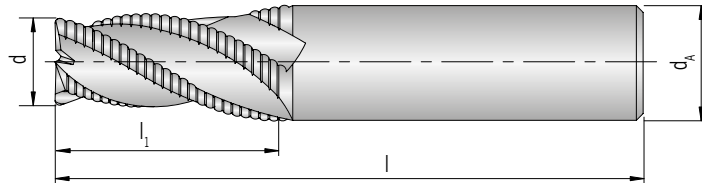

AFA

						PG 24
						beschichtet coated revêtu
Schaft DIN 6535HA Shank Tige	d js12	d <sub>A</sub> h6	l <sub>1</sub>	l	TiCN	
AFA51431-060	6	6	16	57	●	
AFA51431-070	7	8	16	63	●	
AFA51431-080	8	8	16	63	●	
AFA51431-090	9	10	19	72	●	
AFA51431-100	10	10	22	72	●	
AFA51431-120	12	12	26	83	●	
AFA51431-140	14	14	26	83	●	
AFA51431-160	16	16	32	92	●	
AFA51431-180	18	18	32	92	●	
AFA51431-200	20	20	38	104	●	
AFA51431-250	25	25	45	121	●	

P	
M	
K	
N	●
S	
H	

● **Hauptanwendung**  
Main application  
Application principale

○ **Nebenanwendung**  
Secondary application  
Application secondaire

Solid carbide roughing end-mill  
Fraise carbure monobloc d'ébauche

## AFA52131-...

3 Schneiden, lange Ausführung / 3 flutes, long design / 3 dents, version longue

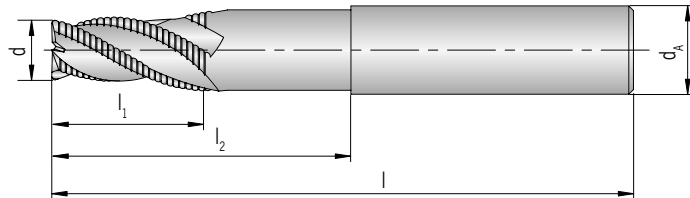

AFA

							PG 24
							beschichtet coated revêtu
Schaft DIN 6535HA Shank Tige	d js12	d <sub>A</sub> h6	l <sub>1</sub>	l <sub>2</sub>	l	Typ Type Type	TiCN
AFA52131-040A	4	6	6	14	60	M	●
AFA52131-060A	6	6	10	20	65	M	●
AFA52131-060B	6	6	18	-	60	O	●
AFA52131-060C	6	6	30	-	70	O	●
AFA52131-070A	7	8	20	-	65	O	●
AFA52131-080A	8	8	12	26	80	M	●
AFA52131-080B	8	8	20	-	65	O	●
AFA52131-080C	8	8	30	-	100	O	●
AFA52131-100A	10	10	14	30	85	M	●
AFA52131-100B	10	10	26	-	70	O	●
AFA52131-100C	10	10	40	-	100	O	●
AFA52131-120A	12	12	16	36	100	M	●
AFA52131-120B	12	12	30	-	80	O	●
AFA52131-120C	12	12	50	-	120	O	●
AFA52131-160A	16	16	20	42	110	M	●
AFA52131-160B	16	16	40	-	100	O	●
AFA52131-160C	16	16	56	-	120	O	●
AFA52131-200A	20	20	24	52	110	M	●
AFA52131-200B	20	20	46	-	100	O	●
AFA52131-200C	20	20	60	-	120	O	●

P	
M	
K	
N	●
S	
H	

● Hauptanwendung  
Main application  
Application principale  
○ Nebenanwendung  
Secondary application  
Application secondaire

Solid carbide roughing end-mill  
Fraise carbure monobloc d'ébauche

## AFA51931-...

3 Schneiden, lange Ausführung / 3 flutes, long design / 3 dents, version longue

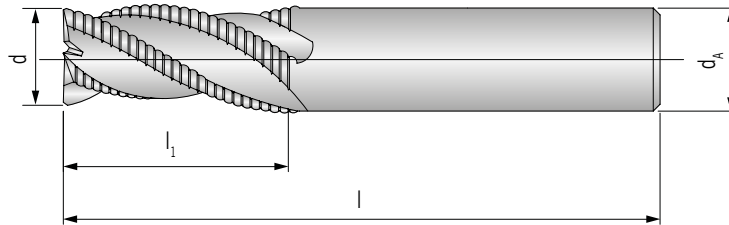

PG 24

beschichtet  
coated  
revêtu

Schaft DIN 6535HA Shank Tige	d h10	d <sub>A</sub> h6	l <sub>1</sub>	l	TiCN
AFA51931-040	4	6	10	55	●
AFA51931-050	5	6	15	55	●
AFA51931-060	6	6	15	60	●
AFA51931-060A	6	6	25	80	●
AFA51931-080	8	8	20	65	●
AFA51931-080A	8	8	30	90	●
AFA51931-100	10	10	25	70	●
AFA51931-100A	10	10	40	100	●
AFA51931-120	12	12	30	80	●
AFA51931-120A	12	12	50	110	●
AFA51931-140	14	16	35	90	●
AFA51931-160	16	16	42	100	●
AFA51931-160A	16	16	52	150	●
AFA51931-180	18	20	45	100	●
AFA51931-200	20	20	48	100	●
AFA51931-200A	20	20	55	160	●

P	
M	
K	
N	●
S	
H	

● Hauptanwendung  
Main application  
Application principale

○ Nebenanwendung  
Secondary application  
Application secondaire



Solid carbide roughing end-mill  
Fraise carbure monobloc d'ébauche

## AFA52331-...

**3 Schneiden, lange Ausführung, abgesetzter Schaft** / 3 flutes, long design, with neck / 3 dents, version longue, tige dégagée

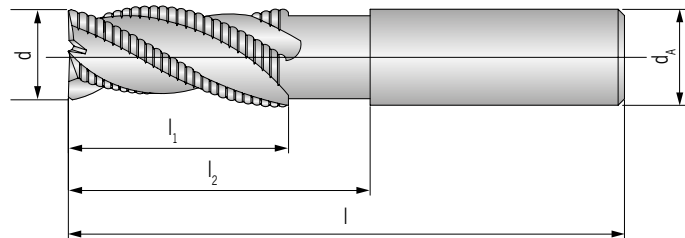

							PG 24
							beschichtet coated revêtu
Schaft DIN 6535HA Shank Tige	d h10	d <sub>A</sub> h6	l <sub>1</sub>	l <sub>2</sub>	l	TiCN	
AFA52331-040	4	6	6	12	60	●	
AFA52331-050	5	6	7	20	60	●	
AFA52331-060	6	6	8	20	70	●	
AFA52331-080	8	8	10	26	80	●	
AFA52331-100	10	10	12	32	90	●	
AFA52331-120	12	12	14	36	100	●	
AFA52331-160	16	16	18	46	120	●	
AFA52331-200	20	20	22	52	120	●	

P	
M	
K	
N	●
S	
H	

● **Hauptanwendung**  
Main application  
Application principale

○ **Nebenanwendung**  
Secondary application  
Application secondaire

Werkstoffgruppe	Gliederung der Werkstoffhauptgruppen und Kennbuchstaben		Brinell-Härte	Zugfestigkeit Rm (N/mm <sup>2</sup> )	Zerspanungsgruppe	Korrekturfaktor	Schnittgeschwindigkeit V <sub>c</sub> (m/min)		
							AK1010	VHM TiCN	
P	Unlegierter Stahl	C ≤ 0,25 %	geglüht	125	428	P1	-	-	
		C > 0,25 ... ≤ 0,55 %	geglüht	190	639	P2	-	-	
		C > 0,25 ... ≤ 0,55 %	vergütet	210	708	P3	-	-	
		C > 0,55 %	geglüht	190	639	P4	-	-	
		C > 0,55 %	vergütet	300	1013	P5	-	-	
		Automatenstahl (kurzspanend)	geglüht	220	745	P6	-	-	
	Niedrig legierter Stahl		geglüht	175	591	P7	-	-	
			vergütet	300	1013	P8	-	-	
			vergütet	380	1282	P9	-	-	
			vergütet	430	1477	P10	-	-	
	Hochlegierter Stahl und hochlegierter Werkzeugstahl		geglüht	200	675	P11	-	-	
			gehärtet und angelassen	300	1013	P12	-	-	
			gehärtet und angelassen	400	1361	P13	-	-	
	Nichtrostender Stahl		ferritisch / martensitisch, geglüht	200	675	P14	-	-	
			martensitisch, vergütet	330	1114	P15	-	-	
M	Nichtrostender Stahl		austenitisch, abgeschreckt	200	675	M1	-	-	
			austenitisch, ausscheidungsgehärtet (PH)	300	1013	M2	-	-	
			austenitisch-ferritisch, Duplex	230	778	M3	-	-	
K	Temperguss		ferritisch	200	675	K1	-	-	
			perritisch	260	867	K2	-	-	
	Grauguss		niedrige Festigkeit	180	602	K3	-	-	
			hohe Festigkeit / austenitisch	245	825	K4	-	-	
	Gusseisen mit Kugelgraphit		ferritisch	155	518	K5	-	-	
			perritisch	265	885	K6	-	-	
		GGV (CGI)		200	675	K7	-	-	
N	Aluminium-Knetlegierungen		nicht aushärtbar	30	-	N1	1,9	250 - 400 - 550	280 - 430 - 580
			aushärtbar, ausgehärtet	100	343	N2	1,8	200 - 325 - 450	220 - 350 - 480
	Aluminium-Gusslegierungen		≤ 12 % Si, nicht aushärtbar	75	260	N3	1,9	250 - 375 - 500	280 - 405 - 530
			≤ 12 % Si, aushärtbar, ausgehärtet	90	314	N4	1,7	150 - 250 - 350	170 - 265 - 360
			> 12 % Si, nicht aushärtbar	130	447	N5	1,6	100 - 175 - 250	120 - 200 - 280
		Magnesiumlegierungen		70	250	N6	1,8	100 - 150 - 200	150 - 185 - 220
	Kupfer und Kupferlegierungen (Bronze / Messing)		unlegiert, Elektrolytkupfer	100	343	N7	1,2	90 - 155 - 220	100 - 170 - 240
			Messing, Bronze, Rotguss	90	314	N8	1,1	90 - 155 - 220	100 - 175 - 250
			Cu-Legierung, kurzspanend	110	382	N9	1,1	80 - 130 - 180	90 - 155 - 220
			hochfest, Ampco	300	1013	N10	0,7	60 - 105 - 150	70 - 125 - 180
	Nichtmetallische Werkstoffe		Thermoplaste (ohne abrasive Füllstoffe)	-	-	N11	1,9	50 - 90 - 130	70 - 105 - 140
			Duroplaste (ohne abrasive Füllstoffe)	-	-	N12	1,9	90 - 150 - 210	120 - 185 - 250
			Kunststoff glasfaserverstärkt GFRP	-	-	N13	1,0	40 - 80 - 120	50 - 95 - 140
			Kunststoff kohlefaserverstärkt CFRP	-	-	N14	1,0	40 - 80 - 120	50 - 95 - 140
			Kunststoff aramidfaserverstärkt AFRP	-	-	N15	1,0	40 - 80 - 120	50 - 95 - 140
		Graphit (technisch)		80 Shore	-	N16		-	-
S	Warmfeste Legierungen		Fe-Basis	geglüht	200	675	S1	-	-
				ausgehärtet	280	943	S2	-	-
				geglüht	250	839	S3	-	-
			Ni- oder Co-Basis	ausgehärtet	350	1177	S4	-	-
				gegossen	320	1076	S5	-	-
	Titanlegierungen		Reintitan		200	675	S6	-	-
			α- und β-Legierungen, ausgehärtet		375	1262	S7	-	-
			β-Legierungen		410	1396	S8	-	-
		Wolframlegierungen		300	1013	S9	-	-	
		Molybdänlegierungen		300	1013	S10	-	-	
H	Gehärteter Stahl		gehärtet und angelassen	50 HRC	-	H1	-	-	
			gehärtet und angelassen	55 HRC	-	H2	-	-	
			gehärtet und angelassen	60 HRC	-	H3	-	-	
		Gehärtetes Gusseisen		gehärtet und angelassen	55 HRC	-	H4	-	-

Die Tabellenwerte sind Richtwerte. Es kann notwendig sein, die Werte den jeweiligen Bearbeitungsumständen anzupassen.

Material group	Structure of the material groups and identification letters		Brinell hardness HB	Tensile strength Rm (N/mm <sup>2</sup> )	Chipping group	Correction factor	Cutting speed V <sub>c</sub> (m/min)	
							AK1010	VHM TiCN
P	Unalloyed steel	C ≤ 0.25 % annealed	125	428	P1	-	-	
		C > 0.25 ... ≤ 0.55 % annealed	190	639	P2	-	-	
		C > 0.25 ... ≤ 0.55 % hardened and tempered	210	708	P3	-	-	
		C > 0.55 % annealed	190	639	P4	-	-	
		C > 0.55 % hardened and tempered	300	1013	P5	-	-	
		Machining steel (short-chipping) tempered	220	745	P6	-	-	
	Low alloyed steel	annealed	175	591	P7	-	-	
		hardened and tempered	300	1013	P8	-	-	
		hardened and tempered	380	1282	P9	-	-	
		hardened and tempered	430	1477	P10	-	-	
	High alloyed steel and high alloyed tool steel	annealed	200	675	P11	-	-	
		hardened	300	1013	P12	-	-	
		hardened	400	1361	P13	-	-	
	Stainless steel	ferritic / martensitic, annealed	200	675	P14	-	-	
		martensitic, hardened and tempered	330	1114	P15	-	-	
M	Stainless steel	austenitic, chilled	200	675	M1	-	-	
		austenitic, precipitation-hardened (PH)	300	1013	M2	-	-	
		austenitic-ferritic, Duplex	230	778	M3	-	-	
K	Malleable cast iron	ferritic	200	675	K1	-	-	
		pearlitic	260	867	K2	-	-	
	Cast iron	low tensile strength	180	602	K3	-	-	
		high tensile strength / austenitic	245	825	K4	-	-	
	Cast iron with nodular graphite	ferritic	155	518	K5	-	-	
		pearlitic	265	885	K6	-	-	
	GGV (CGI)		200	675	K7	-	-	
N	Aluminium alloys long chipping	not heat treatable	30	-	N1	1,9	250 - 400 - 550 280 - 430 - 580	
		heat treatable, heat treated	100	343	N2	1,8	200 - 325 - 450 220 - 350 - 480	
	Casted aluminium alloys	≤ 12 % Si, not heat treatable	75	260	N3	1,9	250 - 375 - 500 280 - 405 - 530	
		≤ 12 % Si, aushärtbar, ausgehärtet	90	314	N4	1,7	150 - 250 - 350 170 - 265 - 360	
		> 12 % Si, not heat treatable	130	447	N5	1,6	100 - 175 - 250 120 - 200 - 280	
	Magnesium alloys		70	250	N6	1,8	100 - 150 - 200 150 - 185 - 220	
	Copper and copper alloys (Brass / Bronze)	Unalloyed, elektrolyte copper	100	343	N7	1,2	90 - 155 - 220 100 - 170 - 240	
		Brass, Bronze	90	314	N8	1,1	90 - 155 - 220 100 - 175 - 250	
		Cu-alloys, short-chipping	110	382	N9	1,1	80 - 130 - 180 90 - 155 - 220	
		High-tensile, Ampco	300	1013	N10	0,7	60 - 105 - 150 70 - 125 - 180	
	Non-ferrous materials	Lead alloys (without abrasive filling material)	-	-	N11	1,9	50 - 90 - 130 70 - 105 - 140	
		Duroplastic (without abrasive filling material)	-	-	N12	1,9	90 - 150 - 210 120 - 185 - 250	
		Plastic glas fibre reinforced GFRP	-	-	N13	1,0	40 - 80 - 120 50 - 95 - 140	
		Plastic carbon fibre reinforced CFRP	-	-	N14	1,0	40 - 80 - 120 50 - 95 - 140	
		Plastic aramid fibre reinforced AFRP	-	-	N15	1,0	40 - 80 - 120 50 - 95 - 140	
		Graphite (tech.)	80 Shore	-	N16		-	-
S	High temperature resistant alloys	Fe-Basis	annealed	200	675	S1	-	-
			heat treated	280	943	S2	-	-
		Ni- or Co-alloyed	annealed	250	839	S3	-	-
			heat treated	350	1177	S4	-	-
			casting	320	1076	S5	-	-
	Titanium alloys	Pure titan	200	675	S6	-	-	
		α- and β-alloys, heat treated	375	1262	S7	-	-	
		β-alloys	410	1396	S8	-	-	
	Wolfram alloys		300	1013	S9	-	-	
	Molybdän alloys		300	1013	S10	-	-	
H	Hardened steel	hardened	50 HRC	-	H1	-	-	
		hardened	55 HRC	-	H2	-	-	
		hardened	60 HRC	-	H3	-	-	
	Hardened cast iron	hardened	55 HRC	-	H4	-	-	

The recommended cutting data are only approximate values. It may be necessary to adjust them to each individual machining application.



ISO	Matériaux	Dureté Brinell	Résistance (N/mm <sup>2</sup> )	Groupe d'usinage	facteur de correction	Vitesse de coupe Vc (m/min)		
						AK1010	VHM TiCN	
P	Acier non allié	C ≤ 0,25 % recuit	125	428	P1	-	-	
		C > 0,25 ... ≤ 0,55 % recuit	190	639	P2	-	-	
		C > 0,25 ... ≤ 0,55 % traité	210	708	P3	-	-	
		C > 0,55 % recuit	190	639	P4	-	-	
		C > 0,55 % traité	300	1013	P5	-	-	
	Acier faiblement allié	Aciers de décolletage (à copeaux courts) recuit	220	745	P6	-	-	
		recuit	175	591	P7	-	-	
		traité	300	1013	P8	-	-	
		traité	380	1282	P9	-	-	
		traité	430	1477	P10	-	-	
Acier allié et acier outil allié	recuit	200	675	P11	-	-		
	trempe et revenu	300	1013	P12	-	-		
	trempe et revenu	400	1361	P13	-	-		
Acier inox	ferritique, martensitique, recuit	200	675	P14	-	-		
	martensitique, traité	330	1114	P15	-	-		
M	Acier inox	austénitique	200	675	M1	-	-	
		austénitique	300	1013	M2	-	-	
		austénitique-ferritique, Duplex	230	778	M3	-	-	
K	Fonte malléable	ferritique	200	675	K1	-	-	
		perlitique	260	867	K2	-	-	
	Fonte grise	faible résistance	180	602	K3	-	-	
		haute résistance / austénitique	245	825	K4	-	-	
	Fonte à Graphite sphéroïdale	ferritique	155	518	K5	-	-	
		perlitique	265	885	K6	-	-	
	GGV (CGI)		200	675	K7	-	-	
N	Alliages de fonderie d'aluminium	ne pouvant pas subir un durcissement	30	-	N1	1,9	250 - 400 - 550	280 - 430 - 580
		pouvant subir un durcissement, durci	100	343	N2	1,8	200 - 325 - 450	220 - 350 - 480
	Alliage de fonte d'aluminium	≤ 12 % Si, ne pouvant pas subir de durcissement	75	260	N3	1,9	250 - 375 - 500	280 - 405 - 530
		≤ 12 % Si, pouvant subir un durcissement, durci	90	314	N4	1,7	150 - 250 - 350	170 - 265 - 360
		> 12 % Si, ne pouvant pas subir de durcissement	130	447	N5	1,6	100 - 175 - 250	120 - 200 - 280
	Alliage de Magnésium		70	250	N6	1,8	100 - 150 - 200	150 - 185 - 220
	Cuivre et alliage de cuivre (bronze / laiton)	non allié, cuivre électrolytique	100	343	N7	1,2	90 - 155 - 220	100 - 170 - 240
		Laiton, bronze, fonte rouge	90	314	N8	1,1	90 - 155 - 220	100 - 175 - 250
		Alliage de cuivre à copeaux courts	110	382	N9	1,1	80 - 130 - 180	90 - 155 - 220
		forte résistance, Ampco	300	1013	N10	0,7	60 - 105 - 150	70 - 125 - 180
Matériaux non métalliques	Thermoplaste (sans agents de charge abrasives)	-	-	N11	1,9	50 - 90 - 130	70 - 105 - 140	
	Duroplaste (sans agents de charge abrasives)	-	-	N12	1,9	90 - 150 - 210	120 - 185 - 250	
	Matière plastique renforcée de fibres de verre GFRP	-	-	N13	1,0	40 - 80 - 120	50 - 95 - 140	
	Matière plastique renforcé composite CFRP	-	-	N14	1,0	40 - 80 - 120	50 - 95 - 140	
	Plastique renforcé fibre aramide AFRP	-	-	N15	1,0	40 - 80 - 120	50 - 95 - 140	
	Graphite	80 Shore	-	N16		-	-	
S	Alliages réfractaires	à base de Fe recuit	200	675	S1	-	-	
		durci	280	943	S2	-	-	
		recuit	250	839	S3	-	-	
		à base Ni ou Co durci	350	1177	S4	-	-	
		jeter	320	1076	S5	-	-	
	Alliage de titane	Titane pur	200	675	S6	-	-	
		Alliages Alpha + Beta, trempé	375	1262	S7	-	-	
		Alliages Beta	410	1396	S8	-	-	
	Alliage de tungstène		300	1013	S9	-	-	
	Alliage de molybdène		300	1013	S10	-	-	
H	Acier trempé	trempe et revenu	50 HRC	-	H1	-	-	
		trempe et revenu	55 HRC	-	H2	-	-	
		trempe et revenu	60 HRC	-	H3	-	-	
	Fonte durci	trempe et revenu	55 HRC	-	H4	-	-	

Les valeurs du tableau sont indicatives. Il peut être nécessaire de les adapter aux conditions d'usinage respectives.

Für die nachfolgenden Vorschub-Richtwerte müssen die Werte je nach zu bearbeitendem Material gemäß dem in den Schnittgeschwindigkeitstabellen angegebenen Korrekturfaktor korrigiert werden.

For the following feed tables the values must be corrected depending on the material being machined in line with the correction factor.

Pour les valeurs d'avance (indicatives) suivantes, les valeurs doivent être rectifiées en fonction du matériau à usiner selon le facteur de correction indiqué dans les tableaux des vitesses de coupe.

**Beispiel für Fräser mit Schneidendurchmesser 6 mm:**

An example using a cutter with  $\varnothing$  6 mm is detailed:

Exemple pour une fraise avec un diamètre de coupe de 6 mm :

**Schnittgeschwindigkeits-Tabelle /  $V_c$ -table / Tableau des vitesses de coupe**

ISO	Werkstoff / Material / Matériau	Festigkeit Strength Résistance [N/mm <sup>2</sup> - HB]	Kf [x $f_z$ ]	TiAlN $V_c$ [m/min]
P	<b>Allgemeiner Baustahl</b> General construction steel Acier de construction en général	< 800 N/mm <sup>2</sup>	1,2	100 - 150
	<b>Automatenstahl</b> Free cutting steel Acier de décolletage	< 800 N/mm <sup>2</sup>	1,2	100 - 150
	<b>Einsatzstahl, unlegiert</b> Case hardened steel, non alloyed Acier cémenté, non allié	< 800 N/mm <sup>2</sup>	1,2	100 - 150
	<b>Einsatzstahl, legiert</b> Alloyed case hardened steel Acier cémenté, allié	< 1000 N/mm <sup>2</sup>	1	90 - 120
	<b>Vergütungsstahl, unlegiert</b> Tempering steel, non alloyed Acier de traitement, non allié	< 850 N/mm <sup>2</sup>	1,2	90 - 130
	<b>Vergütungsstahl, unlegiert</b> Tempering steel, non alloyed Acier de traitement, non allié	< 1000 N/mm <sup>2</sup>	1	60 - 90
	<b>Vergütungsstahl, legiert</b> Tempering steel, alloyed Acier de traitement, allié	< 800 N/mm <sup>2</sup>	1,2	90 - 120
	<b>Vergütungsstahl, legiert</b> Tempering steel, alloyed Acier de traitement, allié	< 1300 N/mm <sup>2</sup>	0,8	60 - 80
	<b>Stahlguss</b> Steel castings Acier coulé	< 850 N/mm <sup>2</sup>	1,2	70 - 100

**Korrekturfaktor-Tabelle /  $f_z$ -table / Tableau des facteurs de correction**

$\varnothing$ $d_1$ [mm]	Korrekturfaktor / Correction factor / Facteur de correction		
	1	0,7	0,8
1	0,004	0,003	0,003
2	0,008	0,006	0,006
3	0,012	0,008	0,010
4	0,016	0,011	0,013
5	0,020	0,014	0,016
6	0,024	0,017	0,019
8	0,032	0,022	0,026

Für legierten Einsatzstahl gilt der Vorschubwert aus der Korrekturfaktor-Tabelle.  $K_f(f_z) = 1$  (entsprechend 100%)  $f_z = 0,024$

Für legierten Vergütungsstahl < 1300 N/mm<sup>2</sup> wird der Vorschubwert aus der Korrekturfaktor-Tabelle um 20% reduziert.

$K_f(f_z) = 0,8$  (entsprechend 80%)  $f_z = 0,019$

For case-hardening alloy steel the feed value from the table is valid:  $K_f(f_z) = 1$  (according to 100%)  $f_z = 0,024$

For heat treatable steel alloys < 1300 N/mm<sup>2</sup> the feed value from the table is reduced by 20%.

$K_f(f_z) = 0,8$  (according to 80%)  $f_z = 0,019$

La valeur d'avance du tableau des facteurs de correction est valable pour l'acier cémenté allié.

$K_f(f_z) = 1$  (correspondant à 100 %)  $f_z = 0,024$

La valeur d'avance du tableau des facteurs de correction est réduite de 20 % pour l'acier de traitement allié < 1 300 N/mm<sup>2</sup>.

$K_f(f_z) = 0,8$  (correspondant à 80 %)  $f_z = 0,019$

**Generelle Berechnungsformeln / General rule: / Formules de calcul générales :**

**Vorschub pro Zahn / Feed per tooth: / Avance par dent :** =  $f_z \cdot K_f(f_z)$

**Bohrvorschub (Fräsen in axialer Richtung):** = Tabellenwert / Zähnezahl

For axial plunge milling: = Table value / Number of teeth

Avance de perçage (fraisage dans le sens axial) : = valeur du tableau / nombre de dents

**Vorschub pro Zahn bei einer radialen Zustellung von 0,2 – 0,3 mm**

Feed per tooth with radial depth of cut from 0,2 – 0,3 mm

Avance par dent avec une disposition radiale de 0,2 – 0,3 mm

Ø d <sub>1</sub> [mm]	Korrekturfaktor / Correction factor / Facteur de correction									
	1	0,7	0,8	0,9	1,1	1,2	1,5	1,6	1,8	1,9
1	0,004	0,003	0,003	0,004	0,004	0,005	0,006	0,006	0,007	0,008
2	0,008	0,006	0,006	0,007	0,009	0,010	0,012	0,013	0,014	0,015
3	0,012	0,008	0,010	0,011	0,013	0,014	0,018	0,019	0,022	0,023
4	0,016	0,011	0,013	0,014	0,018	0,019	0,024	0,026	0,029	0,030
5	0,020	0,014	0,016	0,018	0,022	0,024	0,030	0,032	0,036	0,038
6	0,024	0,017	0,019	0,022	0,026	0,029	0,036	0,038	0,043	0,046
8	0,032	0,022	0,026	0,029	0,035	0,038	0,048	0,051	0,058	0,061
10	0,040	0,028	0,032	0,036	0,044	0,048	0,060	0,064	0,072	0,076
12	0,048	0,034	0,038	0,043	0,053	0,058	0,072	0,077	0,086	0,091
14	0,056	0,039	0,045	0,050	0,062	0,067	0,084	0,090	0,101	0,106
16	0,064	0,045	0,051	0,058	0,070	0,077	0,096	0,102	0,115	0,122
18	0,072	0,050	0,058	0,065	0,079	0,086	0,108	0,115	0,130	0,137
20	0,080	0,056	0,064	0,072	0,088	0,096	0,120	0,128	0,144	0,152
25	0,100	0,070	0,080	0,090	0,110	0,120	0,150	0,160	0,180	0,190

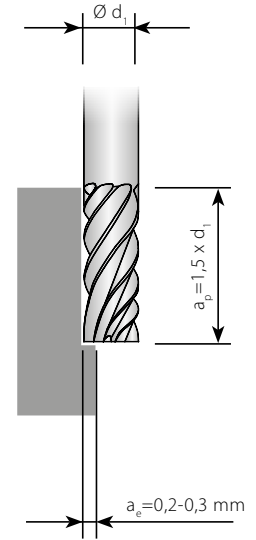

**Vorschub pro Zahn bei einer radialen Zustellung 10% vom Schneidendurchmesser (Ø d<sub>1</sub>)**

Feed per tooth with radial depth of cut of 10% of the cutter (Ø d<sub>1</sub>)

Avance par dent avec une disposition radiale de 10 % du diamètre de coupe (Ø d<sub>1</sub>)

Ø d <sub>1</sub> [mm]	Korrekturfaktor / Correction factor / Facteur de correction									
	1	0,7	0,8	0,9	1,1	1,2	1,5	1,6	1,8	1,9
1	0,003	0,002	0,002	0,003	0,003	0,004	0,005	0,005	0,005	0,006
2	0,008	0,006	0,006	0,007	0,009	0,010	0,012	0,013	0,014	0,015
3	0,012	0,008	0,010	0,011	0,013	0,014	0,018	0,019	0,022	0,023
4	0,014	0,010	0,011	0,013	0,015	0,017	0,021	0,022	0,025	0,027
5	0,017	0,012	0,014	0,015	0,019	0,020	0,026	0,027	0,031	0,032
6	0,020	0,014	0,016	0,018	0,022	0,024	0,030	0,032	0,036	0,038
8	0,027	0,019	0,022	0,024	0,030	0,032	0,041	0,043	0,049	0,051
10	0,033	0,023	0,026	0,030	0,036	0,040	0,050	0,053	0,059	0,063
12	0,040	0,028	0,032	0,036	0,044	0,048	0,060	0,064	0,072	0,076
14	0,047	0,033	0,038	0,042	0,052	0,056	0,071	0,075	0,085	0,089
16	0,053	0,037	0,042	0,048	0,058	0,064	0,080	0,085	0,095	0,101
18	0,060	0,042	0,048	0,054	0,066	0,072	0,090	0,096	0,108	0,114
20	0,067	0,047	0,054	0,060	0,074	0,080	0,101	0,107	0,121	0,127
25	0,083	0,058	0,066	0,075	0,091	0,100	0,125	0,133	0,149	0,158

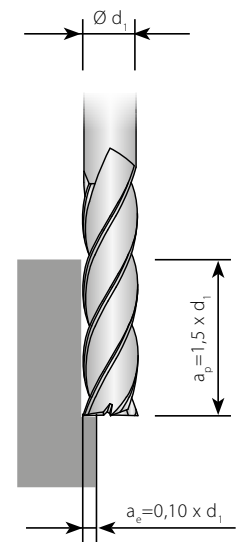

Achtung: Korrekturfaktor aus der Tabelle "Schnittgeschwindigkeiten" entnehmen.  
Korrekturfaktor -> 1,1 bei a<sub>p</sub> = 1 x d<sub>1</sub> -> 1,2 bei a<sub>p</sub> = 0,5 x d<sub>1</sub>

Attention: Take the correction factor from the table "Cutting speeds".  
Correction factor -> 1,1 with a<sub>p</sub> = 1 x d<sub>1</sub> -> 1,2 with a<sub>p</sub> = 0,5 x d<sub>1</sub>

Attention: Prenez le facteur de correction du tableau «Vitesses de coupe».  
Facteur de correction -> 1,1 pour a<sub>p</sub> = 1 x d<sub>1</sub> -> 1,2 pour a<sub>p</sub> = 0,5 x d<sub>1</sub>

## Vorschub pro Zahn bei einer radialen Zustellung 20% vom Schneidendurchmesser ( $\varnothing d_1$ )

Feed per tooth with radial depth of cut of 20% of the cutter ( $\varnothing d_1$ )

Avance par dent avec une disposition radiale de 20% du diamètre de coupe ( $\varnothing d_1$ )

$\varnothing d_1$ [mm]	Korrekturfaktor / Correction factor / Facteur de correction									
	1	0,7	0,8	0,9	1,1	1,2	1,5	1,6	1,8	1,9
1	0,002	0,001	0,001	0,001	0,002	0,002	0,003	0,003	0,003	0,003
2	0,005	0,003	0,004	0,004	0,005	0,006	0,007	0,008	0,009	0,009
3	0,008	0,005	0,006	0,007	0,008	0,009	0,012	0,012	0,014	0,015
4	0,010	0,007	0,008	0,009	0,011	0,012	0,015	0,016	0,018	0,019
5	0,013	0,009	0,010	0,011	0,014	0,015	0,019	0,020	0,023	0,024
6	0,015	0,010	0,012	0,013	0,016	0,018	0,022	0,024	0,027	0,028
8	0,020	0,014	0,016	0,018	0,022	0,024	0,030	0,032	0,036	0,038
10	0,025	0,017	0,020	0,022	0,027	0,030	0,037	0,040	0,045	0,047
12	0,030	0,021	0,024	0,027	0,033	0,036	0,045	0,048	0,054	0,057
14	0,035	0,024	0,028	0,031	0,038	0,042	0,052	0,056	0,063	0,066
16	0,040	0,028	0,032	0,036	0,044	0,048	0,060	0,064	0,072	0,076
18	0,045	0,031	0,036	0,040	0,049	0,054	0,067	0,072	0,081	0,085
20	0,050	0,035	0,040	0,045	0,055	0,060	0,075	0,080	0,090	0,095
25	0,063	0,044	0,050	0,056	0,069	0,075	0,094	0,100	0,113	0,119

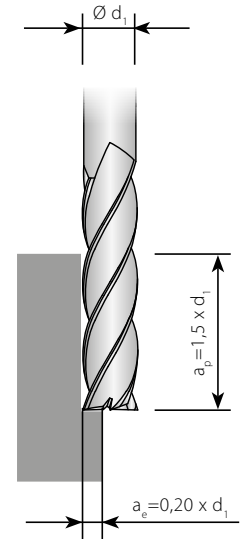

## Vorschub pro Zahn bei einer radialen Zustellung 40% vom Schneidendurchmesser ( $\varnothing d_1$ )

Feed per tooth with radial depth of cut of 40% of the cutter ( $\varnothing d_1$ )

Avance par dent avec une disposition radiale de 40% du diamètre de coupe ( $\varnothing d_1$ )

$\varnothing d_1$ [mm]	Korrekturfaktor / Correction factor / Facteur de correction									
	1	0,7	0,8	0,9	1,1	1,2	1,5	1,6	1,8	1,9
1	0,001	0,001	0,001	0,001	0,001	0,001	0,002	0,002	0,002	0,003
2	0,004	0,002	0,003	0,003	0,004	0,004	0,006	0,006	0,007	0,007
3	0,006	0,004	0,005	0,005	0,007	0,007	0,009	0,010	0,011	0,012
4	0,008	0,005	0,006	0,007	0,008	0,009	0,012	0,012	0,014	0,015
5	0,010	0,007	0,008	0,009	0,011	0,012	0,015	0,016	0,018	0,019
6	0,012	0,008	0,009	0,010	0,013	0,014	0,018	0,019	0,021	0,022
8	0,016	0,011	0,012	0,014	0,017	0,019	0,024	0,025	0,028	0,030
10	0,020	0,014	0,016	0,018	0,022	0,024	0,030	0,032	0,036	0,038
12	0,024	0,016	0,019	0,021	0,026	0,028	0,036	0,038	0,043	0,045
14	0,028	0,019	0,022	0,025	0,030	0,033	0,042	0,044	0,050	0,053
16	0,032	0,022	0,025	0,028	0,035	0,038	0,048	0,051	0,057	0,060
18	0,036	0,025	0,028	0,032	0,039	0,043	0,054	0,057	0,064	0,068
20	0,040	0,028	0,032	0,036	0,044	0,048	0,060	0,064	0,072	0,076
25	0,050	0,035	0,040	0,045	0,055	0,060	0,075	0,080	0,090	0,095

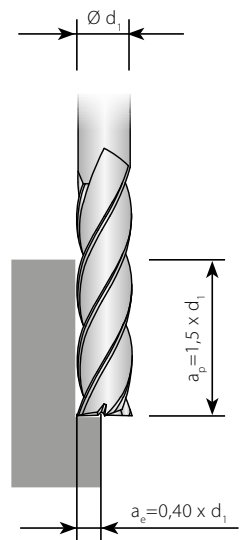

**Achtung:** Korrekturfaktor aus der Tabelle "Schnittgeschwindigkeiten" entnehmen.  
Korrekturfaktor -> 1,1 bei  $a_p = 1 \times d_1$  -> 1,2 bei  $a_p = 0,5 \times d_1$

Attention: Take the correction factor from the table "Cutting speeds".  
Correction factor -> 1,1 with  $a_p = 1 \times d_1$  -> 1,2 with  $a_p = 0,5 \times d_1$

Attention: Prenez le facteur de correction du tableau «Vitesse de coupe».  
Facteur de correction -> 1,1 pour  $a_p = 1 \times d_1$  -> 1,2 pour  $a_p = 0,5 \times d_1$

## Vorschub pro Zahn bei einer radialen Zustellung 60% vom Schneidendurchmesser ( $\varnothing d_1$ )

Feed per tooth with radial depth of cut of 60% of the cutter ( $\varnothing d_1$ )

Avance par dent avec une disposition radiale de 60% du diamètre de coupe ( $\varnothing d_1$ )

$\varnothing d_1$ [mm]	Korrekturfaktor / Correction factor / Facteur de correction									
	1	0,7	0,8	0,9	1,1	1,2	1,5	1,6	1,8	1,9
1	0,001	0,001	0,001	0,001	0,001	0,001	0,001	0,002	0,002	0,002
2	0,003	0,002	0,002	0,002	0,003	0,003	0,004	0,005	0,005	0,006
3	0,005	0,003	0,004	0,004	0,005	0,006	0,007	0,008	0,009	0,009
4	0,006	0,004	0,005	0,005	0,007	0,007	0,009	0,010	0,011	0,012
5	0,008	0,005	0,006	0,007	0,009	0,010	0,012	0,013	0,015	0,016
6	0,009	0,006	0,007	0,008	0,010	0,011	0,014	0,015	0,017	0,018
8	0,013	0,009	0,010	0,011	0,014	0,015	0,019	0,020	0,023	0,024
10	0,016	0,011	0,013	0,014	0,017	0,019	0,024	0,026	0,029	0,030
12	0,019	0,013	0,015	0,017	0,021	0,023	0,029	0,031	0,035	0,037
14	0,022	0,015	0,018	0,020	0,025	0,027	0,034	0,036	0,040	0,043
16	0,026	0,018	0,020	0,023	0,028	0,031	0,039	0,041	0,046	0,049
18	0,029	0,020	0,023	0,026	0,032	0,035	0,043	0,046	0,052	0,055
20	0,032	0,022	0,026	0,029	0,035	0,039	0,048	0,052	0,058	0,061
25	0,040	0,028	0,032	0,036	0,045	0,049	0,061	0,065	0,073	0,077

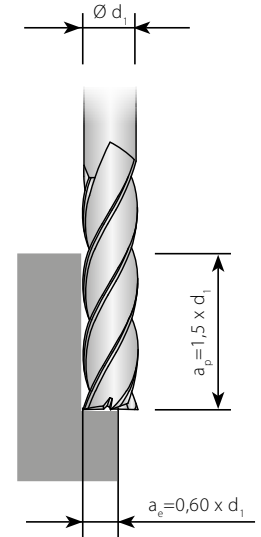

## Vorschub pro Zahn bei einer radialen Zustellung 80% vom Schneidendurchmesser ( $\varnothing d_1$ )

Feed per tooth with radial depth of cut of 80% of the cutter ( $\varnothing d_1$ )

Avance par dent avec une disposition radiale de 80% du diamètre de coupe ( $\varnothing d_1$ )

$\varnothing d_1$ [mm]	Korrekturfaktor / Correction factor / Facteur de correction									
	1	0,7	0,8	0,9	1,1	1,2	1,5	1,6	1,8	1,9
1	0,001	0,001	0,001	0,001	0,001	0,001	0,001	0,001	0,001	0,001
2	0,002	0,001	0,002	0,002	0,002	0,003	0,003	0,004	0,004	0,004
3	0,004	0,002	0,003	0,003	0,004	0,004	0,006	0,006	0,007	0,007
4	0,005	0,003	0,004	0,004	0,005	0,006	0,007	0,008	0,009	0,009
5	0,006	0,004	0,005	0,005	0,007	0,007	0,009	0,010	0,011	0,012
6	0,007	0,005	0,006	0,006	0,008	0,009	0,011	0,012	0,013	0,014
8	0,010	0,007	0,008	0,009	0,011	0,012	0,015	0,016	0,018	0,019
10	0,012	0,008	0,010	0,011	0,013	0,015	0,018	0,020	0,022	0,023
12	0,015	0,010	0,012	0,013	0,016	0,018	0,022	0,024	0,027	0,028
14	0,017	0,012	0,014	0,015	0,019	0,021	0,026	0,028	0,031	0,033
16	0,020	0,014	0,016	0,018	0,022	0,024	0,030	0,032	0,036	0,038
18	0,022	0,015	0,018	0,020	0,024	0,027	0,033	0,036	0,040	0,042
20	0,025	0,017	0,020	0,022	0,027	0,030	0,037	0,040	0,045	0,047
25	0,031	0,022	0,025	0,028	0,034	0,037	0,047	0,050	0,056	0,059

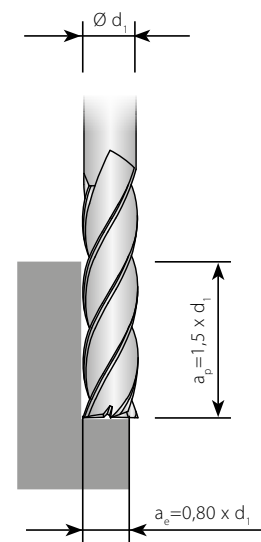

**Achtung:** Korrekturfaktor aus der Tabelle "Schnittgeschwindigkeiten" entnehmen.  
Korrekturfaktor -> 1,1 bei  $a_p = 1 \times d_1$  -> 1,2 bei  $a_p = 0,5 \times d_1$

Attention: Take the correction factor from the table "Cutting speeds".  
Correction factor -> 1,1 with  $a_p = 1 \times d_1$  -> 1,2 with  $a_p = 0,5 \times d_1$

Attention: Prenez le facteur de correction du tableau «Vitesse de coupe».  
Facteur de correction -> 1,1 pour  $a_p = 1 \times d_1$  -> 1,2 pour  $a_p = 0,5 \times d_1$



Recommended cutting data feed tables

Tableaux des avances valeurs de coupe recommandées

**Vorschub pro Zahn beim Vollnutfräsen →  $a_p = 0,5 \times d_1$**

Feed per tooth when full slot milling →  $a_p = 0,5 \times d_1$

Avance par dent pour le rainurage →  $a_p = 0,5 \times d_1$

Ø d <sub>1</sub> [mm]	Korrekturfaktor / Correction factor									
	1	0,7	0,8	0,9	1,1	1,2	1,5	1,6	1,8	1,9
1	0,002	0,001	0,001	0,001	0,002	0,002	0,003	0,003	0,003	0,003
2	0,004	0,002	0,003	0,003	0,004	0,004	0,006	0,006	0,007	0,007
3	0,007	0,004	0,005	0,006	0,007	0,008	0,010	0,011	0,012	0,013
4	0,009	0,006	0,007	0,008	0,009	0,010	0,013	0,014	0,016	0,017
5	0,011	0,007	0,008	0,009	0,012	0,013	0,016	0,017	0,019	0,020
6	0,013	0,009	0,010	0,011	0,014	0,015	0,019	0,020	0,023	0,024
8	0,018	0,012	0,014	0,016	0,019	0,021	0,027	0,028	0,032	0,034
10	0,022	0,015	0,017	0,019	0,024	0,026	0,033	0,035	0,039	0,041
12	0,030	0,021	0,024	0,027	0,033	0,036	0,045	0,048	0,054	0,057
14	0,032	0,022	0,025	0,028	0,035	0,038	0,048	0,051	0,057	0,060
16	0,036	0,025	0,028	0,032	0,039	0,043	0,054	0,057	0,064	0,068
18	0,042	0,029	0,033	0,037	0,046	0,050	0,063	0,067	0,075	0,079
20	0,045	0,031	0,036	0,040	0,049	0,054	0,067	0,072	0,081	0,085
25	0,056	0,039	0,044	0,050	0,061	0,067	0,084	0,089	0,100	0,106

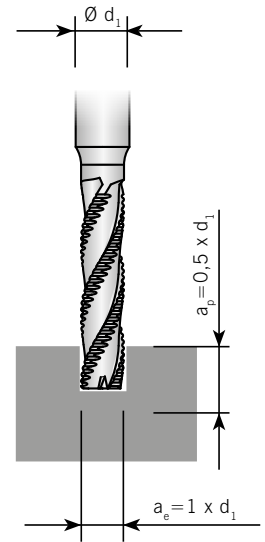

AFA

**Vorschub pro Zahn beim Vollnutfräsen →  $a_p = 1 \times d_1$**

Feed per tooth when full slot milling →  $a_p = 1 \times d_1$

Avance par dent pour le rainurage →  $a_p = 1 \times d_1$

Ø d <sub>1</sub> [mm]	Korrekturfaktor / Correction factor									
	1	0,7	0,8	0,9	1,1	1,2	1,5	1,6	1,8	1,9
1	0,001	0,001	0,001	0,001	0,001	0,002	0,002	0,002	0,002	0,002
2	0,003	0,002	0,002	0,002	0,003	0,003	0,004	0,004	0,005	0,005
3	0,005	0,003	0,004	0,004	0,005	0,005	0,007	0,007	0,008	0,009
4	0,006	0,004	0,005	0,005	0,006	0,007	0,009	0,009	0,011	0,011
5	0,007	0,005	0,006	0,006	0,008	0,009	0,011	0,011	0,013	0,014
6	0,008	0,006	0,007	0,008	0,009	0,010	0,013	0,014	0,015	0,016
8	0,012	0,008	0,009	0,011	0,013	0,014	0,018	0,019	0,021	0,022
10	0,014	0,010	0,011	0,013	0,016	0,017	0,021	0,023	0,026	0,027
12	0,020	0,014	0,016	0,018	0,021	0,023	0,029	0,031	0,035	0,037
14	0,021	0,015	0,017	0,019	0,023	0,025	0,031	0,033	0,037	0,040
16	0,023	0,016	0,019	0,021	0,026	0,028	0,035	0,037	0,042	0,044
18	0,027	0,019	0,022	0,025	0,030	0,033	0,041	0,044	0,049	0,052
20	0,029	0,020	0,023	0,026	0,032	0,035	0,044	0,047	0,053	0,056
25	0,036	0,025	0,029	0,033	0,040	0,044	0,055	0,058	0,066	0,069

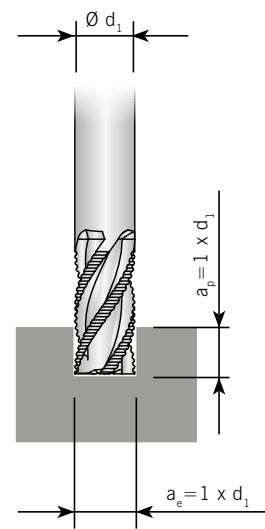

**Achtung:** Für unbeschichtete Werkzeuge ist der Vorschub um 10-20% zu reduzieren.

Attention: Feed rates are reduced by 10-20% for uncoated tools.

Attention: Pour les outils sans revêtement, l'avance doit être réduite de 10 à 20 %.

Vorschübe für Vollradius- und Torusfräser

Feed rates for ball nosed- and High feed cutters

Avances pour les fraises à rayon complet et toriques

AFA

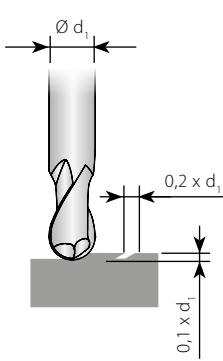
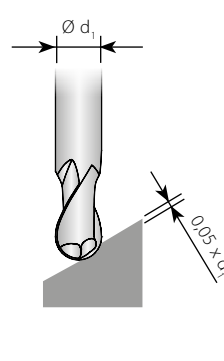
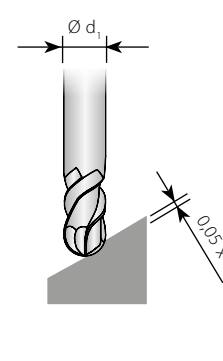
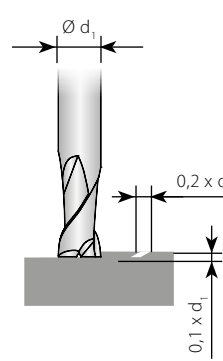
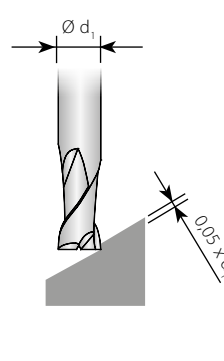
	<b>Radiusfräser</b> Ball nose end milling cutters Fraise à rayon	<b>Radiusfräser</b> Ball nose end milling cutters Fraise à rayon	<b>Formenbau-Radiusfräser</b> Ball nose cutter for mold and die production <b>Fraise à rayon</b> pour la fabrication de moules	<b>Torusfräser</b> Torus end milling cutters Fraise torique	<b>Torusfräser</b> Torus end milling cutters Fraise torique
					
$d_1$ [mm]	fz [mm]	fz [mm]	fz [mm]	fz [mm]	fz [mm]
2	0,015	0,010	0,005	0,010	0,015
3	0,030	0,020	0,015	0,015	0,020
4	0,040	0,030	0,030	0,020	0,030
5	0,060	0,050	0,050	0,030	0,040
6	0,070	0,060	0,060	0,050	0,060
8	0,100	0,080	0,070	0,070	0,080
10	0,120	0,100	0,080	0,080	0,100
12	0,150	0,120	0,090	0,100	0,120
16	0,180	0,150	0,100	0,120	0,150
18	0,200	0,180	0,110	0,140	0,160
20	0,220	0,200	0,120	0,150	0,180
25	0,240	0,220	0,140	0,160	0,200

# ARNO®

## WERKZEUGE

We have a passion for precision.

# AUSFÜHRUNG AFD

*Design AFD / Modèle AFD*

**D100 = speziell für die Grafitbearbeitung**

*D100 = especially for graphite machining*

*D100 = spécialement développée pour l'usinage  
du graphite*

Die hohe Härte der Beschichtung macht die ARNO® AFD Fräser besonders verschleißfest und verbessert die Standzeit. Die ultrafeine Diamantbeschichtung überzeugt durch eine optimale Oberflächengüte und hohe Leistungsfähigkeit.



*The hard coating ensures excellent wear resistance and long tool life, the ultra-fine diamond coating leaves an outstanding surface finish.*

La dureté élevée du revêtement rend les fraises AFD ARNO® particulièrement résistantes à l'usure et améliore leur durée de vie. Le revêtement diamant ultra fin permet d'obtenir d'excellents états de surface et des performances élevées.

Solid carbide end-mill

Fraise carbure monobloc à tige

## AFD50724-...R...

2 Schneiden, Mini-Ausführung, mit Eckenradius / 2 flutes, mini design, with corner radius / 2 dents, version mini, avec rayon d'angle

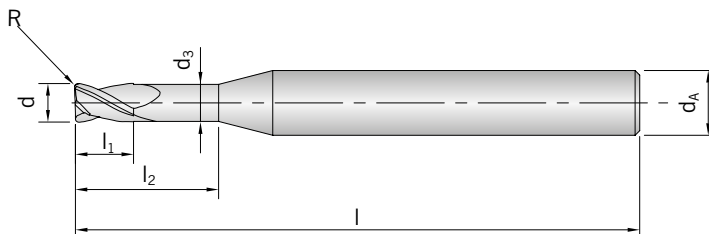
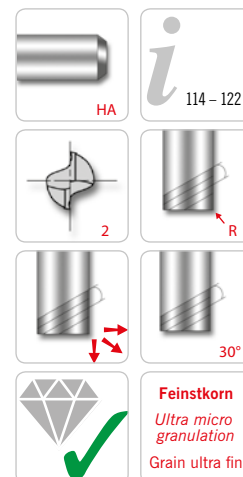

nur für die Bearbeitung von Graphit / only for for graphite machining / et pour seulement usinage de graphite

									PG 24
									beschichtet coated revêtu
Schaft DIN 6535HA Shank Tige	d -0,02	d <sub>A</sub> h6	d <sub>3</sub>	l <sub>1</sub>	l <sub>2</sub>	l	R	D100	
AFD50724-002A	0,2	3	-	0,3	-	40	-	●	
AFD50724-003A	0,3	3	-	0,5	-	40	-	●	
AFD50724-004A	0,4	3	-	0,6	-	40	-	●	
AFD50724-005AR0,05	0,5	3	0,45	0,7	2,5	40	0,05	●	
AFD50724-005BR0,05	0,5	3	0,45	0,7	4,0	40	0,05	●	
AFD50724-006AR0,05	0,6	3	0,55	0,9	3,0	40	0,05	●	
AFD50724-006BR0,05	0,6	3	0,55	0,9	5,0	40	0,05	●	
AFD50724-008AR0,05	0,8	3	0,75	1,2	4,0	40	0,05	●	
AFD50724-008BR0,05	0,8	3	0,75	1,2	7,0	40	0,05	●	
AFD50724-010AR0,1	1,0	3	0,95	1,5	5,0	40	0,10	●	
AFD50724-010BR0,1	1,0	3	0,95	1,5	8,5	40	0,10	●	
AFD50724-010CR0,1	1,0	3	0,95	1,5	12,0	40	0,10	●	
AFD50724-012AR0,1	1,2	3	1,15	1,8	6,0	50	0,10	●	
AFD50724-012BR0,1	1,2	3	1,15	1,8	10,0	50	0,10	●	
AFD50724-015AR0,15	1,5	3	1,40	2,2	7,5	50	0,15	●	
AFD50724-015BR0,15	1,5	3	1,40	2,2	12,0	50	0,15	●	
AFD50724-015CR0,15	1,5	3	1,40	2,2	18,0	50	0,15	●	
AFD50724-020AR0,15	2,0	3	1,90	2,2	10,0	60	0,15	●	
AFD50724-020BR0,15	2,0	3	1,90	2,2	16,0	60	0,15	●	
AFD50724-020CR0,15	2,0	3	1,90	2,2	25,0	60	0,15	●	
AFD50724-030AR0,2	3,0	4	2,90	3,0	10,0	65	0,20	●	
AFD50724-030BR0,2	3,0	4	2,90	3,0	15,0	65	0,20	●	
AFD50724-030CR0,2	3,0	4	2,90	3,0	20,0	65	0,20	●	
AFD50724-030DR0,2	3,0	4	2,90	3,0	25,0	75	0,20	●	
AFD50724-030ER0,2	3,0	4	2,90	3,0	30,0	75	0,20	●	
AFD50724-040AR0,2	4,0	6	3,90	4,0	20,0	65	0,20	●	
AFD50724-040BR0,2	4,0	6	3,90	4,0	30,0	75	0,20	●	
AFD50724-040CR0,2	4,0	6	3,90	4,0	40,0	90	0,20	●	
AFD50724-050AR0,3	5,0	6	4,90	5,0	20,0	75	0,30	●	
AFD50724-050BR0,3	5,0	6	4,90	5,0	30,0	75	0,30	●	
AFD50724-050CR0,3	5,0	6	4,90	5,0	40,0	90	0,30	●	
AFD50724-050DR0,3	5,0	6	4,90	5,0	50,0	90	0,30	●	

Solid carbide end-mill

Fraise carbure monobloc à tige

									PG 24
									beschichtet coated revêtu
Schaft DIN 6535HA Shank Tige	d -0,02	d <sub>A</sub> h6	d <sub>3</sub>	l <sub>1</sub>	l <sub>2</sub>	l	R	D100	
AFD50724-060AR0,3	6,0	6	5,90	6,0	30,0	75	0,30	●	
AFD50724-060BR0,3	6,0	6	5,90	6,0	40,0	90	0,30	●	
AFD50724-060CR0,3	6,0	6	5,90	6,0	50,0	90	0,30	●	
AFD50724-060DR0,3	6,0	6	5,90	6,0	60,0	100	0,30	●	

P	
M	
K	
N	●
S	
H	

- **Hauptanwendung**  
Main application  
Application principale
- **Nebenanwendung**  
Secondary application  
Application secondaire

Solid carbide end-mill  
Fraise carbure monobloc à tige

## AFD50121-...

2 Schneiden, lange Ausführung / 2 flutes, long design / 2 dents, version longue

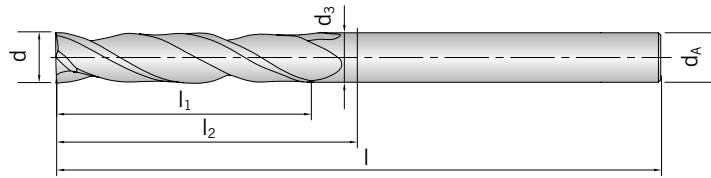

nur für die Bearbeitung von Graphit / only for for graphite machining / et pour seulement usinage de graphite

							PG 24
							beschichtet coated revêtu
Schaft DIN 6535HA Shank Tige	d -0,03	d <sub>A</sub> h6	d <sub>3</sub>	l <sub>1</sub>	l <sub>2</sub>	l	D100
AFD50121-005	0,5	3	0,45	1	2	40	●
AFD50121-006	0,6	3	0,55	2	3	40	●
AFD50121-007	0,7	3	0,65	2	4	40	●
AFD50121-008	0,8	3	0,75	2	5	40	●
AFD50121-009	0,9	3	0,85	2	6	40	●
AFD50121-010	1,0	4	0,95	3	8	75	●
AFD50121-015	1,5	4	1,45	4	10	75	●
AFD50121-020	2,0	4	1,90	6	16	100	●
AFD50121-025	2,5	4	2,40	8	20	100	●
AFD50121-030	3,0	6	2,80	8	30	100	●
AFD50121-035	3,5	6	3,20	10	35	100	●
AFD50121-040	4,0	6	3,70	20	40	100	●
AFD50121-050	5,0	6	4,60	25	50	125	●
AFD50121-060	6,0	6	5,60	30	60	140	●
AFD50121-070	7,0	6	-	35	-	140	●
AFD50121-080	8,0	8	7,40	40	80	150	●
AFD50121-090	9,0	8	-	45	-	150	●
AFD50121-100	10,0	10	9,40	50	80	150	●
AFD50121-110	11,0	10	-	50	-	150	●
AFD50121-120	12,0	12	11,40	55	80	150	●

P	
M	
K	
N	●
S	
H	

● Hauptanwendung  
Main application  
Application principale  
○ Nebenanwendung  
Secondary application  
Application secondaire

Solid carbide ball-nose end-mill  
Fraise carbure monobloc hémisphérique

## AFD51824-...

2 Schneiden, Mini-Ausführung / 2 flutes, mini design / 2 dents, version mini

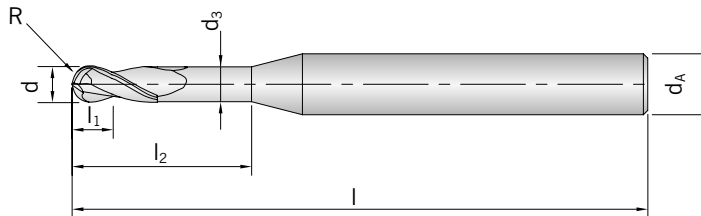

nur für die Bearbeitung von Graphit / only for for graphite machining / et pour seulement usinage de graphite

									PG 24
									beschichtet coated revêtu
Schaft DIN 6535HA Shank Tige	d -0,02	d <sub>A</sub> h6	d <sub>3</sub>	l <sub>1</sub>	l <sub>2</sub>	l	R ± 0,01	D100	
AFD51824-002A	0,2	3	-	0,2	-	40	0,10	●	
AFD51824-003A	0,3	3	-	0,3	-	40	0,15	●	
AFD51824-004A	0,4	3	-	0,4	-	40	0,20	●	
AFD51824-005A	0,5	3	0,45	0,5	2,5	40	0,25	●	
AFD51824-006A	0,6	3	0,55	0,6	3,0	40	0,30	●	
AFD51824-006B	0,6	3	0,55	0,6	5,0	40	0,30	●	
AFD51824-008A	0,8	3	0,75	0,8	4,0	40	0,40	●	
AFD51824-008B	0,8	3	0,75	0,8	7,0	40	0,40	●	
AFD51824-010A	1,0	3	0,95	1,0	5,0	40	0,50	●	
AFD51824-010B	1,0	3	0,95	1,0	8,5	40	0,50	●	
AFD51824-010C	1,0	3	0,95	1,0	12,0	40	0,50	●	
AFD51824-012A	1,2	3	1,15	1,2	6,0	50	0,60	●	
AFD51824-012B	1,2	3	1,15	1,2	10,0	50	0,60	●	
AFD51824-015A	1,5	3	1,40	1,5	7,5	50	0,75	●	
AFD51824-015B	1,5	3	1,40	1,5	12,0	50	0,75	●	
AFD51824-015C	1,5	3	1,40	1,5	18,0	50	0,75	●	
AFD51824-020A	2,0	3	1,90	2,2	10,0	60	1,00	●	
AFD51824-020B	2,0	3	1,90	2,2	16,0	60	1,00	●	
AFD51824-020C	2,0	3	1,90	2,2	25,0	60	1,00	●	
AFD51824-030A	3,0	4	2,90	3,0	10,0	65	1,50	●	
AFD51824-030B	3,0	4	2,90	3,0	15,0	65	1,50	●	
AFD51824-030C	3,0	4	2,90	3,0	20,0	65	1,50	●	
AFD51824-030D	3,0	4	2,90	3,0	25,0	75	1,50	●	
AFD51824-030E	3,0	4	2,90	3,0	30,0	75	1,50	●	
AFD51824-040A	4,0	6	3,90	4,0	20,0	65	2,00	●	
AFD51824-040B	4,0	6	3,90	4,0	30,0	75	2,00	●	
AFD51824-040C	4,0	6	3,90	4,0	40,0	90	2,00	●	
AFD51824-050A	5,0	6	4,90	5,0	20,0	65	2,50	●	
AFD51824-050B	5,0	6	4,90	5,0	30,0	75	2,50	●	
AFD51824-050C	5,0	6	4,90	5,0	40,0	90	2,50	●	
AFD51824-050D	5,0	6	4,90	5,0	50,0	90	2,50	●	
AFD51824-060A	6,0	6	5,90	6,0	30,0	75	3,00	●	

Solid carbide ball-nose end-mill  
 Fraise carbure monobloc hémisphérique

PG 24

beschichtet  
 coated  
 revêtu

Schaft DIN 6535HA

Shank  
 Tige

	d -0,02	d <sub>A</sub> h6	d <sub>3</sub>	l <sub>1</sub>	l <sub>2</sub>	l	R ± 0,01	D100
AFD51824-060B	6,0	6	5,90	6,0	40,0	90	3,00	●
AFD51824-060C	6,0	6	5,90	6,0	50,0	90	3,00	●
AFD51824-060D	6,0	6	5,90	6,0	60,0	100	3,00	●

P	
M	
K	
N	●
S	
H	

● **Hauptanwendung**  
 Main application  
 Application principale

○ **Nebenanwendung**  
 Secondary application  
 Application secondaire



Solid carbide end-mill  
Fraise carbure monobloc à tige

## AFD54030-...R...

3 Schneiden, kurze Ausführung, mit Eckenradius / 3 flutes, short design, with corner radius / 3 dents, version courte avec rayon d'angle

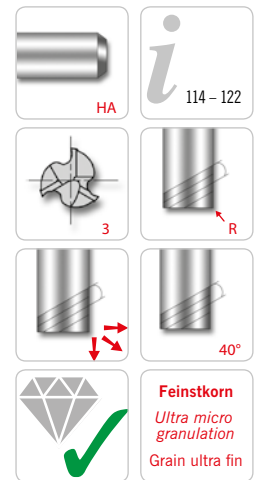
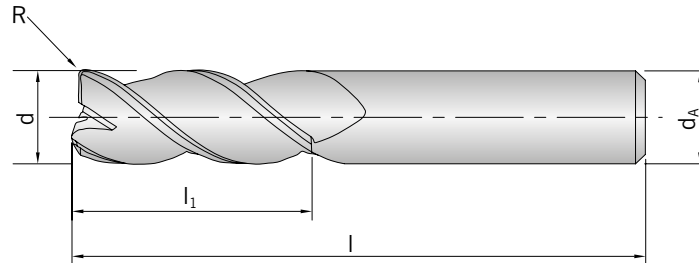

AFD

nur für die Bearbeitung von Graphit / only for for graphite machining / et pour seulement usinage de graphite

							PG 24
							beschichtet coated revêtu
Schaft DIN 6535HA Shank Tige	d -0,03	d <sub>A</sub> h6	l <sub>1</sub>	l	R	D100	
AFD54030-020R0,15	2	3	6	40	0,15	●	
AFD54030-030R0,15	3	3	12	40	0,15	●	
AFD54030-040R0,2	4	4	14	50	0,20	●	
AFD54030-050R0,3	5	5	16	50	0,30	●	
AFD54030-060R0,3	6	6	20	65	0,30	●	
AFD54030-080R0,5	8	8	20	65	0,50	●	
AFD54030-100R0,5	10	10	25	75	0,50	●	
AFD54030-120R0,5	12	12	25	75	0,50	●	

P	
M	
K	
N	●
S	
H	

● Hauptanwendung  
Main application  
Application principale

○ Nebenanwendung  
Secondary application  
Application secondaire

# Empfohlene Schnittwerte Vorschubtabellen

Recommended cutting data feed tables

Tableaux des avances valeurs de coupe recommandées

## AFD50724-...

### D100-Beschichtung für Graphitbearbeitung

D100 coating for graphite machining

D100 revêtement pour l'usinage du graphite

$\varnothing d_1$ [mm]	Z	fz [mm]	n 15000 min1 vf [mm/min.]	n 25000 min1 vf [mm/min.]	n 30000 min1 vf [mm/min.]	n 45000 min1 vf [mm/min.]
0,2	2	0,004	120	200	240	360
0,3	2	0,005	150	250	300	450
0,4	2	0,005	150	250	300	450
0,5	2	0,006	180	300	360	540
0,6	2	0,007	210	350	420	630
0,8	2	0,009	270	450	540	810
1,0	2	0,012	360	600	720	1080
1,2	2	0,015	450	750	900	1350
1,5	2	0,018	540	900	1080	1620
2,0	2	0,024	720	1200	1440	2160
3,0	2	0,035	1050	1750	2100	3150
4,0	2	0,047	1410	2350	2820	4230
5,0	2	0,059	1770	2950	3540	5310
6,0	2	0,071	2130	3550	4260	6390

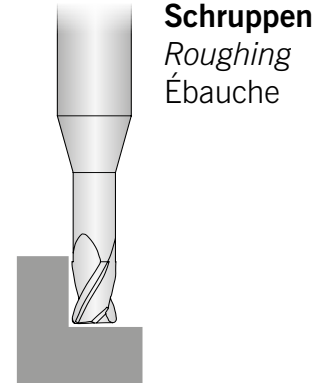

$\varnothing d_1$ [mm]	Z	fz [mm]	n 15000 min1 vf [mm/min.]	n 25000 min1 vf [mm/min.]	n 30000 min1 vf [mm/min.]	n 45000 min1 vf [mm/min.]
0,2	2	0,004	120	200	240	360
0,3	2	0,004	120	200	240	360
0,4	2	0,004	120	200	240	360
0,5	2	0,005	150	250	300	450
0,6	2	0,005	150	250	300	450
0,8	2	0,007	210	350	420	630
1,0	2	0,009	270	450	540	810
1,2	2	0,011	330	550	660	990
1,5	2	0,014	420	700	840	1260
2,0	2	0,018	540	900	1080	1620
3,0	2	0,027	810	1350	1620	2430
4,0	2	0,036	1080	1800	2160	3240
5,0	2	0,045	1350	2250	2700	4050
6,0	2	0,055	1650	2750	3300	4950

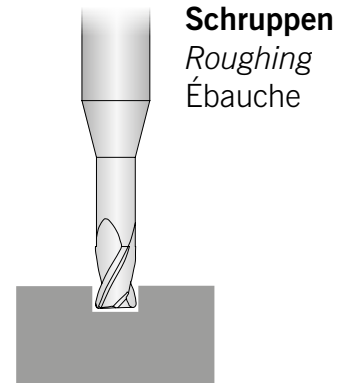

**Achtung:** Die angegebenen Schnittparameter sind Richt- und Startwerte.  
Kundenspezifische Gegebenheiten wie Antriebsleistung, Maschinenstabilität, Werkzeugauskragung etc. sind hierbei nicht berücksichtigt.

Attention: These cutting data are recommendations only.  
Customer specific circumstances such as machine power, stability, tool overhang etc. are not taken into consideration.

Attention: Les paramètres de coupe indiqués sont des valeurs indicatives et initiales.  
Les situations spécifiques au client, telles que la puissance motrice, la stabilité de la machine, le porte-à-faux de l'outil, etc. ne sont ici pas prises en compte.

# Empfohlene Schnittwerte Vorschubtabellen

Recommended cutting data feed tables

Tableaux des avances valeurs de coupe recommandées

## AFD50724-...

### D100-Beschichtung für Graphitbearbeitung

D100 coating for graphite machining

D100 revêtement pour l'usinage du graphite

$\varnothing d_1$ [mm]	Z	fz [mm]	n 15000 min1 vf [mm/min.]	n 25000 min1 vf [mm/min.]	n 30000 min1 vf [mm/min.]	n 45000 min1 vf [mm/min.]
0,2	2	0,004	120	200	240	360
0,3	2	0,004	120	200	240	360
0,4	2	0,005	150	250	300	450
0,5	2	0,007	210	350	420	630
0,6	2	0,008	240	400	480	720
0,8	2	0,011	330	550	660	990
1,0	2	0,013	390	650	780	1170
1,2	2	0,015	450	750	900	1350
1,5	2	0,020	600	1000	1200	1800
2,0	2	0,027	810	1350	1620	2430
3,0	2	0,040	1200	2000	2400	3600
4,0	2	0,053	1590	2650	3180	4770
5,0	2	0,067	2010	3350	4020	6030
6,0	2	0,080	2400	4000	4800	7200

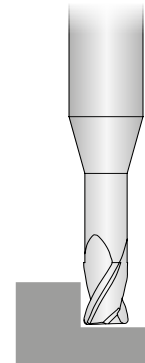

Schlichten  
Finishing  
Finition

AFD

$\varnothing d_1$ [mm]	Z	fz [mm]	n 15000 min1 vf [mm/min.]	n 25000 min1 vf [mm/min.]	n 30000 min1 vf [mm/min.]	n 45000 min1 vf [mm/min.]
0,2	2	0,004	120	200	240	360
0,3	2	0,004	120	200	240	360
0,4	2	0,005	150	250	300	450
0,5	2	0,007	210	350	420	630
0,6	2	0,008	240	400	480	720
0,8	2	0,011	330	550	660	990
1,0	2	0,013	390	650	780	1170
1,2	2	0,015	450	750	900	1350
1,5	2	0,020	600	1000	1200	1800
2,0	2	0,027	810	1350	1620	2430
3,0	2	0,040	1200	2000	2400	3600
4,0	2	0,053	1590	2650	3180	4770
5,0	2	0,067	2010	3350	4020	6030
6,0	2	0,080	2400	4000	4800	7200

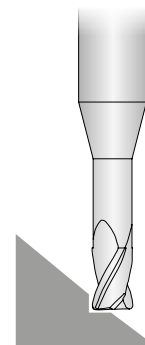

Schlichten  
Finishing  
Finition

**Achtung:** Die angegebenen Schnittparameter sind Richt- und Startwerte.

Kundenspezifische Gegebenheiten wie Antriebsleistung, Maschinenstabilität, Werkzeugauskragung etc. sind hierbei nicht berücksichtigt.

Attention: These cutting data are recommendations only.

Customer specific circumstances such as machine power, stability, tool overhang etc. are not taken into consideration.

Attention: Les paramètres de coupe indiqués sont des valeurs indicatives et initiales.

Les situations spécifiques au client, telles que la puissance motrice, la stabilité de la machine, le porte-à-faux de l'outil, etc. ne sont ici pas prises en compte.

# Empfohlene Schnittwerte Vorschubtabellen

Recommended cutting data feed tables

Tableaux des avances valeurs de coupe recommandées

## AFD50121-...

### D100-Beschichtung für Graphitbearbeitung

D100 coating for graphite machining

D100 revêtement pour l'usinage du graphite

Ø d <sub>1</sub> [mm]	Z	fz [mm]	n 15000 min1 vf [mm/min.]	n 25000 min1 vf [mm/min.]	n 30000 min1 vf [mm/min.]	n 45000 min1 vf [mm/min.]
0,5	2	0,005	150	250	300	450
0,6	2	0,006	180	300	360	540
0,7	2	0,007	210	350	420	630
0,8	2	0,008	240	400	480	720
0,9	2	0,008	240	400	480	720
1,0	2	0,009	270	450	540	810
1,5	2	0,014	420	700	840	1260
2,0	2	0,019	570	950	1140	1710
2,5	2	0,024	720	1200	1440	2160
3,0	2	0,029	840	1400	1680	2520
3,5	2	0,032	960	1600	1920	2880
4,0	2	0,040	1200	2000	2400	3600
5,0	2	0,045	1350	2250	2700	4050
6,0	2	0,050	1500	2500	3000	4500
7,0	2	0,055	1650	2750	3300	4950
8,0	2	0,060	1800	3000	3600	5400
9,0	2	0,065	1950	3250	3900	5850
10,0	2	0,070	2100	3500	4200	6300
11,0	2	0,075	2250	3750	4500	6750
12,0	2	0,080	2400	4000	4800	7200



**Schruppen**  
Roughing  
Ébauche

Ø d <sub>1</sub> [mm]	Z	fz [mm]	n 15000 min1 vf [mm/min.]	n 25000 min1 vf [mm/min.]	n 30000 min1 vf [mm/min.]	n 45000 min1 vf [mm/min.]
0,5	2	0,003	90	150	180	270
0,6	2	0,003	90	150	180	270
0,7	2	0,003	90	150	180	270
0,8	2	0,004	120	200	240	360
0,9	2	0,005	150	250	300	450
1,0	2	0,005	150	250	300	450
1,5	2	0,008	240	400	480	720
2,0	2	0,011	330	550	660	990
2,5	2	0,014	420	700	840	1260
3,0	2	0,016	480	800	960	1440
3,5	2	0,019	570	950	1140	1710
4,0	2	0,021	630	1050	1260	1890
5,0	2	0,026	780	1300	1560	2340
6,0	2	0,031	930	1550	1860	2790
7,0	2	0,036	1080	1800	2160	3240
8,0	2	0,040	1200	2000	2400	3600
9,0	2	0,045	1350	2250	2700	4050
10,0	2	0,050	1500	2500	3000	4500
11,0	2	0,055	1650	2750	3300	4950
12,0	2	0,060	1800	3000	3600	5400

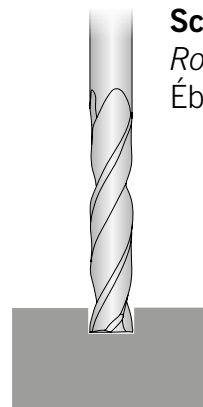

**Schruppen**  
Roughing  
Ébauche

**Achtung:** Die angegebenen Schnittparameter sind Richt- und Startwerte.

Kundenspezifische Gegebenheiten wie Antriebsleistung, Maschinenstabilität, Werkzeugauskragung etc. sind hierbei nicht berücksichtigt.

Attention: These cutting data are recommendations only.

Customer specific circumstances such as machine power, stability, tool overhang etc. are not taken into consideration.

Attention: Les paramètres de coupe indiqués sont des valeurs indicatives et initiales.

Les situations spécifiques au client, telles que la puissance motrice, la stabilité de la machine, le porte-à-faux de l'outil, etc. ne sont ici pas prises en compte.

# Empfohlene Schnittwerte Vorschubtabellen

Recommended cutting data feed tables

Tableaux des avances valeurs de coupe recommandées

## AFD50121-...

### D100-Beschichtung für Graphitbearbeitung

D100 coating for graphite machining

D100 revêtement pour l'usinage du graphite

Ø d <sub>1</sub> [mm]	Z	fz [mm]	n 15000 min1 vf [mm/min.]	n 25000 min1 vf [mm/min.]	n 30000 min1 vf [mm/min.]	n 45000 min1 vf [mm/min.]
0,5	2	0,005	150	250	300	450
0,6	2	0,006	180	300	360	540
0,7	2	0,007	210	350	420	630
0,8	2	0,009	270	450	540	810
0,9	2	0,009	270	450	540	810
1,0	2	0,011	330	550	660	990
1,5	2	0,016	480	800	960	1440
2,0	2	0,021	630	1050	1260	1890
2,5	2	0,026	780	1300	1560	2340
3,0	2	0,031	930	1550	1860	2790
3,5	2	0,036	1080	1800	2160	3240
4,0	2	0,040	1200	2000	2400	3600
5,0	2	0,045	1350	2250	2700	4050
6,0	2	0,050	1500	2500	3000	4500
7,0	2	0,055	1650	2750	3300	4950
8,0	2	0,060	1800	3000	3600	5400
9,0	2	0,065	1950	3250	3900	5850
10,0	2	0,070	2100	3500	4200	6300
11,0	2	0,075	2250	3750	4500	6750
12,0	2	0,080	2400	4000	4800	7200



Schlichten  
Finishing  
Finition

AFD

Ø d <sub>1</sub> [mm]	Z	fz [mm]	n 15000 min1 vf [mm/min.]	n 25000 min1 vf [mm/min.]	n 30000 min1 vf [mm/min.]	n 45000 min1 vf [mm/min.]
0,5	2	0,005	150	250	300	450
0,6	2	0,006	180	300	360	540
0,7	2	0,007	210	350	420	630
0,8	2	0,009	270	450	540	810
0,9	2	0,009	270	450	540	810
1,0	2	0,011	330	550	660	990
1,5	2	0,016	480	800	960	1440
2,0	2	0,021	630	1050	1260	1890
2,5	2	0,026	780	1300	1560	2340
3,0	2	0,031	930	1550	1860	2790
3,5	2	0,036	1080	1800	2160	3240
4,0	2	0,040	1200	2000	2400	3600
5,0	2	0,045	1350	2250	2700	4050
6,0	2	0,050	1500	2500	3000	4500
7,0	2	0,055	1650	2750	3300	4950
8,0	2	0,060	1800	3000	3600	5400
9,0	2	0,065	1950	3250	3900	5850
10,0	2	0,070	2100	3500	4200	6300
11,0	2	0,075	2250	3750	4500	6750
12,0	2	0,080	2400	4000	4800	7200

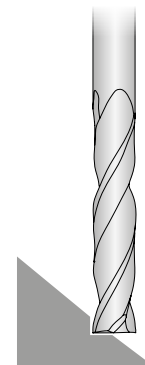

Schlichten  
Finishing  
Finition

**Achtung:** Die angegebenen Schnittparameter sind Richt- und Startwerte.

Kundenspezifische Gegebenheiten wie Antriebsleistung, Maschinenstabilität, Werkzeugauskragung etc. sind hierbei nicht berücksichtigt.

Attention: These cutting data are recommendations only.

Customer specific circumstances such as machine power, stability, tool overhang etc. are not taken into consideration.

Attention: Les paramètres de coupe indiqués sont des valeurs indicatives et initiales.

Les situations spécifiques au client, telles que la puissance motrice, la stabilité de la machine, le porte-à-faux de l'outil, etc. ne sont ici pas prises en compte.

# Empfohlene Schnittwerte Vorschubtabellen

Recommended cutting data feed tables

Tableaux des avances valeurs de coupe recommandées

## AFD51824-...

### D100-Beschichtung für Graphitbearbeitung

D100 coating for graphite machining

D100 revêtement pour l'usinage du graphite

Ø d <sub>1</sub> [mm]	Z	fz [mm]	n 15000 min1 vf [mm/min.]	n 25000 min1 vf [mm/min.]	n 30000 min1 vf [mm/min.]	n 45000 min1 vf [mm/min.]
0,2	2	0,003	90	150	180	270
0,3	2	0,004	120	200	240	360
0,4	2	0,004	120	200	240	360
0,5	2	0,005	150	250	300	450
0,6	2	0,006	180	300	360	540
0,8	2	0,008	240	400	480	720
1,0	2	0,009	270	450	540	810
1,2	2	0,011	330	550	660	990
1,5	2	0,014	420	700	840	1260
2,0	2	0,019	570	950	1140	1710
3,0	2	0,028	840	1400	1680	2520
4,0	2	0,037	1110	1850	2220	3330
5,0	2	0,046	1380	2300	2760	4140
6,0	2	0,055	1650	2750	3300	4950

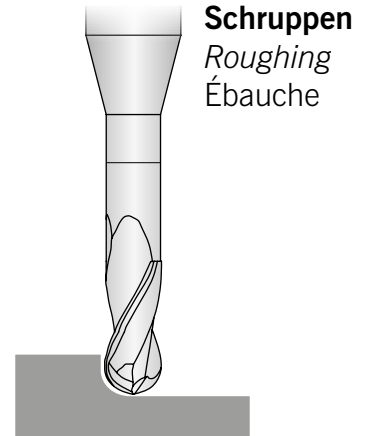

Ø d <sub>1</sub> [mm]	Z	fz [mm]	n 15000 min1 vf [mm/min.]	n 25000 min1 vf [mm/min.]	n 30000 min1 vf [mm/min.]	n 45000 min1 vf [mm/min.]
0,2	2	0,003	90	150	180	270
0,3	2	0,003	90	150	180	270
0,4	2	0,004	120	200	240	360
0,5	2	0,004	120	200	240	360
0,6	2	0,004	120	200	240	360
0,8	2	0,006	180	300	360	540
1,0	2	0,007	210	350	420	630
1,2	2	0,009	270	450	540	810
1,5	2	0,011	330	550	660	990
2,0	2	0,015	450	750	900	1350
3,0	2	0,022	660	1100	1320	1980
4,0	2	0,029	870	1450	1740	2610
5,0	2	0,036	1080	1800	2160	3240
6,0	2	0,043	1290	2150	2580	3870

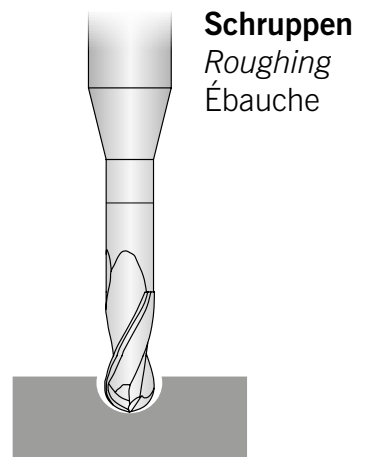

**Achtung:** Die angegebenen Schnittparameter sind Richt- und Startwerte.

Kundenspezifische Gegebenheiten wie Antriebsleistung, Maschinenstabilität, Werkzeugauskragung etc. sind hierbei nicht berücksichtigt.

Attention: These cutting data are recommendations only.

Customer specific circumstances such as machine power, stability, tool overhang etc. are not taken into consideration.

Attention: Les paramètres de coupe indiqués sont des valeurs indicatives et initiales.

Les situations spécifiques au client, telles que la puissance motrice, la stabilité de la machine, le porte-à-faux de l'outil, etc. ne sont ici pas prises en compte.

# Empfohlene Schnittwerte Vorschubtabellen

Recommended cutting data feed tables

Tableaux des avances valeurs de coupe recommandées

## AFD51824-...

### D100-Beschichtung für Graphitbearbeitung

D100 coating for graphite machining

D100 revêtement pour l'usinage du graphite

$\varnothing d_1$ [mm]	Z	fz [mm]	n 15000 min1 vf [mm/min.]	n 25000 min1 vf [mm/min.]	n 30000 min1 vf [mm/min.]	n 45000 min1 vf [mm/min.]
0,2	2	0,003	90	150	180	270
0,3	2	0,004	120	200	240	360
0,4	2	0,004	120	200	240	360
0,5	2	0,005	150	250	300	450
0,6	2	0,006	180	300	360	540
0,8	2	0,009	270	450	540	810
1,0	2	0,011	330	550	660	990
1,2	2	0,013	390	650	780	1170
1,5	2	0,016	480	800	960	1440
2,0	2	0,021	630	1050	1260	1890
3,0	2	0,032	960	1600	1920	2880
4,0	2	0,042	1260	2100	2520	3780
5,0	2	0,053	1590	2650	3180	4770
6,0	2	0,063	1890	3150	3780	5670

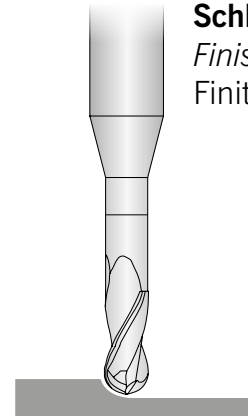

Schlichten  
Finishing  
Finition

AFD

$\varnothing d_1$ [mm]	Z	fz [mm]	n 15000 min1 vf [mm/min.]	n 25000 min1 vf [mm/min.]	n 30000 min1 vf [mm/min.]	n 45000 min1 vf [mm/min.]
0,2	2	0,003	90	150	180	270
0,3	2	0,004	120	200	240	360
0,4	2	0,004	120	200	240	360
0,5	2	0,005	150	250	300	450
0,6	2	0,006	180	300	360	540
0,8	2	0,009	270	450	540	810
1,0	2	0,011	330	550	660	990
1,2	2	0,013	390	650	780	1170
1,5	2	0,016	480	800	960	1440
2,0	2	0,021	630	1050	1260	1890
3,0	2	0,032	960	1600	1920	2880
4,0	2	0,042	1260	2100	2520	3780
5,0	2	0,053	1590	2650	3180	4770
6,0	2	0,063	1890	3150	3780	5670

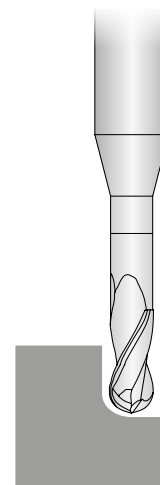

Schlichten  
Finishing  
Finition

**Achtung:** Die angegebenen Schnittparameter sind Richt- und Startwerte.

Kundenspezifische Gegebenheiten wie Antriebsleistung, Maschinenstabilität, Werkzeugauskragung etc. sind hierbei nicht berücksichtigt.

Attention: These cutting data are recommendations only.

Customer specific circumstances such as machine power, stability, tool overhang etc. are not taken into consideration.

Attention: Les paramètres de coupe indiqués sont des valeurs indicatives et initiales.

Les situations spécifiques au client, telles que la puissance motrice, la stabilité de la machine, le porte-à-faux de l'outil, etc. ne sont ici pas prises en compte.

# Empfohlene Schnittwerte Vorschubtabellen

Recommended cutting data feed tables

Tableaux des avances valeurs de coupe recommandées

## AFD54030-...

### D100-Beschichtung für Graphitbearbeitung

D100 coating for graphite machining

D100 revêtement pour l'usinage du graphite

$\varnothing d_1$ [mm]	Z	fz [mm]	n 10000 min1 vf [mm/min.]	n 15000 min1 vf [mm/min.]	n 20000 min1 vf [mm/min.]	n 30000 min1 vf [mm/min.]
2,0	3	0,024	720	1080	1440	2160
3,0	3	0,035	1050	1575	2100	3150
4,0	3	0,047	1410	2115	2820	4230
5,0	3	0,059	1770	2655	3540	5310
6,0	3	0,071	2130	3195	4260	6390
8,0	3	0,094	2820	4230	5640	8460
10,0	3	0,118	3540	5310	7080	10620
12,0	3	0,141	4230	6345	8460	12690

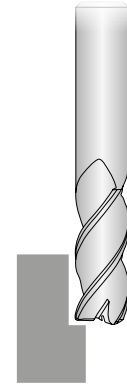

**Schruppen**  
Roughing  
Ébauche

$\varnothing d_1$ [mm]	Z	fz [mm]	n 10000 min1 vf [mm/min.]	n 15000 min1 vf [mm/min.]	n 20000 min1 vf [mm/min.]	n 30000 min1 vf [mm/min.]
2,0	3	0,018	540	810	1080	1620
3,0	3	0,027	810	1215	1620	2430
4,0	3	0,036	1080	1620	2160	3240
5,0	3	0,045	1350	2025	2700	4050
6,0	3	0,055	1650	2475	3300	4950
8,0	3	0,073	2190	3285	4380	6570
10,0	3	0,091	2730	4095	5460	8190
12,0	3	0,109	3270	4905	6540	9810

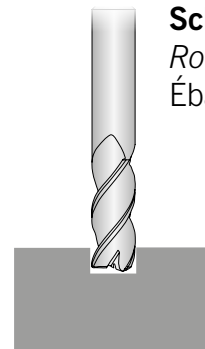

**Schruppen**  
Roughing  
Ébauche

**Achtung:** Die angegebenen Schnittparameter sind Richt- und Startwerte.  
Kundenspezifische Gegebenheiten wie Antriebsleistung, Maschinenstabilität, Werkzeugauskragung etc. sind hierbei nicht berücksichtigt.

Attention: These cutting data are recommendations only.  
Customer specific circumstances such as machine power, stability, tool overhang etc. are not taken into consideration.

Attention: Les paramètres de coupe indiqués sont des valeurs indicatives et initiales.  
Les situations spécifiques au client, telles que la puissance motrice, la stabilité de la machine, le porte-à-faux de l'outil, etc. ne sont ici pas prises en compte.



# Empfohlene Schnittwerte Vorschubtabellen

Recommended cutting data feed tables

Tableaux des avances valeurs de coupe recommandées

## AFD54030-...

### D100-Beschichtung für Graphitbearbeitung

D100 coating for graphite machining

D100 revêtement pour l'usinage du graphite

Ø d <sub>1</sub> [mm]	Z	fz [mm]	n 10000 min1 vf [mm/min.]	n 15000 min1 vf [mm/min.]	n 20000 min1 vf [mm/min.]	n 30000 min1 vf [mm/min.]
2,0	3	0,027	810	1215	1620	2430
3,0	3	0,040	1200	1800	2400	3600
4,0	3	0,053	1590	2385	3180	4770
5,0	3	0,067	2010	3015	4020	6030
6,0	3	0,080	2400	3600	4800	7200
8,0	3	0,107	3210	4815	6420	9630
10,0	3	0,133	3990	5985	7980	11970
12,0	3	0,160	4800	7200	9600	14400

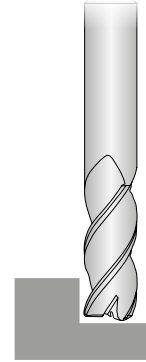

Schlichten  
Finishing  
Finition

AFD

Ø d <sub>1</sub> [mm]	Z	fz [mm]	n 10000 min1 vf [mm/min.]	n 15000 min1 vf [mm/min.]	n 20000 min1 vf [mm/min.]	n 30000 min1 vf [mm/min.]
2,0	3	0,027	810	1215	1620	2430
3,0	3	0,040	1200	1800	2400	3600
4,0	3	0,053	1590	2385	3180	4770
5,0	3	0,067	2010	3015	4020	6030
6,0	3	0,080	2400	3600	4800	7200
8,0	3	0,107	3210	4815	6420	9630
10,0	3	0,133	3990	5985	7980	11970
12,0	3	0,160	4800	7200	9600	14400

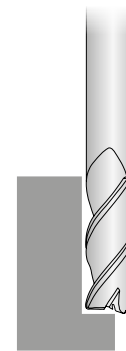

Schlichten  
Finishing  
Finition

**Achtung:** Die angegebenen Schnittparameter sind Richt- und Startwerte.

Kundenspezifische Gegebenheiten wie Antriebsleistung, Maschinenstabilität, Werkzeugauskrantung etc. sind hierbei nicht berücksichtigt.

Attention: These cutting data are recommendations only.

Customer specific circumstances such as machine power, stability, tool overhang etc. are not taken into consideration.

Attention: Les paramètres de coupe indiqués sont des valeurs indicatives et initiales.

Les situations spécifiques au client, telles que la puissance motrice, la stabilité de la machine, le porte-à-faux de l'outil, etc. ne sont ici pas prises en compte.

# Empfohlene Schnittwerte Vorschubtabellen

Recommended cutting data feed tables

Tableaux des avances valeurs de coupe recommandées

## AFD54031-...

### D100-Beschichtung für Graphitbearbeitung

D100 coating for graphite machining

D100 revêtement pour l'usinage du graphite

$\varnothing d_1$ [mm]	Z	fz [mm]	n 10000 min1 vf [mm/min.]	n 15000 min1 vf [mm/min.]	n 20000 min1 vf [mm/min.]	n 30000 min1 vf [mm/min.]
2,0	3	0,021	630	945	1260	1890
3,0	3	0,032	960	1440	1920	2880
4,0	3	0,043	1290	1935	2580	3870
5,0	3	0,053	1590	2385	3180	4770
6,0	3	0,064	1920	2880	3840	5760
8,0	3	0,085	2550	3825	5100	7650
10,0	3	0,107	3210	4815	6420	9630
12,0	3	0,128	3840	5760	7680	11520

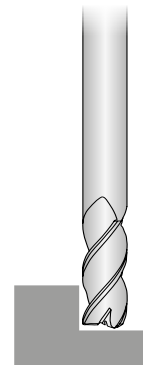

**Schlichten**  
Finishing  
Finition

**Achtung:** Die angegebenen Schnittparameter sind Richt- und Startwerte.

Kundenspezifische Gegebenheiten wie Antriebsleistung, Maschinenstabilität, Werkzeugauskrantung etc. sind hierbei nicht berücksichtigt.

Attention: These cutting data are recommendations only.

Customer specific circumstances such as machine power, stability, tool overhang etc. are not taken into consideration.

Attention: Les paramètres de coupe indiqués sont des valeurs indicatives et initiales.

Les situations spécifiques au client, telles que la puissance motrice, la stabilité de la machine, le porte-à-faux de l'outil, etc. ne sont ici pas prises en compte.

# ARNO®

## WERKZEUGE

We have a passion for precision.

# AUSFÜHRUNG AFE

Design AFE / Modèle AFE

**Ideal für die Hochgeschwindigkeitsbearbeitung von exotischen Materialien (Titan, Inconel) und rostfreien Stählen.**

*Ideal for high speed machining of exotic materials (Titanium, Inconel) and stainless steels.*

*Idéal pour un usinage à grande vitesse des matériaux exotiques (titane, Inconel) et des aciers inoxydables.*

**Universelle Schaftfräser für die Schrupp- und Schlichtbearbeitung von schwer zerspanbaren Werkstoffen.**

**Besonders geeignet für die Luft- und Raumfahrtindustrie, sowie die Energie- und Stromerzeugung. Die spezielle Beschichtung erreicht eine höhere Verschleißfestigkeit, eine bessere Oxidationsbeständigkeit und weist eine hohe thermische Stabilität auf.**



*Tools for Aerospace Industry, Energy & Power generation. For Roughing and Semi-finishing for universal use, also for Finishing difficult-to-machine materials. The special coating achieves higher wear resistance, better oxidation resistance and higher thermal stability.*

Fraise à queue universelles pour le dégrossissage et le fraisage de matériaux difficilement décolletable. Convient particulièrement bien à une application dans l'industrie aéronautique et à la production électrique. Le revêtement spécial offre une meilleure résistance à l'usure, à l'oxydation et offre une grande stabilité thermique.

## AFE51840-...(R)...

4 Schneiden, kurze Ausführung, mit Eckenradius / 4 flutes, short design, with corner radius / 4 dents, version courte avec rayon d'angle

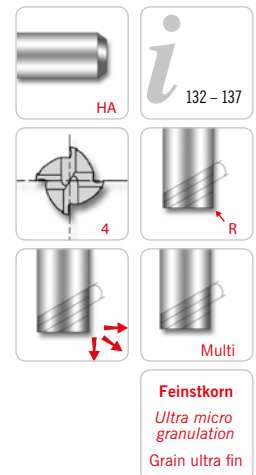
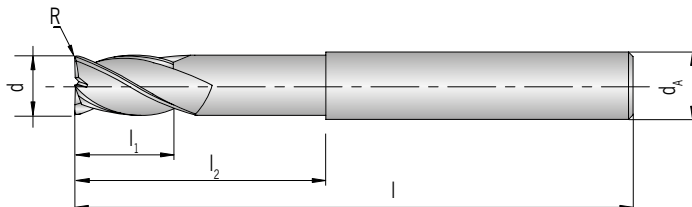

**N** NEU/NEW/NOUVEAU

PG 24

beschichtet  
coated  
revêtu

Schaft DIN 6535HA Shank Tige	d -0,03	d <sub>A</sub> h6	l <sub>1</sub>	l <sub>2</sub>	l	R	E200
AFE51840-060R0,5	6	6	20	13	57	0,5	●
AFE51840-060R1,0	6	6	20	13	57	1,0	●
AFE51840-080R0,5	8	8	25	19	63	0,5	●
AFE51840-080R1,0	8	8	25	19	63	1,0	●
AFE51840-080R1,5	8	8	25	19	63	1,5	●
AFE51840-080R2,0	8	8	25	19	63	2,0	●
AFE51840-100R0,5	10	10	30	22	72	0,5	●
AFE51840-100R1,0	10	10	30	22	72	1,0	●
AFE51840-100R1,5	10	10	30	22	72	1,5	●
AFE51840-100R2,0	10	10	30	22	72	2,0	●
AFE51840-120R0,5	12	12	35	26	83	0,5	●
AFE51840-120R1,0	12	12	35	26	83	1,0	●
AFE51840-120R1,5	12	12	35	26	83	1,5	●
AFE51840-120R2,0	12	12	35	26	83	2,0	●
AFE51840-120R3,0	12	12	35	26	83	3,0	●
AFE51840-140R1,0	14	14	35	26	83	1,0	●
AFE51840-140R2,0	14	14	35	26	83	2,0	●
AFE51840-160R1,0	16	16	43	35	92	1,0	●
AFE51840-160R1,5	16	16	43	35	92	1,5	●
AFE51840-160R2,0	16	16	43	35	92	2,0	●
AFE51840-160R3,0	16	16	43	35	92	3,0	●
AFE51840-160R4,0	16	16	43	35	92	4,0	●
AFE51840-200R1,0	20	20	56	44	110	1,0	●
AFE51840-200R1,5	20	20	56	44	110	1,5	●
AFE51840-200R2,0	20	20	56	44	110	2,0	●
AFE51840-200R3,0	20	20	56	44	110	3,0	●
AFE51840-200R3,5	20	20	56	44	110	3,5	●
AFE51840-200R4,0	20	20	56	44	110	4,0	●
AFE51840-250R1,0	25	25	70	55	130	1,0	●
AFE51840-250R1,5	25	25	70	55	130	1,5	●

Solid carbide end-mill

Fraise carbure monobloc à tige

							PG 24
							beschichtet coated revêtu
Schaft DIN 6535HA Shank Tige	d -0,03	d <sub>A</sub> h6	l <sub>1</sub>	l <sub>2</sub>	l	R	E200
AFE51840-250R2,0	25	25	70	55	130	2,0	●
AFE51840-250R3,0	25	25	70	55	130	3,0	●
AFE51840-250R4,0	25	25	70	55	130	4,0	●

P	
M	
K	
N	
S	●
H	

- **Hauptanwendung**  
Main application  
Application principale
- **Nebenanwendung**  
Secondary application  
Application secondaire

AFE

Solid carbide end-mill  
Fraise carbure monobloc à tige

## AFE51850-...

5 Schneiden, kurze Ausführung / 5 flutes, short design / 5 dents, version courte

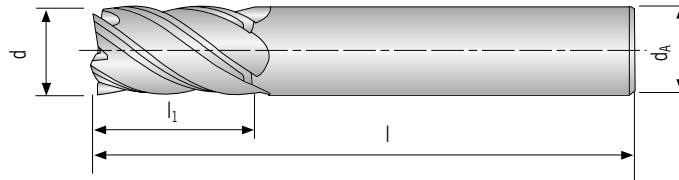

AFE

**N** NEU/NEW/  
NOUVEAU

PG 24

beschichtet  
coated  
revêtu

Schaft DIN 6535HA  
Shank  
Tige

	d -0,03	d <sub>A</sub> h6	l <sub>1</sub>	l	Fase / Chamfer	E200
AFE51850-060 <b>N</b>	6	6	10	54	0,2x45°	●
AFE51850-080 <b>N</b>	8	8	12	58	0,2x45°	●
AFE51850-100 <b>N</b>	10	10	14	66	0,3x45°	●
AFE51850-120 <b>N</b>	12	12	16	73	0,35x45°	●
AFE51850-160 <b>N</b>	16	16	22	82	0,4x45°	●
AFE51850-200 <b>N</b>	20	20	26	92	0,5x45°	●
AFE51850-250 <b>N</b>	25	25	29	100	0,5x45°	●

P	
M	
K	
N	
S	●
H	

● **Hauptanwendung**  
Main application  
Application principale

○ **Nebenanwendung**  
Secondary application  
Application secondaire

Solid carbide end-mill

Fraise carbure monobloc à tige

## AFE51850-...(R)...

5 Schneiden, kurze Ausführung mit Eckenradius / 5 flutes, short design with corner radius / 5 dents, version courte avec rayon d'angle

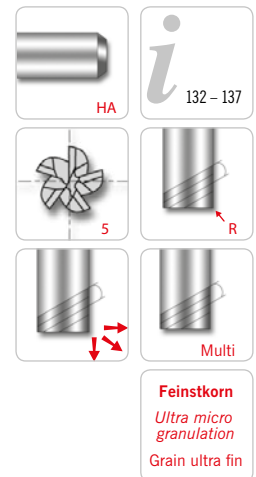
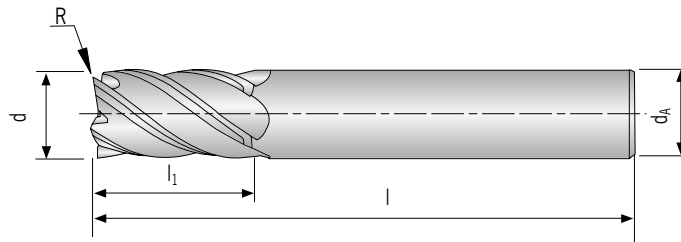

AFE

**N** NEU/NEW/NOUVEAU

							PG 24
							beschichtet coated revêtu
Schaft DIN 6535HA Shank Tige	d -0,03	d <sub>A</sub> h6	l <sub>1</sub>	l	R	E200	
AFE51850-060R0,5 <b>N</b>	6	6	10	54	0,5	●	
AFE51850-080R0,5 <b>N</b>	8	8	12	58	0,5	●	
AFE51850-100R0,5 <b>N</b>	10	10	14	66	0,5	●	
AFE51850-120R0,5 <b>N</b>	12	12	16	73	0,5	●	
AFE51850-160R1,0 <b>N</b>	16	16	22	82	1,0	●	
AFE51850-200R1,0 <b>N</b>	20	20	26	92	1,0	●	
AFE51850-250R1,0 <b>N</b>	25	25	29	100	1,0	●	

P	
M	
K	
N	
S	●
H	

● Hauptanwendung  
Main application  
Application principale

○ Nebenanwendung  
Secondary application  
Application secondaire

## AFE51851-...

5 Schneiden, lange Ausführung / 5 flutes, long design / 5 dents, version longue

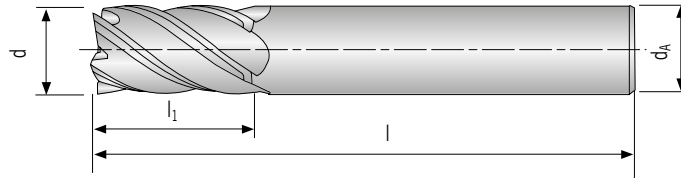

**N** NEU/NEW/NOUVEAU

PG 24

beschichtet  
coated  
revêtu

Schaft DIN 6535HA

Shank  
Tige

	d -0,03	d <sub>A</sub> h6	l <sub>1</sub>	l	Fase / Chamfer	E200
AFE51851-060 <b>N</b>	6	6	13	57	0,2x45°	●
AFE51851-080 <b>N</b>	8	8	19	63	0,2x45°	●
AFE51851-100 <b>N</b>	10	10	22	72	0,3x45°	●
AFE51851-120 <b>N</b>	12	12	26	83	0,35x45°	●
AFE51851-160 <b>N</b>	16	16	36	92	0,4x45°	●
AFE51851-200 <b>N</b>	20	20	44	104	0,5x45°	●
AFE51851-250 <b>N</b>	25	25	54	121	0,5x45°	●

P	
M	
K	
N	
S	●
H	

● Hauptanwendung  
Main application  
Application principale

○ Nebenanwendung  
Secondary application  
Application secondaire



## AFE51851-...(R)...

5 Schneiden, lange Ausführung mit Eckenradius / 5 flutes, long design with corner radius / 5 dents, version longue, avec rayon d'angle

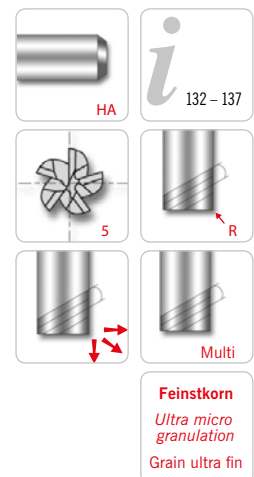
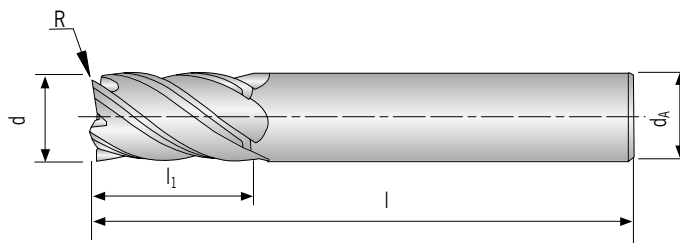

AFE

**N** NEU/NEW/NOUVEAU

PG 24

beschichtet  
coated  
revêtu

Schaft DIN 6535HA Shank Tige	d -0,03	d <sub>A</sub> h6	l <sub>1</sub>	l	R	E200
AFE51851-060R0,3 <b>N</b>	6	6	13	57	0,3	●
AFE51851-060R0,5 <b>N</b>	6	6	13	57	0,5	●
AFE51851-060R1,0 <b>N</b>	6	6	13	57	1,0	●
AFE51851-080R0,5 <b>N</b>	8	8	19	63	0,5	●
AFE51851-080R1,0 <b>N</b>	8	8	19	63	1,0	●
AFE51851-080R1,5 <b>N</b>	8	8	19	63	1,5	●
AFE51851-080R2,0 <b>N</b>	8	8	19	63	2,0	●
AFE51851-100R0,5 <b>N</b>	10	10	22	72	0,5	●
AFE51851-100R1,0 <b>N</b>	10	10	22	72	1,0	●
AFE51851-100R1,5 <b>N</b>	10	10	22	72	1,5	●
AFE51851-100R2,0 <b>N</b>	10	10	22	72	2,0	●
AFE51851-120R0,5 <b>N</b>	12	12	26	83	0,5	●
AFE51851-120R1,0 <b>N</b>	12	12	26	83	1,0	●
AFE51851-120R1,5 <b>N</b>	12	12	26	83	1,5	●
AFE51851-120R2,0 <b>N</b>	12	12	26	83	2,0	●
AFE51851-120R2,5 <b>N</b>	12	12	26	83	2,5	●
AFE51851-120R3,0 <b>N</b>	12	12	26	83	3,0	●
AFE51851-160R1,0 <b>N</b>	16	16	36	92	1,0	●
AFE51851-160R1,5 <b>N</b>	16	16	36	92	1,5	●
AFE51851-160R2,0 <b>N</b>	16	16	36	92	2,0	●
AFE51851-160R2,5 <b>N</b>	16	16	36	92	2,5	●
AFE51851-160R3,0 <b>N</b>	16	16	36	92	3,0	●
AFE51851-160R4,0 <b>N</b>	16	16	36	92	4,0	●
AFE51851-200R1,0 <b>N</b>	20	20	44	104	1,0	●
AFE51851-200R1,5 <b>N</b>	20	20	44	104	1,5	●
AFE51851-200R2,0 <b>N</b>	20	20	44	104	2,0	●
AFE51851-200R2,5 <b>N</b>	20	20	44	104	2,5	●
AFE51851-200R3,0 <b>N</b>	20	20	44	104	3,0	●
AFE51851-200R4,0 <b>N</b>	20	20	44	104	4,0	●
AFE51851-200R5,0 <b>N</b>	20	20	44	104	5,0	●
AFE51851-250R1,0 <b>N</b>	25	25	54	121	1,0	●

PG 24

beschichtet  
coated  
revêtu

Schaft DIN 6535HA Shank Tige	d -0,03	d <sub>A</sub> h6	l <sub>1</sub>	l	R	E200
AFE51851-250R1,5 <b>N</b>	25	25	54	121	1,5	●
AFE51851-250R2,0 <b>N</b>	25	25	54	121	2,0	●
AFE51851-250R2,5 <b>N</b>	25	25	54	121	2,5	●
AFE51851-250R3,0 <b>N</b>	25	25	54	121	3,0	●
AFE51851-250R4,0 <b>N</b>	25	25	54	121	4,0	●
AFE51851-250R5,0 <b>N</b>	25	25	54	121	5,0	●

P	
M	
K	
N	
S	●
H	

- **Hauptanwendung**  
Main application  
Application principale
- **Nebenanwendung**  
Secondary application  
Application secondaire

Solid carbide roughing end-mill  
Fraise carbure monobloc d'ébauche

## AFE52451-...(R)...

5 Schneiden, lange Ausführung mit Eckenradius / 5 flutes, long design with corner radius / 5 dents, version longue, avec rayon d'angle

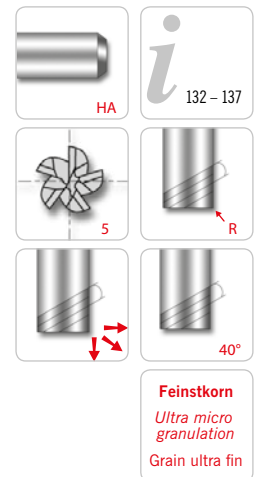
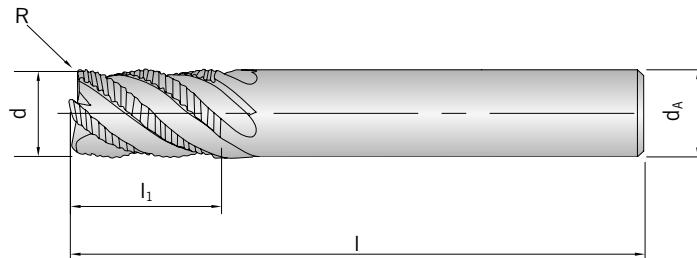

**N** NEU/NEW/  
NOUVEAU

							PG 24
							beschichtet coated revêtu
Schaft Shank Tige	d	d <sub>A</sub>	l <sub>1</sub>	l	R	TiAIN	
AFE52451-060R0,2 <b>N</b>	6	6	16	57	0,2	●	
AFE52451-080R0,2 <b>N</b>	8	8	16	63	0,2	●	
AFE52451-100R0,3 <b>N</b>	10	10	22	72	0,3	●	
AFE52451-120R0,3 <b>N</b>	12	12	26	83	0,3	●	
AFE52451-140R0,3 <b>N</b>	14	14	26	83	0,3	●	
AFE52451-160R0,3 <b>N</b>	16	16	32	92	0,3	●	
AFE52451-200R0,3 <b>N</b>	20	20	38	104	0,3	●	
AFE52451-250R0,3 <b>N</b>	25	25	45	121	0,3	●	

P	
M	
K	
N	
S	●
H	

● Hauptanwendung  
Main application  
Application principale  
○ Nebenanwendung  
Secondary application  
Application secondaire

AFE

Unlegierter Stahl / Carbon steel / Acier non allié < 300 Brinell 1.1191 (C45) • 1.0726 (35 S 20) • 1.0715 (9 SMn 28) • 1.0718 (9 SMnPb 28)							Unlegierter Stahl / Carbon steel / Acier non allié > 300 / < 380 Brinell 1.2330 (35 CrMo 4) • 1.6565 (40NiCrMo6) • 1.7033 (34Cr4) • 1.6523 (21 NiCrMo2)					
Umfangsfräsen Side cutting Contournage			Nutfräse Slotting Rainurage				Umfangsfräsen Side cutting Contournage			Nutfräse Slotting Rainurage		
Ap 1 x d / Ae 0,4 x d			Ap 1 x d / Ae 1 x d				Ap 1 x d / Ae 0,4 x d			Ap 1 x d / Ae 1 x d		
Vc = 128 - 160 - 192 m/min			Vc = 100 - 125 - 150 m/min				Vc = 120 - 150 - 180 m/min			Vc = 96 - 120 - 144 m/min		
d (mm)	RPM (U/min)	Fz (mm/Zahn)	FEED (mm/min)	RPM (U/min)	Fz (mm/Zahn)	FEED (mm/min)	RPM (U/min)	Fz (mm/Zahn)	FEED (mm/min)	RPM (U/min)	Fz (mm/Zahn)	FEED (mm/min)
6	8488	0,027	917	6631	0,025	663	7958	0,025	796	6366	0,025	637
8	6366	0,035	891	4974	0,034	676	5968	0,035	836	4775	0,034	649
10	5093	0,042	856	3979	0,042	668	4775	0,042	802	3820	0,042	642
12	4244	0,053	900	3316	0,049	650	3979	0,049	780	3183	0,049	624
14	3638	0,058	844	2842	0,056	637	3410	0,056	764	2728	0,056	611
16	3183	0,063	802	2487	0,063	627	2984	0,063	752	2387	0,063	602
20	2546	0,077	784	1989	0,07	557	2387	0,070	668	1910	0,07	535
25	2037	0,084	684	1592	0,084	535	1910	0,084	642	1528	0,077	471

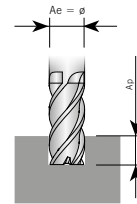
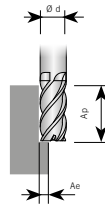
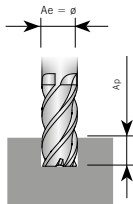
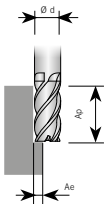

Werkzeugstahl / Tool steels / Acier à outils > 380 Brinell 1.2363 (X100 CrMoV 5 1) • 1.2379 (X155 CrMo 12 1) • 1.2344 (X40 CrMoV 5 1) • 1.3243 (S 6-5-2-5)							Gusseisen / Cast iron < 280 Brinell 0.6020 (GG20) • 0.8145 (GTS-45-06) • 0.7060 (GGG-60)					
Umfangsfräsen Side cutting Contournage			Nutfräse Slotting Rainurage				Umfangsfräsen Side cutting Contournage			Nutfräse Slotting Rainurage		
Ap 1 x d / Ae 0,4 x d			Ap 1 x d / Ae 1 x d				Ap 1 x d / Ae 0,4 x d			Ap 1 x d / Ae 1 x d		
Vc = 120 - 150 - 180 m/min			Vc = 96 - 120 - 144 m/min				Vc = 140 - 175 - 210 m/min			Vc = 112 - 140 - 168 m/min		
d (mm)	RPM (U/min)	Fz (mm/Zahn)	FEED (mm/min)	RPM (U/min)	Fz (mm/Zahn)	FEED (mm/min)	RPM (U/min)	Fz (mm/Zahn)	FEED (mm/min)	RPM (U/min)	Fz (mm/Zahn)	FEED (mm/min)
6	7958	0,027	859	6366	0,027	688	9284	0,021	780	7427	0,021	624
8	5968	0,035	836	4775	0,035	668	6963	0,028	780	5570	0,028	624
10	4775	0,046	879	3820	0,042	642	5570	0,035	780	4456	0,035	624
12	3979	0,053	844	3183	0,053	675	4642	0,042	780	3714	0,042	624
14	3410	0,06	819	2728	0,058	633	3979	0,048	764	3183	0,048	611
16	2984	0,067	800	2387	0,063	602	3482	0,053	738	2785	0,053	590
20	2387	0,077	735	1910	0,077	588	2785	0,06	668	2228	0,06	535
25	1910	0,084	642	1528	0,084	513	2228	0,07	624	1783	0,067	478

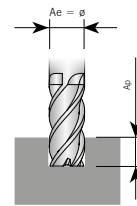
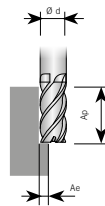
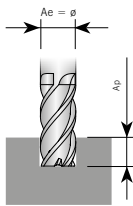
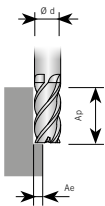

Die Tabellenwerte sind Richtwerte. Es kann notwendig sein, die Werte den jeweiligen Bearbeitungsumständen anzupassen. Bei Schlichtschnitten verwenden Sie reduzierte Vorschubgeschwindigkeiten und/oder höhere Drehzahlen (2% x d1). Bei härteren Materialien reduzieren Sie Geschwindigkeit und Vorschub.

The recommended cutting data are only approximate values. It may be necessary to adjust them to each individual machining application. Finish cuts typically require reduced feed rates and/or higher spindle speed, with radial width of 2% x d1 or less. Reduce speed and feed recommendations for materials harder than listed.

Les valeurs du tableau sont indicatives. Il peut être nécessaire de les adapter aux conditions d'usinage respectives. Pour les découpes de dégrossissage, vous utilisez des vitesses d'avance réduites et/ou des vitesses de rotation plus élevées (2% x d1). Avec des matériaux plus durs, vous réduisez la vitesse et la course avant.

Rostfreier Stahl / Stainless steel 300 / Acier inoxydable 300							Rostfreier Stahl / Stainless steel 400 / Acier inoxydable 400					
1.4301(X5 CrNi 18 10) • 1.4436(X3 CrNiMo 17 13 3) • 1.4306(X2 CrNi 19 11) • 1.4435(X2 CrNiMo 18 14 3)							1.4005(X12 CrS 13) • 1.4104(X14 CrMoS 17)					
Umfangsfräsen Side cutting Contournage			Nutfräse Slotting Rainurage				Umfangsfräsen Side cutting Contournage			Nutfräse Slotting Rainurage		
Ap 1 x d / Ae 0,4 x d			Ap 1 x d / Ae 1 x d				Ap 1 x d / Ae 0,4 x d			Ap 1 x d / Ae 1 x d		
Vc = 84 - 105 - 126 m/min			Vc = 68 - 85 - 102 m/min				Vc = 124 - 155 - 186 m/min			Vc = 100 - 125 - 150 m/min		
d (mm)	RPM (U/min)	Fz (mm/Zahn)	FEED (mm/min)	RPM (U/min)	Fz (mm/Zahn)	FEED (mm/min)	RPM (U/min)	Fz (mm/Zahn)	FEED (mm/min)	RPM (U/min)	Fz (mm/Zahn)	FEED (mm/min)
6	5570	0,025	550	4509	0,025	446	8223	0,034	1125	6631	0,034	907
8	4178	0,034	572	3382	0,034	463	6167	0,046	1125	4974	0,046	907
10	3342	0,042	559	2706	0,042	452	4934	0,057	1125	3979	0,057	907
12	2785	0,048	529	2255	0,048	428	4112	0,067	1094	3316	0,067	882
14	2387	0,055	525	1933	0,056	425	3524	0,076	1071	2842	0,074	841
16	2089	0,062	516	1691	0,062	418	3084	0,086	1055	2487	0,081	803
20	1671	0,071	476	1353	0,071	386	2467	0,095	937	1989	0,095	756
25	1337	0,081	432	1082	0,081	350	1974	0,114	900	1592	0,105	665

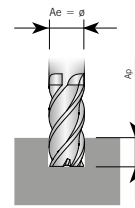
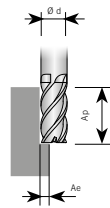
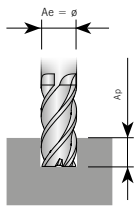
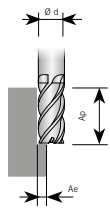

Rostfreierr Stahl / Stainless steel PH / PH Acier inoxydable							Titan / Titanium / Titane					
1.4594(27 CNU 1505)							Ti6Al4V • Ti5Al5V5Mo • Ti7Al4Mo					
Umfangsfräsen Side cutting Contournage			Nutfräse Slotting Rainurage				Umfangsfräsen Side cutting Contournage			Nutfräse Slotting Rainurage		
Ap 1 x d / Ae 0,4 x d			Ap 1 x d / Ae 1 x d				Ap 1 x d / Ae 0,4 x d			Ap 1 x d / Ae 1 x d		
Vc = 35 - 44 - 53 m/min			Vc = 29 - 36 - 43 m/min				Vc = 56 - 70 - 84 m/min			Vc = 44 - 55 - 66 m/min		
d (mm)	RPM (U/min)	Fz (mm/Zahn)	FEED (mm/min)	RPM (U/min)	Fz (mm/Zahn)	FEED (mm/min)	RPM (U/min)	Fz (mm/Zahn)	FEED (mm/min)	RPM (U/min)	Fz (mm/Zahn)	FEED (mm/min)
6	2334	0,016	151	1910	0,016	123	3714	0,034	508	2918	0,034	399
8	1751	0,021	146	1432	0,021	120	2785	0,048	529	2188	0,046	399
10	1401	0,027	149	1146	0,027	122	2228	0,057	508	1751	0,057	399
12	1167	0,032	151	955	0,032	123	1857	0,067	494	1459	0,067	388
14	1000	0,036	144	819	0,036	118	1592	0,076	484	1251	0,076	380
16	875	0,04	140	716	0,04	114	1393	0,086	476	1094	0,086	374
20	700	0,046	128	573	0,046	105	1114	0,095	423	875	0,095	333
25	560	0,052	117	458	0,052	96	891	0,114	406	700	0,105	293

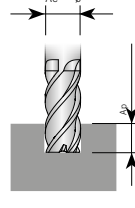
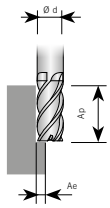
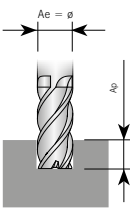
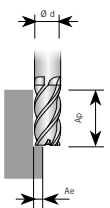

Die Tabellenwerte sind Richtwerte. Es kann notwendig sein, die Werte den jeweiligen Bearbeitungsumständen anzupassen. Bei Schlichtschnitten verwenden Sie reduzierte Vorschubgeschwindigkeiten und/oder höhere Drehzahlen (2% x d1). Bei härteren Materialien reduzieren Sie Geschwindigkeit und Vorschub.

The recommended cutting data are only approximate values. It may be necessary to adjust them to each individual machining application. Finish cuts typically require reduced feed rates and/or higher spindle speed, with radial width of 2% x d1 or less. Reduce speed and feed recommendations for materials harder than listed.

Les valeurs du tableau sont indicatives. Il peut être nécessaire de les adapter aux conditions d'usinage respectives. Pour les découpes de dégrossissage, vous utilisez des vitesses d'avance réduites et/ou des vitesses de rotation plus élevées (2% x d1). Avec des matériaux plus durs, vous réduisez la vitesse et la course avant.

Recommended cutting data feed tables

Tableaux des avances valeurs de coupe recommandées

### Hochtemperaturlegierungen / High Temperature Alloys / Alliages à haute température

RENE • INCONEL • WASPALOY • HASTELLOY

**Umfangsfraßen**  
Side cutting  
Contournage

$A_p 0,6 \times d / A_e 0,3 \times d$

$V_c = 26 - 32 - 38 \text{ m/min}$

**Nutfräse**  
Slotting  
Rainurage

$A_p 0,4 \times d / A_e 1 \times d$

$V_c = 20 - 55 - 30 \text{ m/min}$

d (mm)	RPM (U/min)	Fz (mm/Zahn)	FEED (mm/min)	RPM (U/min)	Fz (mm/Zahn)	FEED (mm/min)
6	1698	0,02	136	1326	0,018	95
8	1273	0,026	132	995	0,024	95
10	1019	0,032	130	796	0,03	95
12	849	0,038	129	663	0,036	95
14	728	0,044	128	568	0,04	91
16	637	0,048	122	497	0,044	88
20	509	0,055	112	398	0,05	80
25	407	0,065	106	318	0,055	70

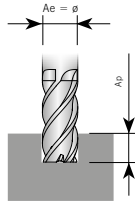
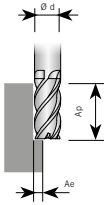

Die Tabellenwerte sind Richtwerte. Es kann notwendig sein, die Werte den jeweiligen Bearbeitungsumständen anzupassen. Bei Schlichtschnitten verwenden Sie reduzierte Vorschubgeschwindigkeiten und/oder höhere Drehzahlen (2% x d1). Bei härteren Materialien reduzieren Sie Geschwindigkeit und Vorschub.

The recommended cutting data are only approximate values. It may be necessary to adjust them to each individual machining application. Finish cuts typically require reduced feed rates and/or higher spindle speed, with radial width of 2% x d1 or less. Reduce speed and feed recommendations for materials harder than listed.

Les valeurs du tableau sont indicatives. Il peut être nécessaire de les adapter aux conditions d'usinage respectives. Pour les découpes de dégrossissage, vous utilisez des vitesses d'avance réduites et/ou des vitesses de rotation plus élevées (2% x d1). Avec des matériaux plus durs, vous réduisez la vitesse et la course avant.

Unlegierter Stahl / Carbon steel / Acier non allié				Unlegierter Stahl / Carbon steel / Acier non allié				Werkzeugstahl / Tool steels / Acier à outils				Gusseisen / Cast iron / Fonte			
< 300 Brinell				> 300 / < 380 Brinell				> 380 Brinell				< 260 Brinell			
1.1191 (C45) • 1.0726 (35 S 20) • 1.0715 (9 SMn 28) • 1.0718 (9 SMn Pb 28)				1.2330 (35 CrMo 4) • 1.6565 (40NiCrMo6) • 1.7033 (34Cr4) • 1.6523 (21 NiCrMo2)				1.2363 (X100 CrMoV 5 1) • 1.2379 (X155 CrVMo 12 1) • 1.2344 (X40 CrMoV 5 1) • 1.3243 (S 6-5-2-5)				0.6020 (GG20) 0.8145 (GTS-45-06) 0.7060 (GGG-60)			
Umfangsfraßen / Side cutting / Contournage				Umfangsfraßen / Side cutting / Contournage				Umfangsfraßen / Side cutting / Contournage				Umfangsfraßen / Side cutting / Contournage			
Ap 1,5 x d / Ae 0,3 x d				Ap 1,5 x d / Ae 0,3 x d				Ap 1,5 x d / Ae 0,3 x d				Ap 1,5 x d / Ae 0,3 x d			
Vc = 115 - 144 - 173 m/min				Vc = 81 - 101 - 121 m/min				Vc = 48 - 60 - 72 m/min				Vc = 85 - 106 - 127 m/min			
d	RPM	Fz	FEED	d	RPM	Fz	FEED	d	RPM	Fz	FEED	d	RPM	Fz	FEED
(mm)	(U/min)	(mm/Zahn)	(mm/min)	(mm)	(U/min)	(mm/Zahn)	(mm/min)	(mm)	(U/min)	(mm/Zahn)	(mm/min)	(mm)	(U/min)	(mm/Zahn)	(mm/min)
6	7639	0,034	1299	5358	0,034	911	3183	0,024	382	5623	0,043	1209			
8	5730	0,038	1089	4019	0,038	764	2387	0,027	322	4218	0,048	1012			
10	4584	0,050	1146	3215	0,050	804	1910	0,035	334	3374	0,063	1063			
12	3820	0,063	1203	2679	0,063	844	1592	0,044	350	2812	0,079	1111			
14	3274	0,069	1130	2296	0,069	792	1364	0,049	334	2410	0,087	1048			
16	2865	0,076	1089	2009	0,076	764	1194	0,054	322	2109	0,096	1012			
18	2546	0,083	1057	1786	0,083	741	1061	0,058	308	1874	0,103	965			
20	2292	0,089	1020	1607	0,089	715	955	0,062	296	1687	0,111	936			
25	1833	0,101	926	1286	0,101	649	764	0,071	271	1350	0,126	850			

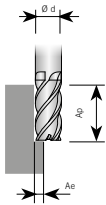
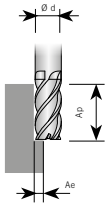
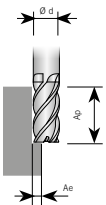
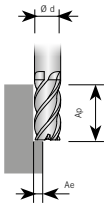

Rostfreier Stahl / Stainless steel 300 / Acier inoxydable 300				Rostfreier Stahl / Stainless steel 400 / Acier inoxydable 400				Rostfreier Stahl / Stainless steel PH / PH Acier inoxydable				Titan / Titanium / Titane			
1.4301(X5 CrNi 18 10) • 1.4436(X3 CrNiMo 17 13 3) • 1.4306(X2 CrNi 19 11) • 1.4435(X2 CrNiMo 18 14 3)				1.4005(X12 CrS 13) 1.4104(X14 CrMoS 17)				1.4594(27 CNU 1505)				Ti6Al4V • Ti5Al5V5Mo • Ti7Al4Mo			
Umfangsfraßen / Side cutting / Contournage				Umfangsfraßen / Side cutting / Contournage				Umfangsfraßen / Side cutting / Contournage				Umfangsfraßen / Side cutting / Contournage			
Ap 1,5 x d / Ae 0,3 x d				Ap 1,5 x d / Ae 0,3 x d				Ap 1,5 x d / Ae 0,3 x d				Ap 1,5 x d / Ae 0,3 x d			
Vc = 66 - 82 - 98 m/min				Vc = 94 - 117 - 140 m/min				Vc = 47 - 59 - 71 m/min				Vc = 55 - 69 - 83 m/min			
d	RPM	Fz	FEED	d	RPM	Fz	FEED	d	RPM	Fz	FEED	d	RPM	Fz	FEED
(mm)	(U/min)	(mm/Zahn)	(mm/min)	(mm)	(U/min)	(mm/Zahn)	(mm/min)	(mm)	(U/min)	(mm/Zahn)	(mm/min)	(mm)	(U/min)	(mm/Zahn)	(mm/min)
6	4350	0,030	653	6207	0,024	745	3130	0,03	470	3661	0,027	494			
8	3263	0,032	522	4655	0,025	582	2348	0,032	376	2745	0,029	398			
10	2610	0,038	496	3724	0,03	559	1878	0,038	357	2196	0,034	373			
12	2175	0,063	685	3104	0,046	714	1565	0,063	493	1830	0,057	522			
14	1864	0,065	606	2660	0,051	678	1341	0,065	436	1569	0,059	463			
16	1631	0,069	563	2328	0,054	628	1174	0,069	405	1373	0,062	426			
18	1450	0,070	508	2069	0,057	590	1043	0,07	365	1220	0,063	384			
20	1305	0,076	496	1862	0,061	568	939	0,076	357	1098	0,069	379			
25	1044	0,088	459	1490	0,071	529	751	0,088	331	879	0,079	347			

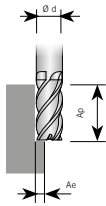
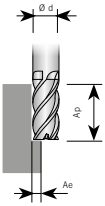
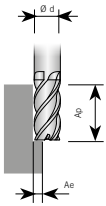
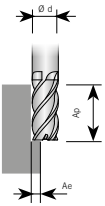

Die Tabellenwerte sind Richtwerte. Es kann notwendig sein, die Werte den jeweiligen Bearbeitungsumständen anzupassen. Bei Schlichtschnitten verwenden Sie reduzierte Vorschubgeschwindigkeiten und/oder höhere Drehzahlen (2% x d1). Bei härteren Materialien reduzieren Sie Geschwindigkeit und Vorschub.

The recommended cutting data are only approximate values. It may be necessary to adjust them to each individual machining application. Finish cuts typically require reduced feed rates and/or higher spindle speed, with radial width of 2% x d1 or less. Reduce speed and feed recommendations for materials harder than listed.

Les valeurs du tableau sont indicatives. Il peut être nécessaire de les adapter aux conditions d'usinage respectives. Pour les découpes de dégrossissage, vous utilisez des vitesses d'avance réduites et/ou des vitesses de rotation plus élevées (2% x d1). Avec des matériaux plus durs, vous réduisez la vitesse et la course avant.

**Hochtemperaturlegierungen**

High Temperature Alloys

Alliages à haute température

RENE

- INCONEL
- WASPALLOY
- HASTELLOY

**Umfangfräsen**

Side cutting

Contournage

Ap 1,5 x d / Ae 0,1 x d

Vc = 25 - 31 - 37 m/min

d (mm)	RPM (U/min)	Fz (mm/Zahn)	FEED (mm/min)
6	1645	0,021	173
8	1233	0,022	136
10	987	0,027	133
12	822	0,044	181
14	705	0,046	162
16	617	0,048	148
18	548	0,049	134
20	493	0,053	131
25	395	0,062	122

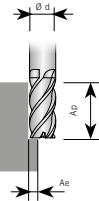

Die Tabellenwerte sind Richtwerte. Es kann notwendig sein, die Werte den jeweiligen Bearbeitungsumständen anzupassen. Bei Schlichtschnitten verwenden Sie reduzierte Vorschubgeschwindigkeiten und/oder höhere Drehzahlen (2% x d1). Bei härteren Materialien reduzieren Sie Geschwindigkeit und Vorschub.

The recommended cutting data are only approximate values. It may be necessary to adjust them to each individual machining application. Finish cuts typically require reduced feed rates and/or higher spindle speed, with radial width of 2% x d1 or less. Reduce speed and feed recommendations for materials harder than listed.

Les valeurs du tableau sont indicatives. Il peut être nécessaire de les adapter aux conditions d'usinage respectives. Pour les découpes de dégrossissage, vous utilisez des vitesses d'avance réduites et/ou des vitesses de rotation plus élevées (2% x d1). Avec des matériaux plus durs, vous réduisez la vitesse et la course avant.



Rostfreier Stahl Stainless steel 400 Acier inoxydable 400				Titan Titanium Titane			Hochtemperaturlegierungen High Temperature Alloys Alliages à haute température		
1.4005(X12 CrS 13) 1.4104(X14 CrMoS 17)				Ti6Al4V • Ti5Al5V5Mo • Ti7Al4Mo			Inconel		
Umfangsfräsen Side cutting Contournage				Umfangsfräsen Side cutting Contournage			Umfangsfräsen Side cutting Contournage		
Ap: 1,5 x d				Ap: 1 x d			Ap 1 x d		
Ae: ø6 - ø10: 0.15 x d ø12 - ø16: 0,10 x d ø20 - ø25: 0.05 x d				Ae: ø6 - ø10: 0.15 x d ø12 - ø16: 0,10 x d ø20 - ø25: 0.05 x d			Ae: 0,05 x d		
Vc = 64 - 80 - 96 m/min				Vc = 52 - 65 - 78 m/min			Vc = 32 - 40 - 48 m/min		
d	RPM	Fz	FEED	RPM	Fz	FEED	RPM	Fz	FEED
(mm)	(U/min)	(mm/Zahn)	(mm/min)	(U/min)	(mm/Zahn)	(mm/min)	(U/min)	(mm/Zahn)	(mm/min)
6	4244	0,025	531	3448	0,022	379	2122	0,020	212
8	3183	0,034	541	2586	0,031	401	1592	0,025	199
10	2546	0,041	522	2069	0,038	393	1273	0,037	236
12	2122	0,051	541	1724	0,046	397	1061	0,040	212
14	1819	0,057	518	1478	0,052	384	909	0,046	209
16	1592	0,063	501	1293	0,058	375	796	0,052	207
20	1273	0,081	516	1035	0,074	383	637	0,061	194
25	1019	0,091	463	828	0,084	348	509	0,068	173

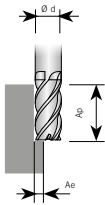
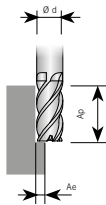
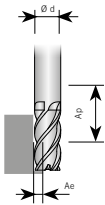

Die Tabellenwerte sind Richtwerte. Es kann notwendig sein, die Werte den jeweiligen Bearbeitungsumständen anzupassen. Bei Schlichtschnitten verwenden Sie reduzierte Vorschubgeschwindigkeiten und/oder höhere Drehzahlen (2% x d1). Bei härteren Materialien reduzieren Sie Geschwindigkeit und Vorschub.

The recommended cutting data are only approximate values. It may be necessary to adjust them to each individual machining application. Finish cuts typically require reduced feed rates and/or higher spindle speed, with radial width of 2% x d1 or less. Reduce speed and feed recommendations for materials harder than listed.

Les valeurs du tableau sont indicatives. Il peut être nécessaire de les adapter aux conditions d'usinage respectives. Pour les découpes de dégrossissage, vous utilisez des vitesses d'avance réduites et/ou des vitesses de rotation plus élevées (2% x d1). Avec des matériaux plus durs, vous réduisez la vitesse et la course avant.

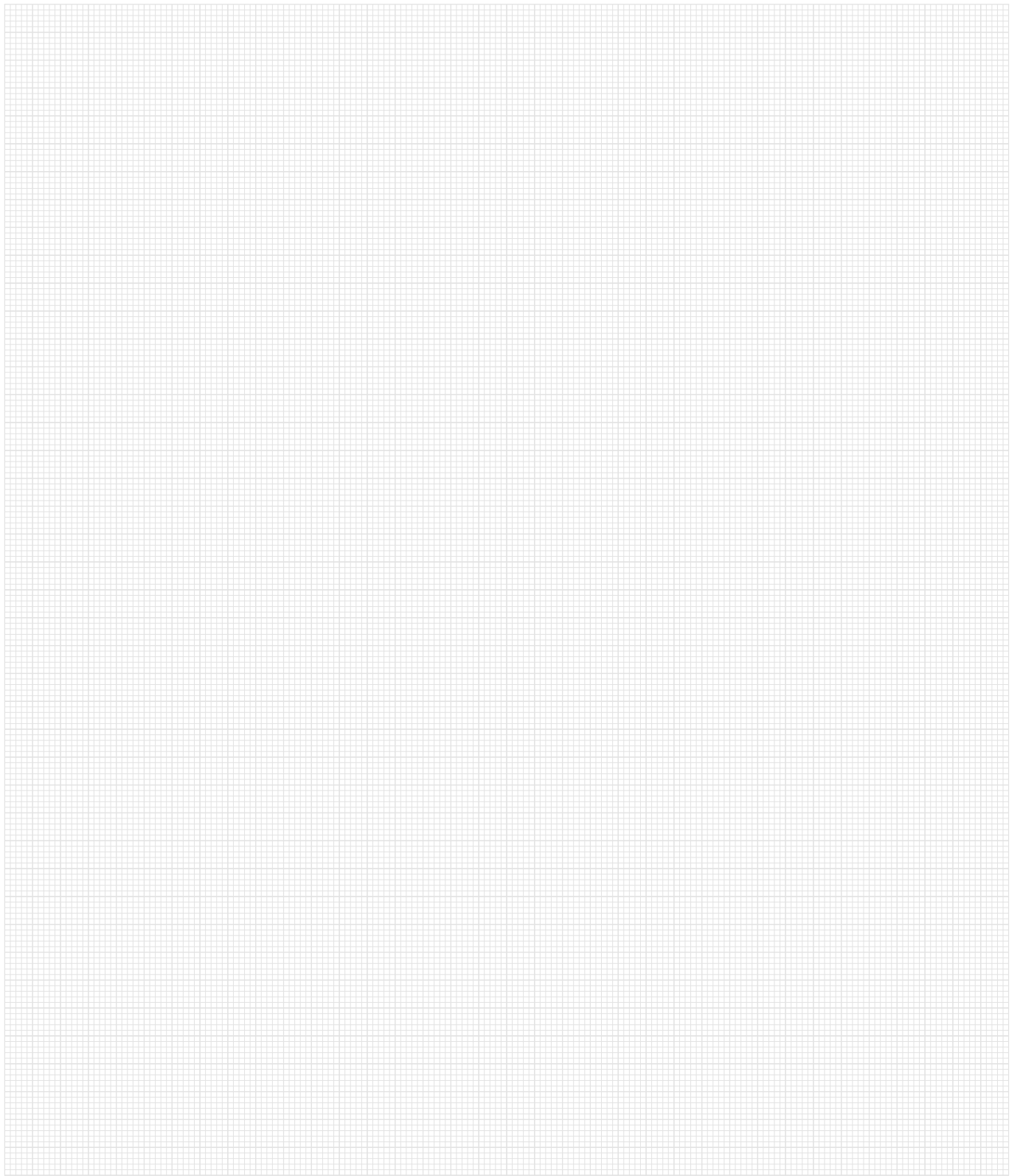

**Weitere Informationen finden Sie unter**  
*For more information see*  
**Pour plus d'informations**

**[www.arno.de](http://www.arno.de)**

# ARNO<sup>®</sup>

## WERKZEUGE

We have a passion for precision.

# AUSFÜHRUNG AFG

*Design AFG / Modèle AFG*

## **Ausgezeichnet für die Bearbeitung von Stählen und gehärteten Stählen.**

*Excellent for machining steel and hardened steel.  
Idéale pour l'usinage d'aciers et d'acier traités.*

**Nicht nur bei der Bearbeitung von legierten  
und unlegierten Stählen leisten die AFG-Fräser  
ganze Arbeit, sondern auch bei gehärteten  
Stählen (bis 50 HRC) und anderen zähen  
Werkstoffen. Für die Trocken-  
bearbeitung geeignet.**



*Not just for milling of alloy and non-alloy steel, but  
also for hard steel (up to 50 HRC) as well as other  
tough materials. Also suitable for dry machining.*

Les fraises AFG permettent non seulement l'usinage d'aciers alliés et non alliés,  
mais également les aciers trempés (jusqu'à 50 HRC) et autres matériaux fer-  
reux durs. Efficace pour l'usinage à sec

## AFG50120-...

2 Schneiden, kurze Ausführung / 2 flutes, short design / 2 dents, version courte

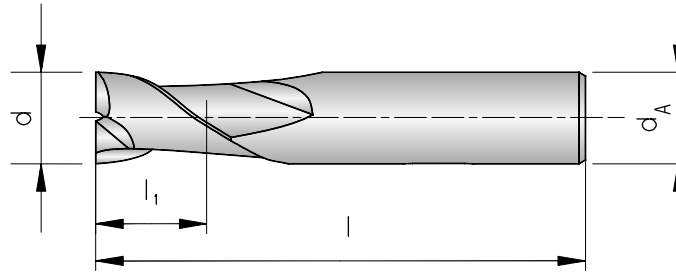

						PG 24
						beschichtet coated revêtu
Schaft DIN 6535HA Shank Tige	d -0,03	d <sub>A</sub> h6	l <sub>1</sub>	l	TiAIN	
AFG50120-020B	2	6	6	40	●	
AFG50120-030	3	6	8	45	●	
AFG50120-040	4	6	11	45	●	
AFG50120-050	5	6	13	50	●	
AFG50120-060	6	6	13	50	●	
AFG50120-080	8	8	19	60	●	
AFG50120-100	10	10	22	70	●	
AFG50120-120	12	12	26	75	●	
AFG50120-140	14	14	26	85	●	
AFG50120-160	16	16	32	100	●	
AFG50120-180	18	18	32	100	●	
AFG50120-200	20	20	38	105	●	
AFG50120-220	22	20	38	105	●	
AFG50120-250	25	25	45	120	●	

P	●
M	●
K	
N	
S	
H	

● **Hauptanwendung**  
Main application  
Application principale

○ **Nebenanwendung**  
Secondary application  
Application secondaire

Solid carbide end-mill  
Fraise carbure monobloc à tige

## AFG50121-...

2 Schneiden, lange Ausführung / 2 flutes, long design / 2 dents, version longue

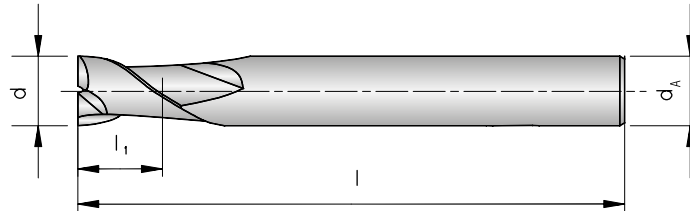

						PG 24
						beschichtet coated revêtu
Schaft DIN 6535HA Shank Tige	d -0,03	d <sub>A</sub> h6	l <sub>1</sub>	l		TiAlN
AFG50121-020	2	4	8	40		●
AFG50121-030	3	6	12	50		●
AFG50121-040	4	6	15	50		●
AFG50121-050	5	6	20	60		●
AFG50121-060	6	6	20	60		●
AFG50121-080	8	8	25	70		●
AFG50121-100	10	10	30	90		●
AFG50121-120	12	12	30	90		●
AFG50121-140	14	16	40	110		●
AFG50121-160	16	16	50	110		●
AFG50121-180	18	20	50	110		●
AFG50121-200	20	20	55	110		●
AFG50121-250	25	25	75	140		●

P	●
M	
K	
N	
S	
H	

● Hauptanwendung  
Main application  
Application principale

○ Nebenanwendung  
Secondary application  
Application secondaire

Solid carbide ball-nose end-mill  
Fraise carbure monobloc hémisphérique

## AFG50321-...

2 Schneiden, lange Ausführung / 2 flutes, long design / 2 dents, version longue

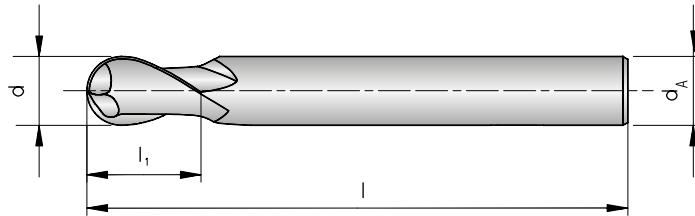

AFG

							PG 24
							beschichtet coated revêtu
Schaft DIN 6535HA Shank Tige	d -0,03	d <sub>A</sub> h6	l <sub>1</sub>	l	R	TiAlN	
AFG50321-020	2	6	5	50	1,0	●	
AFG50321-030	3	6	8	60	1,5	●	
AFG50321-040	4	6	8	70	2,0	●	
AFG50321-050	5	6	10	80	2,5	●	
AFG50321-060	6	6	12	90	3,0	●	
AFG50321-080	8	8	14	100	4,0	●	
AFG50321-100	10	10	18	100	5,0	●	
AFG50321-120	12	12	22	110	6,0	●	
AFG50321-140	14	14	26	110	7,0	●	
AFG50321-160	16	16	30	140	8,0	●	
AFG50321-180	18	18	34	140	9,0	●	
AFG50321-200	20	20	38	160	10,0	●	
AFG50321-250	25	25	50	180	12,5	●	

P	●
M	
K	
N	
S	
H	

● **Hauptanwendung**  
Main application  
Application principale  
○ **Nebenanwendung**  
Secondary application  
Application secondaire

Solid carbide ball-nose end-mill  
Fraise carbure monobloc hémisphérique

## AFG50322-...

2 Schneiden, mit konischem Schaftteil / 2 flutes, with taper neck / 2 dents, avec et tige conique

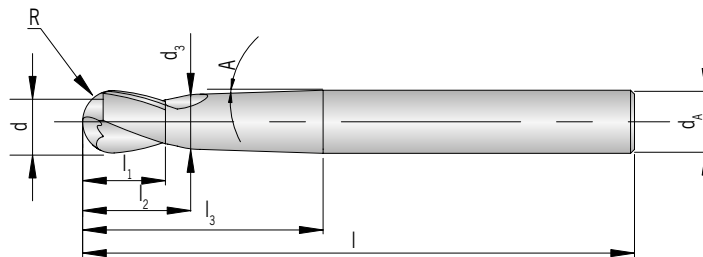

PG 24

beschichtet  
coated  
revêtu

Schaft DIN 6535HA Shank Tige	d -0,03	d <sub>A</sub> h6	d <sub>3</sub>	l <sub>1</sub>	l <sub>2</sub>	l <sub>3</sub>	l	R ± 0,01	A	TiAIN
AFG50322-010A	1	6	2,0	2	4	23	60	0,5	1,50°	●
AFG50322-010B	1	6	4,3	2	4	23	60	0,5	5,00°	●
AFG50322-010C	1	6	5,0	2	4	42	80	0,5	3,00°	●
AFG50322-020A	2	6	2,9	4	6	23	60	1,0	1,50°	●
AFG50322-020B	2	6	5,0	4	6	23	60	1,0	5,00°	●
AFG50322-020C	2	6	5,7	4	6	41	80	1,0	3,00°	●
AFG50322-030A	3	6	5,6	6	8	32	70	1,5	3,00°	●
AFG50322-030B	3	6	5,3	6	8	52	90	1,5	1,50°	●
AFG50322-040A	4	6	6,0	8	10	28	70	2,0	3,00°	●
AFG50322-040B	4	6	6,0	8	10	49	90	2,0	1,50°	●
AFG50322-050A	5	8	8,0	10	12	41	90	2,5	3,00°	●
AFG50322-050B	5	8	7,0	10	12	61	110	2,5	1,50°	●
AFG50322-060A	6	8	8,0	12	15	34	90	3,0	3,00°	●
AFG50322-060B	6	8	8,0	12	15	53	110	3,0	1,50°	●
AFG50322-080A	8	10	10,0	14	17	36	100	4,0	3,00°	●
AFG50322-080B	8	10	10,0	14	17	55	120	4,0	1,50°	●
AFG50322-100A	10	12	12,0	18	21	40	110	5,0	3,00°	●
AFG50322-100B	10	12	12,0	18	21	59	130	5,0	1,50°	●
AFG50322-120A	12	16	16,0	22	25	63	140	6,0	3,00°	●
AFG50322-120B	12	16	15,0	22	25	83	160	6,0	1,50°	●

P	●
M	
K	
N	
S	
H	

● Hauptanwendung  
Main application  
Application principale  
○ Nebenanwendung  
Secondary application  
Application secondaire

Solid carbide ball-nose end-mill  
Fraise carbure monobloc hémisphérique

## AFG52021-...

2 Schneiden, lange Ausführung (Schlitzfräsen) / 2 flutes, long design (Slotting) / 2 dents, version longue (fraise à rainer)

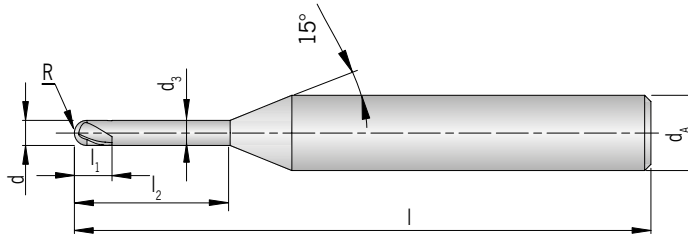

AFG

									PG 24
									beschichtet coated revêtu
Schaft DIN 6535HA Shank Tige	d -0,02	d <sub>A</sub> h6	d <sub>3</sub>	l <sub>1</sub>	l <sub>2</sub>	l	R ± 0,01	TITAIN	
AFG52021-004A	0,4	4	0,37	0,6	1	45	0,20	●	
AFG52021-004B	0,4	4	0,37	0,6	2	45	0,20	●	
AFG52021-004C	0,4	4	0,37	0,6	3	45	0,20	●	
AFG52021-005A	0,5	4	0,45	0,7	2	45	0,25	●	
AFG52021-005B	0,5	4	0,45	0,7	4	45	0,25	●	
AFG52021-005C	0,5	4	0,45	0,7	6	45	0,25	●	
AFG52021-005D	0,5	4	0,45	0,7	8	45	0,25	●	
AFG52021-006A	0,6	4	0,55	0,9	2	45	0,30	●	
AFG52021-006B	0,6	4	0,55	0,9	4	45	0,30	●	
AFG52021-006C	0,6	4	0,55	0,9	6	35	0,30	●	
AFG52021-006D	0,6	4	0,55	0,9	6	45	0,30	●	
AFG52021-006E	0,6	4	0,55	0,9	8	45	0,30	●	
AFG52021-008A	0,8	4	0,75	1,2	2	45	0,40	●	
AFG52021-008B	0,8	4	0,75	1,2	4	45	0,40	●	
AFG52021-008C	0,8	4	0,75	1,2	6	45	0,40	●	
AFG52021-008D	0,8	4	0,75	1,2	8	45	0,40	●	
AFG52021-008E	0,8	4	0,75	1,2	10	45	0,40	●	
AFG52021-010A	1,0	4	0,95	1,5	3	45	0,50	●	
AFG52021-010B	1,0	4	0,95	1,5	4	45	0,50	●	
AFG52021-010C	1,0	4	0,95	1,5	5	45	0,50	●	
AFG52021-010D	1,0	4	0,95	1,5	6	45	0,50	●	
AFG52021-010E	1,0	4	0,95	1,5	7	45	0,50	●	
AFG52021-010F	1,0	4	0,95	1,5	8	45	0,50	●	
AFG52021-010G	1,0	4	0,95	1,5	9	45	0,50	●	
AFG52021-010H	1,0	4	0,95	1,5	10	45	0,50	●	
AFG52021-010I	1,0	4	0,95	1,5	12	45	0,50	●	
AFG52021-010J	1,0	4	0,95	1,5	14	50	0,50	●	
AFG52021-010K	1,0	4	0,95	1,5	16	50	0,50	●	
AFG52021-010L	1,0	4	0,95	1,5	20	55	0,50	●	



Solid carbide ball-nose end-mill  
Fraise carbure monobloc hémisphérique

								PG 24
								beschichtet coated revêtu
Schaft DIN 6535HA Shank Tige	d -0,02	d <sub>A</sub> h6	d <sub>3</sub>	l <sub>1</sub>	l <sub>2</sub>	l	R ± 0,01	TIAIN
AFG52021-012A	1,2	4	1,15	1,8	8	45	0,60	●
AFG52021-012B	1,2	4	1,15	1,8	12	45	0,60	●
AFG52021-014A	1,4	4	1,35	2,1	8	45	0,70	●
AFG52021-014B	1,4	4	1,35	2,1	12	45	0,70	●
AFG52021-014C	1,4	4	1,35	2,1	16	50	0,70	●
AFG52021-015A	1,5	4	1,45	2,3	6	45	0,75	●
AFG52021-015B	1,5	4	1,45	2,3	8	45	0,75	●
AFG52021-015C	1,5	4	1,45	2,3	10	45	0,75	●
AFG52021-015D	1,5	4	1,45	2,3	12	45	0,75	●
AFG52021-015E	1,5	4	1,45	2,3	16	50	0,75	●
AFG52021-015F	1,5	4	1,45	2,3	20	55	0,75	●
AFG52021-016A	1,6	4	1,55	2,4	8	45	0,80	●
AFG52021-016B	1,6	4	1,55	2,4	12	45	0,80	●
AFG52021-016C	1,6	4	1,55	2,4	16	50	0,80	●
AFG52021-016D	1,6	4	1,55	2,4	20	55	0,80	●
AFG52021-018A	1,8	4	1,75	2,7	8	45	0,90	●
AFG52021-018B	1,8	4	1,75	2,7	12	45	0,90	●
AFG52021-018C	1,8	4	1,75	2,7	16	50	0,90	●
AFG52021-018D	1,8	4	1,75	2,7	20	55	0,90	●
AFG52021-020A	2,0	4	1,95	3,0	4	45	1,00	●
AFG52021-020B	2,0	4	1,95	3,0	6	45	1,00	●
AFG52021-020C	2,0	4	1,95	3,0	8	45	1,00	●
AFG52021-020D	2,0	4	1,95	3,0	10	45	1,00	●
AFG52021-020E	2,0	4	1,95	3,0	12	50	1,00	●
AFG52021-020F	2,0	4	1,95	3,0	14	50	1,00	●
AFG52021-020G	2,0	4	1,95	3,0	16	50	1,00	●
AFG52021-020H	2,0	4	1,95	3,0	20	55	1,00	●
AFG52021-020I	2,0	4	1,95	3,0	22	60	1,00	●
AFG52021-020J	2,0	4	1,95	3,0	25	60	1,00	●
AFG52021-020K	2,0	4	1,95	3,0	30	70	1,00	●
AFG52021-030A	3,0	6	2,85	4,5	8	50	1,50	●
AFG52021-030B	3,0	6	2,85	4,5	10	50	1,50	●
AFG52021-030C	3,0	6	2,85	4,5	12	50	1,50	●
AFG52021-030D	3,0	6	2,85	4,5	16	55	1,50	●
AFG52021-030E	3,0	6	2,85	4,5	20	60	1,50	●
AFG52021-030F	3,0	6	2,85	4,5	25	65	1,50	●
AFG52021-030G	3,0	6	2,85	4,5	30	70	1,50	●
AFG52021-030H	3,0	6	2,85	4,5	35	80	1,50	●
AFG52021-040A	4,0	6	3,85	6,0	10	60	2,00	●
AFG52021-040B	4,0	6	3,85	6,0	12	60	2,00	●
AFG52021-040C	4,0	6	3,85	6,0	16	60	2,00	●
AFG52021-040D	4,0	6	3,85	6,0	20	65	2,00	●
AFG52021-040E	4,0	6	3,85	6,0	25	70	2,00	●
AFG52021-040F	4,0	6	3,85	6,0	30	70	2,00	●
AFG52021-040G	4,0	6	3,85	6,0	35	80	2,00	●
AFG52021-040H	4,0	6	3,85	6,0	40	90	2,00	●
AFG52021-040I	4,0	6	3,85	6,0	45	90	2,00	●
AFG52021-040J	4,0	6	3,85	6,0	50	100	2,00	●
AFG52021-050A	5,0	6	4,85	7,5	16	60	2,50	●
AFG52021-050B	5,0	6	4,85	7,5	20	60	2,50	●
AFG52021-050C	5,0	6	4,85	7,5	25	70	2,50	●
AFG52021-050D	5,0	6	4,85	7,5	30	80	2,50	●
AFG52021-050E	5,0	6	4,85	7,5	35	80	2,50	●

AFG

Solid carbide ball-nose end-mill

Fraise carbure monobloc hémisphérique

								PG 24
								beschichtet coated revêtu
Schaft DIN 6535HA Shank Tige	d -0,02	d <sub>A</sub> h6	d <sub>3</sub>	l <sub>1</sub>	l <sub>2</sub>	l	R ± 0,01	TITAIN
AFG52021-060A	6,0	6	5,85	9,0	20	80	3,00	●
AFG52021-060B	6,0	6	5,85	9,0	30	90	3,00	●
AFG52021-060C	6,0	6	5,85	9,0	40	100	3,00	●
AFG52021-060D	6,0	6	5,85	9,0	50	110	3,00	●

P	●
M	
K	
N	
S	
H	

- **Hauptanwendung**  
Main application  
Application principale
- **Nebenanwendung**  
Secondary application  
Application secondaire

Solid carbide ball-nose end-mill  
Fraise carbure monobloc hémisphérique

## AFG51621-...

2 Schneiden, lange Ausführung / 2 flutes, long design / 2 dents, version longue

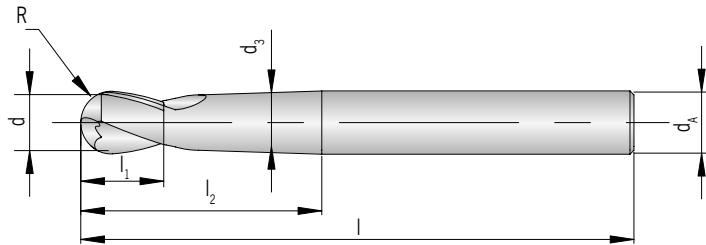

									PG 24
									beschichtet coated revêtu
Schaft DIN 6535HA Shank Tige	d -0,03	d <sub>A</sub> h6	d <sub>3</sub>	l <sub>1</sub>	l <sub>2</sub>	l	R ± 0,01	TiAlN	
AFG51621-030	3	6	2,5	2,3	30	80	1,5	●	
AFG51621-040	4	6	3,3	3,1	30	80	2,0	●	
AFG51621-050	5	6	4,1	3,9	38	80	2,5	●	
AFG51621-060	6	6	4,7	4,9	28	100	3,0	●	
AFG51621-080	8	8	6,5	6,3	33	100	4,0	●	
AFG51621-100	10	10	8,2	7,9	40	100	5,0	●	
AFG51621-120	12	12	9,8	9,5	49	100	6,0	●	

P	●
M	
K	
N	
S	
H	

● **Hauptanwendung**  
Main application  
Application principale

○ **Nebenanwendung**  
Secondary application  
Application secondaire

Solid carbide end-mill

Fraise carbure monobloc à tige

## AFG50134-... / AFG60134-...

3 Schneiden, Mini-Ausführung / 3 flutes, mini design / 3 dents, version mini

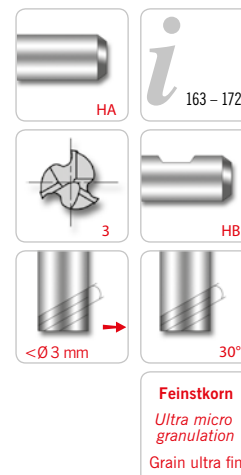
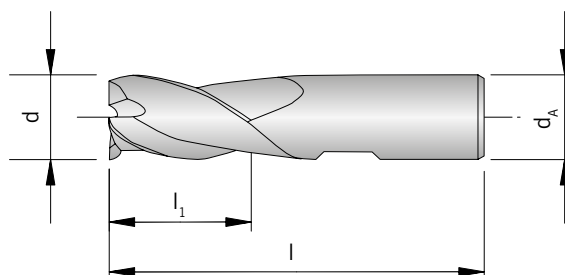

AFG

						PG 24
						beschichtet coated revêtu
Schaft DIN 6535HA Shank Tige	d -0,03	d <sub>A</sub> h6	l <sub>1</sub>	l		TiN
AFG50134-015	1,5	4	2	35	●	
AFG50134-020	2,0	4	4	35	●	

Zylinderschaft nach DIN 6535HA ohne Mitnahmefläche

Cylindrical shank to DIN 6535HA, no flat

Queue cylindrique conforme à la norme DIN 6535HA sans surface d'entraînement

● **Hauptanwendung**  
Main application  
Application principale

○ **Nebenanwendung**  
Secondary application  
Application secondaire

P	●
M	●
K	
N	
S	
H	

						PG 24
						beschichtet coated revêtu
Schaft DIN 6535HB Shank Tige	d -0,03	d <sub>A</sub> h6	l <sub>1</sub>	l		TiN
AFG60134-030	3	6	5	36	●	
AFG60134-040	4	6	7	38	●	
AFG60134-050	5	6	8	39	●	
AFG60134-060	6	6	8	39	●	
AFG60134-080	8	8	11	43	●	
AFG60134-100	10	10	13	50	●	
AFG60134-120	12	12	15	55	●	

● **Hauptanwendung**  
Main application  
Application principale

○ **Nebenanwendung**  
Secondary application  
Application secondaire

P	●
M	●
K	
N	
S	
H	

Solid carbide end-mill

Fraise carbure monobloc à tige

## AFG50745-...R...

4 Schneiden, mit Eckenradius / 4 flutes, with corner radius / 4 dents, avec rayon d'angle

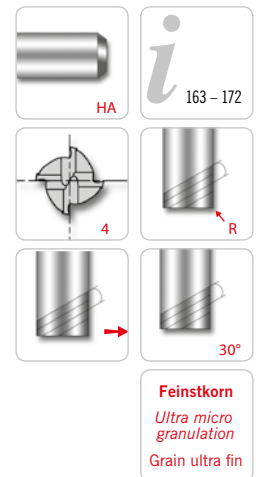
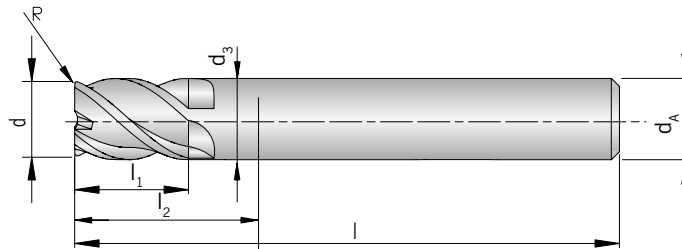

								PG 24
								beschichtet coated revêtu
Schaft DIN 6535HA Shank Tige	d -0,03	d <sub>A</sub> h6	d <sub>3</sub>	l <sub>1</sub>	l <sub>2</sub>	l	R ± 0,01	TiAIN
AFG50745-020R0,2	2,0	6	1,9	2,5	5	50	0,20	●
AFG50745-025R0,25	2,5	6	2,4	3,0	6	50	0,25	●
AFG50745-030R0,3	3,0	6	2,8	4,0	7	50	0,30	●
AFG50745-035R0,35	3,5	6	3,2	4,5	8	50	0,35	●
AFG50745-040R0,4	4,0	6	3,7	5,0	9	50	0,40	●
AFG50745-050R0,5	5,0	6	4,6	6,0	12	50	0,50	●
AFG50745-060R0,6	6,0	6	5,6	7,0	14	55	0,60	●
AFG50745-080R0,8	8,0	8	7,4	10,0	18	60	0,80	●
AFG50745-100R1,0	10,0	10	9,4	12,0	25	70	1,00	●
AFG50745-120R1,2	12,0	12	11,4	15,0	30	80	1,20	●
AFG50745-160R1,6	16,0	16	15,4	18,0	35	90	1,60	●

P	●
M	●
K	
N	
S	
H	

● Hauptanwendung  
Main application  
Application principale

○ Nebenanwendung  
Secondary application  
Application secondaire

Solid carbide end-mill  
Fraise carbure monobloc à tige

## AFG50140-...

4 Schneiden, kurze Ausführung / 4 flutes, short design / 4 dents, version courte

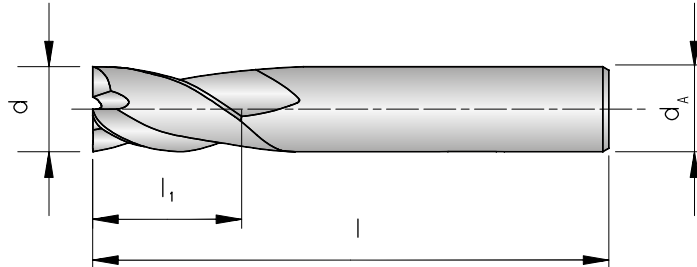

AFG

						PG 24
						beschichtet coated revêtu
Schaft DIN 6535HA Shank Tige	d -0,03	d <sub>A</sub> h6	l <sub>1</sub>	l	TiAIN	
AFG50140-020A	2,0	4	6	40	●	
AFG50140-020B	2,0	6	6	40	●	
AFG50140-025A	2,5	4	8	40	●	
AFG50140-030	3,0	6	8	45	●	
AFG50140-040	4,0	6	11	45	●	
AFG50140-050	5,0	6	13	50	●	
AFG50140-060	6,0	6	13	50	●	
AFG50140-080	8,0	8	19	60	●	
AFG50140-100	10,0	10	22	70	●	
AFG50140-120	12,0	12	26	75	●	
AFG50140-140	14,0	14	26	85	●	
AFG50140-160	16,0	16	32	100	●	
AFG50140-180	18,0	18	32	100	●	
AFG50140-200	20,0	20	38	105	●	
AFG50140-220	22,0	20	38	105	●	
AFG50140-250	25,0	25	45	120	●	

P	●
M	●
K	
N	
S	
H	

● Hauptanwendung  
Main application  
Application principale

○ Nebenanwendung  
Secondary application  
Application secondaire

Solid carbide end-mill  
Fraise carbure monobloc à tige

## AFG60140-...

4 Schneiden, kurze Ausführung / 4 flutes, short design / 4 dents, version courte

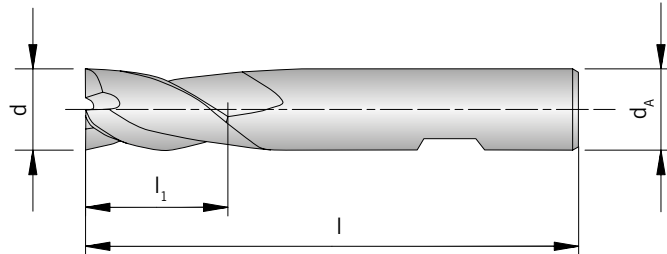

						PG 24
						beschichtet coated revêtu
Schaft DIN 6535HB Shank Tige	d -0,03	d <sub>A</sub> h6	l <sub>1</sub>	l	TiAIN	
AFG60140-020B	2	6	6	40	●	
AFG60140-030	3	6	8	45	●	
AFG60140-040	4	6	11	45	●	
AFG60140-050	5	6	13	50	●	
AFG60140-060	6	6	13	50	●	
AFG60140-080	8	8	19	60	●	
AFG60140-100	10	10	22	70	●	
AFG60140-120	12	12	26	75	●	
AFG60140-140	14	14	26	85	●	
AFG60140-160	16	16	32	100	●	
AFG60140-180	18	18	32	100	●	
AFG60140-200	20	20	38	105	●	

P	●
M	●
K	
N	
S	
H	

● **Hauptanwendung**  
Main application  
Application principale

○ **Nebenanwendung**  
Secondary application  
Application secondaire

Solid carbide end-mill

Fraise carbure monobloc à tige

## AFG50741-...R...

4 Schneiden, lange Ausführung, mit Eckenradius / 4 flutes, long design, with corner radius / 4 dents, version longue, avec rayon d'angle

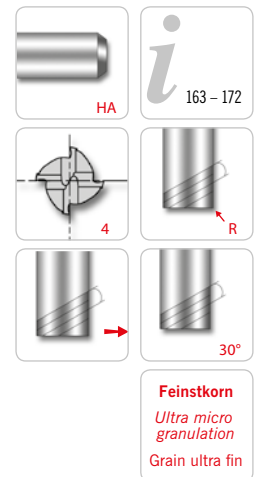
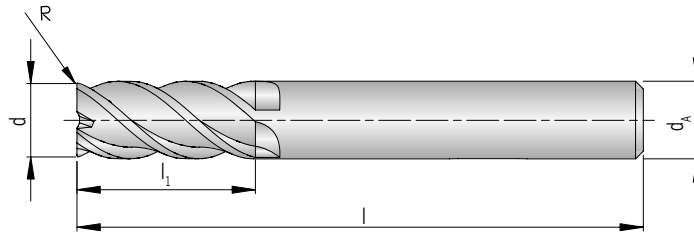

AFG

							PG 24
							beschichtet coated revêtu
Schaft DIN 6535HA Shank Tige	d -0,03	d <sub>A</sub> h6	l <sub>1</sub>	l	R ± 0,01	TiAIN	
AFG50741-030R0,3	3	6	12	50	0,3	●	
AFG50741-040R0,3	4	6	15	50	0,3	●	
AFG50741-040R0,5	4	6	15	50	0,5	●	
AFG50741-050R0,3	5	6	20	60	0,3	●	
AFG50741-050R0,5	5	6	20	60	0,5	●	
AFG50741-060R0,3	6	6	20	60	0,3	●	
AFG50741-060R0,5	6	6	20	60	0,5	●	
AFG50741-060R1,0	6	6	20	60	1,0	●	
AFG50741-080R0,3	8	8	25	70	0,3	●	
AFG50741-080R0,5	8	8	25	70	0,5	●	
AFG50741-080R1,0	8	8	25	70	1,0	●	
AFG50741-080R1,5	8	8	25	70	1,5	●	
AFG50741-080R2,0	8	8	25	70	2,0	●	
AFG50741-100R0,3	10	10	30	90	0,3	●	
AFG50741-100R0,5	10	10	30	90	0,5	●	
AFG50741-100R1,0	10	10	30	90	1,0	●	
AFG50741-100R1,5	10	10	30	90	1,5	●	
AFG50741-100R2,0	10	10	30	90	2,0	●	
AFG50741-120R0,5	12	12	30	90	0,5	●	
AFG50741-120R1,0	12	12	30	90	1,0	●	
AFG50741-120R1,5	12	12	30	90	1,5	●	
AFG50741-120R2,0	12	12	30	90	2,0	●	
AFG50741-160R0,5	16	16	50	110	0,5	●	
AFG50741-160R1,0	16	16	50	110	1,0	●	
AFG50741-160R1,5	16	16	50	110	1,5	●	
AFG50741-160R2,0	16	16	50	110	2,0	●	
AFG50741-200R0,5	20	20	55	110	0,5	●	
AFG50741-200R1,0	20	20	55	110	1,0	●	



Solid carbide end-mill

Fraise carbure monobloc à tige

							PG 24
							beschichtet coated revêtu
Schaft DIN 6535HA Shank Tige	d -0,03	d <sub>A</sub> h6	l <sub>1</sub>	l	R ± 0,01	TITAN	
AFG50741-200R1,5	20	20	55	110	1,5	●	
AFG50741-200R2,0	20	20	55	110	2,0	●	

P	●
M	
K	
N	
S	
H	

● **Hauptanwendung**  
Main application  
Application principale

○ **Nebenanwendung**  
Secondary application  
Application secondaire

Solid carbide end-mill  
Fraise carbure monobloc à tige

## AFG50141-...

4 Schneiden, lange Ausführung / 4 flutes, long design / 4 dents, version longue

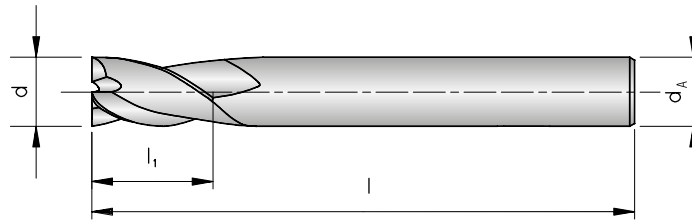

AFG

						PG 24
						beschichtet coated revêtu
Schaft DIN 6535HA Shank Tige	d -0,03	d <sub>A</sub> h6	l <sub>1</sub>	l		TiAlN
AFG50141-020	2	4	8	40		●
AFG50141-030	3	6	12	50		●
AFG50141-040	4	6	15	50		●
AFG50141-050	5	6	20	60		●
AFG50141-060	6	6	20	60		●
AFG50141-080	8	8	25	70		●
AFG50141-100	10	10	30	90		●
AFG50141-120	12	12	30	90		●
AFG50141-140	14	16	40	110		●
AFG50141-160	16	16	50	110		●
AFG50141-180	18	20	50	110		●
AFG50141-200	20	20	55	110		●
AFG50141-250	25	25	75	140		●

P	●
M	
K	
N	
S	
H	

● Hauptanwendung  
Main application  
Application principale  
○ Nebenanwendung  
Secondary application  
Application secondaire

Solid carbide end-mill  
Fraise carbure monobloc à tige

## AFG60141-...

4 Schneiden, lange Ausführung / 4 flutes, long design / 4 dents, version longue

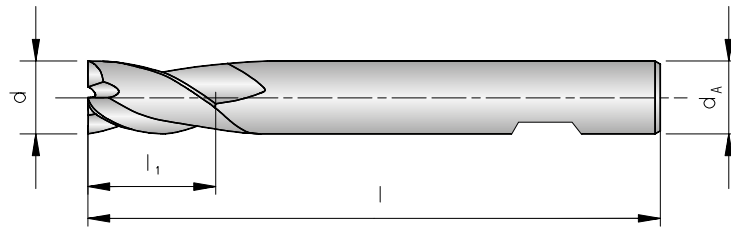

						PG 24
						beschichtet coated revêtu
Schaft DIN 6535HB Shank Tige	d -0,03	d <sub>A</sub> h6	l <sub>1</sub>	l	TiAlN	
AFG60141-030	3	6	12	50	●	
AFG60141-040	4	6	15	50	●	
AFG60141-050	5	6	20	60	●	
AFG60141-060	6	6	20	60	●	
AFG60141-080	8	8	25	70	●	
AFG60141-100	10	10	30	90	●	
AFG60141-120	12	12	30	90	●	
AFG60141-140	14	16	40	110	●	
AFG60141-160	16	16	50	110	●	
AFG60141-180	18	20	50	110	●	
AFG60141-200	20	20	55	110	●	
AFG60141-250	25	25	75	140	●	

P	●
M	
K	
N	
S	
H	

● **Hauptanwendung**  
Main application  
Application principale

○ **Nebenanwendung**  
Secondary application  
Application secondaire

Solid carbide end-mill  
Fraise carbure monobloc à tige

## AFG502.0-...

4 - 8 Schneiden, lange Ausführung / 4 - 8 flutes, long design / 4 - 8 dents, version longue

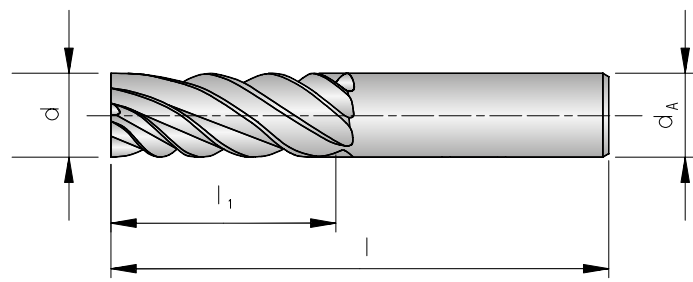

AFG

							PG 24
							beschichtet coated revêtu
Schaft DIN 6535HA Shank Tige	d -0,03	d <sub>A</sub> h6	l <sub>1</sub>	l	z	TITAIN	
AFG50240-040	4	6	11	57	4	●	
AFG50260-060	6	6	13	57	6	●	
AFG50260-080	8	8	19	63	6	●	
AFG50260-100	10	10	22	72	6	●	
AFG50260-120	12	12	26	83	6	●	
AFG50260-140	14	14	26	83	6	●	
AFG50260-160	16	16	32	92	6	●	
AFG50280-180	18	18	32	92	8	●	
AFG50280-200	20	20	38	104	8	●	
AFG50280-250	25	25	44	104	8	●	

P	●
M	
K	
N	
S	
H	

● Hauptanwendung  
Main application  
Application principale  
○ Nebenanwendung  
Secondary application  
Application secondaire

Solid carbide end-mill  
Fraise carbure monobloc à tige

## AFG602.0-...

6-8 Schneiden, extra lange Ausführung / 6-8 flutes, extra long design / 6-8 dents, version extra longue

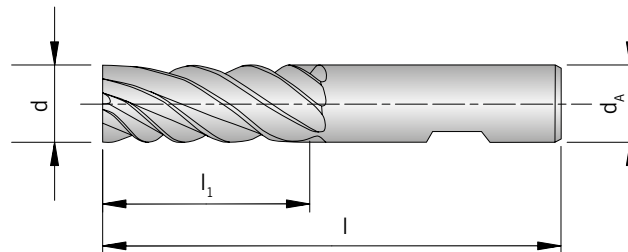

							PG 24
							beschichtet coated revêtu
Schaft DIN 6535HB Shank Tige	d -0,03	d <sub>A</sub> h6	l <sub>1</sub>	l	z	TiAIN	
AFG60240-040	4	6	11	57	4	●	
AFG60260-060	6	6	13	57	6	●	
AFG60260-070	7	8	16	63	6	●	
AFG60260-080	8	8	19	63	6	●	
AFG60260-100	10	10	22	72	6	●	
AFG60260-120	12	12	26	83	6	●	
AFG60260-140	14	14	26	83	6	●	
AFG60260-160	16	16	32	92	6	●	
AFG60280-180	18	18	32	92	8	●	
AFG60280-200	20	20	38	104	8	●	
AFG60280-250	25	25	44	104	8	●	

P	●
M	
K	
N	
S	
H	

● **Hauptanwendung**  
Main application  
Application principale

○ **Nebenanwendung**  
Secondary application  
Application secondaire

Solid carbide end-mill

Fraise carbure monobloc à tige

## AFG50861-...R...

6 Schneiden, lange Ausführung, mit Eckenradius / 6 flutes, long design, with corner radius / 6 tranchants, design long, avec rayon d'angle

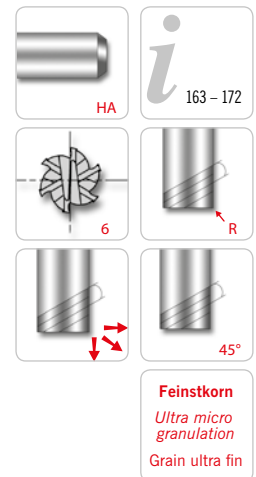
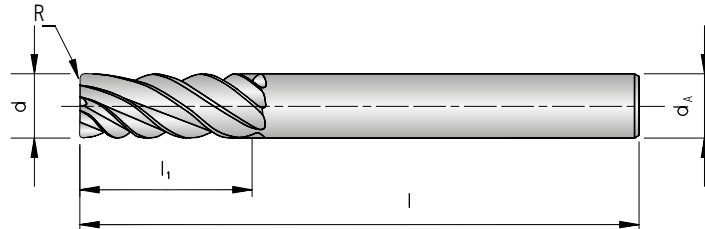

AFG

							PG 24
							beschichtet coated revêtu
Schaft DIN 6535HA Shank Tige	d -0,03	d <sub>A</sub> h6	l <sub>1</sub>	l	R ± 0,01	TiAIN	
AFG50861-060R0,5	6	6	13	70	0,5	●	
AFG50861-080R0,5	8	8	19	90	0,5	●	
AFG50861-100R0,5	10	10	22	100	0,5	●	
AFG50861-100R1,0	10	10	22	100	1,0	●	
AFG50861-120R0,5	12	12	26	110	0,5	●	
AFG50861-120R1,0	12	12	26	110	1,0	●	
AFG50861-160R1,0	16	16	32	130	1,0	●	
AFG50861-160R1,5	16	16	32	130	1,5	●	
AFG50861-200R1,0	20	20	38	140	1,0	●	
AFG50861-200R1,5	20	20	38	140	1,5	●	
AFG50861-200R2,0	20	20	38	140	2,0	●	

P	●
M	
K	
N	
S	
H	

● Hauptanwendung  
Main application  
Application principale  
○ Nebenanwendung  
Secondary application  
Application secondaire

Solid carbide end-mill  
Fraise carbure monobloc à tige

## AFG50262-...

6 Schneiden, extra lange Ausführung / 6 flutes, extra long design / 6 dents, version extra longue

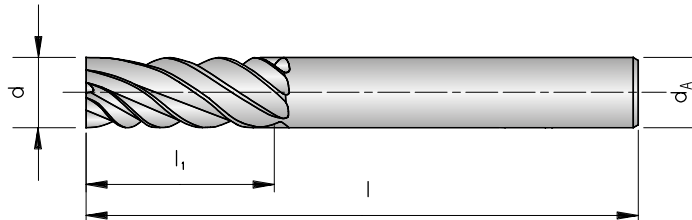

						PG 24
						beschichtet coated revêtu
Schaft DIN 6535HA Shank Tige	d -0,03	d <sub>A</sub> h6	l <sub>1</sub>	l	TITAIN	
AFG50262-060	6	6	26	70	●	
AFG50262-080	8	8	36	90	●	
AFG50262-100	10	10	46	100	●	
AFG50262-120	12	12	56	110	●	
AFG50262-160	16	16	66	130	●	
AFG50262-200	20	20	76	140	●	
AFG50262-250	25	25	92	180	●	

P	●
M	
K	
N	
S	
H	

● Hauptanwendung  
Main application  
Application principale

○ Nebenanwendung  
Secondary application  
Application secondaire

Solid carbide end-mill  
Fraise carbure monobloc à tige

## AFG60262-...

6 Schneiden, extra lange Ausführung / 6 flutes, extra long design / 6 dents, version extra longue

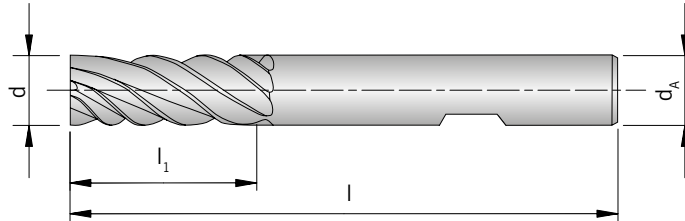

AFG

						PG 24
						beschichtet coated revêtu
Schaft DIN 6535HB Shank Tige	d -0,03	d <sub>A</sub> h6	l <sub>1</sub>	l		TiAIN
AFG60262-060	6	6	26	70		●
AFG60262-080	8	8	36	90		●
AFG60262-100	10	10	46	100		●
AFG60262-120	12	12	56	110		●
AFG60262-160	16	16	66	130		●
AFG60262-200	20	20	76	140		●
AFG60262-250	25	25	92	180		●

P	●
M	
K	
N	
S	
H	

● **Hauptanwendung**  
Main application  
Application principale

○ **Nebenanwendung**  
Secondary application  
Application secondaire



Solid carbide roughing end-mill  
Fraise carbure monobloc d'ébauche

## AFG606.0-...

3 - 5 Schneiden, kurze Ausführung / 3 - 5 flutes, short design / 3 - 5 dents, version courte

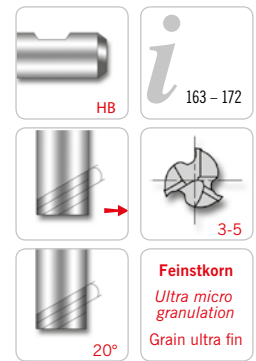
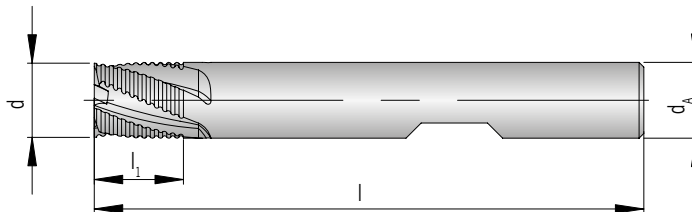

							PG 24
							beschichtet coated revêtu
Schaft DIN 6535HB Shank Tige	d h10	d <sub>A</sub> h6	l <sub>1</sub>	l	z	TiAIN	
AFG60630-060	6	6	7	54	3	●	
AFG60630-080	8	8	9	58	3	●	
AFG60640-100	10	10	14	66	4	●	
AFG60640-120	12	12	16	73	4	●	
AFG60640-140	14	14	18	75	4	●	
AFG60640-160	16	16	22	82	4	●	
AFG60640-180	18	18	24	84	4	●	
AFG60640-200	20	20	26	92	4	●	
AFG60650-250	25	25	25	110	5	●	

P	●
M	
K	
N	
S	
H	

● **Hauptanwendung**  
Main application  
Application principale

○ **Nebenanwendung**  
Secondary application  
Application secondaire

Solid carbide roughing end-mill  
Fraise carbure monobloc d'ébauche

## AFG606.1-...

3 - 5 Schneiden, lange Ausführung / 3 - 5 flutes, long design / 3 - 5 dents, version longue

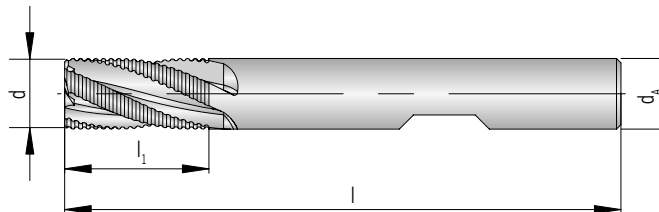
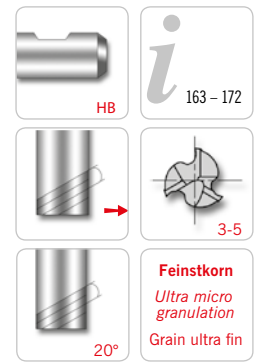

AFG

							PG 24
							beschichtet coated revêtu
Schaft DIN 6535HB Shank Tige	d h10	d <sub>A</sub> h6	l <sub>1</sub>	l	z	TiAIN	
AFG60631-040	4	6	11	57	3	●	
AFG60631-050	5	6	13	57	3	●	
AFG60631-060	6	6	16	57	3	●	
AFG60631-070	7	8	16	63	3	●	
AFG60631-080	8	8	16	63	3	●	
AFG60641-090	9	10	19	72	4	●	
AFG60641-100	10	10	22	72	4	●	
AFG60641-120	12	12	26	83	4	●	
AFG60641-140	14	14	26	83	4	●	
AFG60641-160	16	16	32	92	4	●	
AFG60641-180	18	18	32	92	4	●	
AFG60641-200	20	20	38	104	4	●	
AFG60651-250	25	25	45	121	5	●	

P	●
M	
K	
N	
S	
H	

● Hauptanwendung  
Main application  
Application principale  
○ Nebenanwendung  
Secondary application  
Application secondaire

Werkstoffgruppe	Gliederung der Werkstoffhauptgruppen und Kennbuchstaben		Brinell-Härte	Zugfestigkeit Rm (N/mm <sup>2</sup> )	Zerspanungsgruppe	Korrekturfaktor	Schnittgeschwindigkeit V <sub>c</sub> (m/min)	
							VHM	TAIN
P	Unlegierter Stahl	C ≤ 0,25 % geglüht	125	428	P1	1,2	100 - 170 - 240	
		C > 0,25 ... ≤ 0,55 % geglüht	190	639	P2	1,2	100 - 170 - 240	
		C > 0,25 ... ≤ 0,55 % vergütet	210	708	P3	1,2	90 - 155 - 220	
		C > 0,55 % geglüht	190	639	P4	1,2	100 - 170 - 240	
		C > 0,55 % vergütet	300	1013	P5	1,0	60 - 100 - 140	
		Automatenstahl (kurzspanend) geglüht	220	745	P6	1,2	100 - 170 - 240	
	Niedrig legierter Stahl	geglüht	175	591	P7	1,2	90 - 145 - 200	
		vergütet	300	1013	P8	1,0	90 - 145 - 200	
		vergütet	380	1282	P9	0,8	60 - 90 - 120	
		vergütet	430	1477	P10	0,8	60 - 90 - 120	
	Hochlegierter Stahl und hochlegierter Werkzeugstahl	geglüht	200	675	P11	1,2	90 - 145 - 200	
		gehärtet und angelassen	300	1013	P12	1,0	80 - 110 - 140	
		gehärtet und angelassen	400	1361	P13	0,8	60 - 85 - 110	
	Nichtrostender Stahl	ferritisch / martensitisch, geglüht	200	675	P14	1,0	50 - 85 - 120	
martensitisch, vergütet		330	1114	P15	0,9	30 - 55 - 80		
M	Nichtrostender Stahl	austenitisch, abgeschreckt	200	675	M1	1,0	60 - 90 - 120	
		austenitisch, ausscheidungsgehärtet (PH)	300	1013	M2	0,9	30 - 55 - 80	
		austenitisch-ferritisch, Duplex	230	778	M3	1,0	50 - 85 - 120	
K	Temperguss	ferritisch	200	675	K1		-	
		perrlitisch	260	867	K2		-	
	Grauguss	niedrige Festigkeit	180	602	K3		-	
		hohe Festigkeit / austenitisch	245	825	K4		-	
	Gusseisen mit Kugelgraphit	ferritisch	155	518	K5		-	
		perrlitisch	265	885	K6		-	
	GGV (CGI)		200	675	K7		-	
N	Aluminium-Knetlegierungen	nicht aushärtbar	30	-	N1		-	
		aushärtbar, ausgehärtet	100	343	N2		-	
	Aluminium-Gusslegierungen	≤ 12 % Si, nicht aushärtbar	75	260	N3		-	
		≤ 12 % Si, aushärtbar, ausgehärtet	90	314	N4		-	
	Magnesiumlegierungen	> 12 % Si, nicht aushärtbar	130	447	N5		-	
			70	250	N6		-	
	Kupfer und Kupferlegierungen (Bronze / Messing)	unlegiert, Elektrolytkupfer	100	343	N7		-	
		Messing, Bronze, Rotguss	90	314	N8		-	
		Cu-Legierung, kurzspanend	110	382	N9		-	
		hochfest, Ampco	300	1013	N10		-	
Nichtmetallische Werkstoffe	Thermoplaste (ohne abrasive Füllstoffe)	-	-	N11		-		
	Duroplaste (ohne abrasive Füllstoffe)	-	-	N12		-		
	Kunststoff glasfaserverstärkt GFRP	-	-	N13		-		
	Kunststoff kohlefaserverstärkt CFRP	-	-	N14		-		
	Kunststoff aramidfaserverstärkt AFRP	-	-	N15		-		
	Graphit (technisch)	80 Shore	-	N16		-		
S	Warmfeste Legierungen	Fe-Basis geglüht	200	675	S1		-	
		ausgehärtet	280	943	S2		-	
		geglüht	250	839	S3		-	
		Ni- oder Co-Basis ausgehärtet	350	1177	S4		-	
		gegossen	320	1076	S5		-	
	Titanlegierungen	Reintitan	200	675	S6		-	
		α- und β-Legierungen, ausgehärtet	375	1262	S7		-	
		β-Legierungen	410	1396	S8		-	
	Wolframlegierungen		300	1013	S9		-	
	Molybdänlegierungen		300	1013	S10		-	
H	Gehärteter Stahl	gehärtet und angelassen	50 HRC	-	H1	0,7	20 - 70 - 120	
		gehärtet und angelassen	55 HRC	-	H2	0,7	20 - 70 - 120	
		gehärtet und angelassen	60 HRC	-	H3	1,1	12 - 36 - 60	
	Gehärtetes Gusseisen	gehärtet und angelassen	55 HRC	-	H4	0,7	20 - 70 - 120	

Die Tabellenwerte sind Richtwerte. Es kann notwendig sein, die Werte den jeweiligen Bearbeitungsumständen anzupassen.

Material group	Structure of the material groups and identification letters		Brinell hardness HB	Tensile strength Rm (N/mm <sup>2</sup> )	Chipping group	Correction factor	Cutting speed V <sub>c</sub> (m/min)	
							VHM	TAIN
P	Unalloyed steel	C ≤ 0.25 % annealed	125	428	P1	1,2	100 - 170 - 240	
		C > 0.25 ... ≤ 0.55 % annealed	190	639	P2	1,2	100 - 170 - 240	
		C > 0.25 ... ≤ 0.55 % hardened and tempered	210	708	P3	1,2	90 - 155 - 220	
		C > 0.55 % annealed	190	639	P4	1,2	100 - 170 - 240	
		C > 0.55 % hardened and tempered	300	1013	P5	1,0	60 - 100 - 140	
		Machining steel (short-chipping) tempered	220	745	P6	1,2	100 - 170 - 240	
	Low alloyed steel	annealed	175	591	P7	1,2	90 - 145 - 200	
		hardened and tempered	300	1013	P8	1,0	90 - 145 - 200	
		hardened and tempered	380	1282	P9	0,8	60 - 90 - 120	
		hardened and tempered	430	1477	P10	0,8	60 - 90 - 120	
	High alloyed steel and high alloyed tool steel	annealed	200	675	P11	1,2	90 - 145 - 200	
		hardened	300	1013	P12	1,0	80 - 110 - 140	
		hardened	400	1361	P13	0,8	60 - 85 - 110	
	Stainless steel	ferritic / martensitic, annealed	200	675	P14	1,0	50 - 85 - 120	
		martensitic, hardened and tempered	330	1114	P15	0,9	30 - 55 - 80	
M	Stainless steel	austenitic, chilled	200	675	M1	1,0	60 - 90 - 120	
		austenitic, precipitation-hardened (PH)	300	1013	M2	0,9	30 - 55 - 80	
		austenitic-ferritic, Duplex	230	778	M3	1,0	50 - 85 - 120	
K	Malleable cast iron	ferritic	200	675	K1		-	
		pearlitic	260	867	K2		-	
	Cast iron	low tensile strength	180	602	K3		-	
		high tensile strength / austenitic	245	825	K4		-	
	Cast iron with nodular graphite	ferritic	155	518	K5		-	
		pearlitic	265	885	K6		-	
GGV (CGI)		200	675	K7		-		
N	Aluminium alloys long chipping	not heat treatable	30	-	N1		-	
		heat treatable, heat treated	100	343	N2		-	
	Casted aluminium alloys	≤ 12 % Si, not heat treatable	75	260	N3		-	
		≤ 12 % Si, aushärtbar, ausgehärtet	90	314	N4		-	
		> 12 % Si, not heat treatable	130	447	N5		-	
	Magnesium alloys		70	250	N6		-	
	Copper and copper alloys (Brass / Bronze)	Unalloyed, elektrolyte copper	100	343	N7		-	
		Brass, Bronze	90	314	N8		-	
		Cu-alloys, short-chipping	110	382	N9		-	
		High-tensile, Ampco	300	1013	N10		-	
Non-ferrous materials	Lead alloys (without abrasive filling material)	-	-	N11		-		
	Duroplastic (without abrasive filling material)	-	-	N12		-		
	Plastic glas fibre reinforced GFRP	-	-	N13		-		
	Plastic carbon fibre reinforced CFRP	-	-	N14		-		
	Plastic aramid fibre reinforced AFRP	-	-	N15		-		
	Graphite (tech.)	80 Shore	-	N16		-		
S	High temperature resistant alloys	Fe-Basis	annealed	200	675	S1		-
			heat treated	280	943	S2		-
		Ni- or Co-alloyed	annealed	250	839	S3		-
			heat treated	350	1177	S4		-
			casting	320	1076	S5		-
	Titanium alloys	Pure titan	200	675	S6		-	
		α- and β-alloys, heat treated	375	1262	S7		-	
		β-alloys	410	1396	S8		-	
	Wolfram alloys		300	1013	S9		-	
	Molybdän alloys		300	1013	S10		-	
H	Hardened steel	hardened	50 HRC	-	H1	0,7	20 - 70 - 120	
		hardened	55 HRC	-	H2	0,7	20 - 70 - 120	
		hardened	60 HRC	-	H3	1,1	12 - 36 - 60	
	Hardened cast iron	hardened	55 HRC	-	H4	0,7	20 - 70 - 120	

The recommended cutting data are only approximate values. It may be necessary to adjust them to each individual machining application.

ISO	Matériaux	Dureté Brinell	Résistance (N/mm <sup>2</sup> )	Groupe d'usinage	facteur de correction	Vitesse de coupe Vc (m/min)	
						VHM	TAIN
P	Acier non allié	C ≤ 0,25 % recuit	125	428	P1	1,2	100 - 170 - 240
		C > 0,25 ... ≤ 0,55 % recuit	190	639	P2	1,2	100 - 170 - 240
		C > 0,25 ... ≤ 0,55 % traité	210	708	P3	1,2	90 - 155 - 220
		C > 0,55 % recuit	190	639	P4	1,2	100 - 170 - 240
		C > 0,55 % traité	300	1013	P5	1,0	60 - 100 - 140
		Aciers de décolletage (à copeaux courts) recuit	220	745	P6	1,2	100 - 170 - 240
	Acier faiblement allié	recuit	175	591	P7	1,2	90 - 145 - 200
		traité	300	1013	P8	1,0	90 - 145 - 200
		traité	380	1282	P9	0,8	60 - 90 - 120
		traité	430	1477	P10	0,8	60 - 90 - 120
	Acier allié et acier outil allié	recuit	200	675	P11	1,2	90 - 145 - 200
		trempe et revenu	300	1013	P12	1,0	80 - 110 - 140
		trempe et revenu	400	1361	P13	0,8	60 - 85 - 110
	Acier inox	ferritique, martensitique, recuit	200	675	P14	1,0	50 - 85 - 120
martensitique, traité		330	1114	P15	0,9	30 - 55 - 80	
M	Acier inox	austénitique	200	675	M1	1,0	60 - 90 - 120
		austénitique	300	1013	M2	0,9	30 - 55 - 80
		austénitique-ferritique, Duplex	230	778	M3	1,0	50 - 85 - 120
K	Fonte malléable	ferritique	200	675	K1		-
		perlitique	260	867	K2		-
	Fonte grise	faible résistance	180	602	K3		-
		haute résistance / austénitique	245	825	K4		-
	Fonte à Graphite sphéroïdale	ferritique	155	518	K5		-
		perlitique	265	885	K6		-
GGV (CGI)		200	675	K7		-	
N	Alliages de fonderie d'aluminium	ne pouvant pas subir un durcissement	30	-	N1		-
		pouvant subir un durcissement, durci	100	343	N2		-
	Alliage de fonte d'aluminium	≤ 12 % Si, ne pouvant pas subir de durcissement	75	260	N3		-
		≤ 12 % Si, pouvant subir un durcissement, durci	90	314	N4		-
		> 12 % Si, ne pouvant pas subir de durcissement	130	447	N5		-
	Alliage de Magnésium		70	250	N6		-
	Cuivre et alliage de cuivre (bronze / laiton)	non allié, cuivre électrolytique	100	343	N7		-
		Laiton, bronze, fonte rouge	90	314	N8		-
		Alliage de cuivre à copeaux courts	110	382	N9		-
		forte résistance, Ampco	300	1013	N10		-
Matériaux non métalliques	Thermoplaste (sans agents de charge abrasives)	-	-	N11		-	
	Duroplaste (sans agents de charge abrasives)	-	-	N12		-	
	Matière plastique renforcée de fibres de verre GFRP	-	-	N13		-	
	Matière plastique renforcé composite CFRP	-	-	N14		-	
	Plastique renforcé fibre aramide AFRP	-	-	N15		-	
	Graphite	80 Shore	-	N16		-	
S	Alliages réfractaires	à base de Fe recuit	200	675	S1		-
		à base de Fe durci	280	943	S2		-
		à base Ni ou Co recuit	250	839	S3		-
		à base Ni ou Co durci	350	1177	S4		-
		à base Ni ou Co jeter	320	1076	S5		-
	Alliage de titane	Titane pur	200	675	S6		-
		Alliages Alpha + Beta, trempé	375	1262	S7		-
		Alliages Beta	410	1396	S8		-
	Alliage de tungstène		300	1013	S9		-
	Alliage de molybdène		300	1013	S10		-
H	Acier trempé	trempe et revenu	50 HRC	-	H1	0,7	20 - 70 - 120
		trempe et revenu	55 HRC	-	H2	0,7	20 - 70 - 120
		trempe et revenu	60 HRC	-	H3	1,1	12 - 36 - 60
	Fonte durci	trempe et revenu	55 HRC	-	H4	0,7	20 - 70 - 120

Les valeurs du tableau sont indicatives. Il peut être nécessaire de les adapter aux conditions d'usinage respectives.

## Vorschub pro Zahn bei einer radialen Zustellung von 0,2 – 0,3 mm

Feed per tooth with radial depth of cut from 0,2 – 0,3 mm

Avance par dent avec un engagement radial de 0,2 – 0,3 mm

≤ 40 HRC

Ø d <sub>1</sub> [mm]	Korrekturfaktor / Correction factor / Facteur de correction									
	1	0,7	0,8	0,9	1,1	1,2	1,5	1,6	1,8	1,9
1	0,004	0,003	0,003	0,004	0,004	0,005	0,006	0,006	0,007	0,008
2	0,008	0,006	0,006	0,007	0,009	0,010	0,012	0,013	0,014	0,015
3	0,012	0,008	0,010	0,011	0,013	0,014	0,018	0,019	0,022	0,023
4	0,016	0,011	0,013	0,014	0,018	0,019	0,024	0,026	0,029	0,030
5	0,020	0,014	0,016	0,018	0,022	0,024	0,030	0,032	0,036	0,038
6	0,024	0,017	0,019	0,022	0,026	0,029	0,036	0,038	0,043	0,046
8	0,032	0,022	0,026	0,029	0,035	0,038	0,048	0,051	0,058	0,061
10	0,040	0,028	0,032	0,036	0,044	0,048	0,060	0,064	0,072	0,076
12	0,048	0,034	0,038	0,043	0,053	0,058	0,072	0,077	0,086	0,091
14	0,056	0,039	0,045	0,050	0,062	0,067	0,084	0,090	0,101	0,106
16	0,064	0,045	0,051	0,058	0,070	0,077	0,096	0,102	0,115	0,122
18	0,072	0,050	0,058	0,065	0,079	0,086	0,108	0,115	0,130	0,137
20	0,080	0,056	0,064	0,072	0,088	0,096	0,120	0,128	0,144	0,152
22	0,090	0,060	0,070	0,080	0,095	0,110	0,130	0,140	0,160	0,170
25	0,100	0,070	0,080	0,090	0,110	0,120	0,150	0,160	0,180	0,190

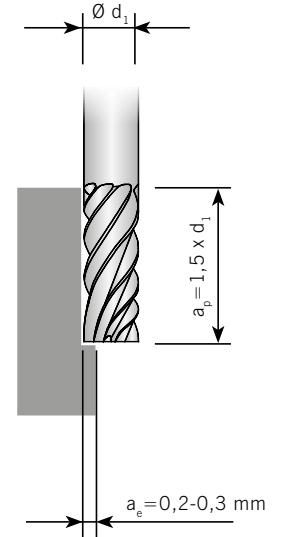

## Vorschub pro Zahn bei einer radialen Zustellung 10% vom Schneidendurchmesser (Ø d<sub>1</sub>) ≤ 40 HRC

Feed per tooth with radial depth of cut of 10% of the cutter (Ø d<sub>1</sub>)

Avance par dent avec un engagement radial de 10 % du diamètre de coupe (Ø d<sub>1</sub>)

Ø d <sub>1</sub> [mm]	Korrekturfaktor / Correction factor / Facteur de correction									
	1	0,7	0,8	0,9	1,1	1,2	1,5	1,6	1,8	1,9
1	0,003	0,002	0,002	0,003	0,003	0,004	0,005	0,005	0,005	0,006
2	0,008	0,006	0,006	0,007	0,009	0,010	0,012	0,013	0,014	0,015
3	0,012	0,008	0,010	0,011	0,013	0,014	0,018	0,019	0,022	0,023
4	0,014	0,010	0,011	0,013	0,015	0,017	0,021	0,022	0,025	0,027
5	0,017	0,012	0,014	0,015	0,019	0,020	0,026	0,027	0,031	0,032
6	0,020	0,014	0,016	0,018	0,022	0,024	0,030	0,032	0,036	0,038
8	0,027	0,019	0,022	0,024	0,030	0,032	0,041	0,043	0,049	0,051
10	0,033	0,023	0,026	0,030	0,036	0,040	0,050	0,053	0,059	0,063
12	0,040	0,028	0,032	0,036	0,044	0,048	0,060	0,064	0,072	0,076
14	0,047	0,033	0,038	0,042	0,052	0,056	0,071	0,075	0,085	0,089
16	0,053	0,037	0,042	0,048	0,058	0,064	0,080	0,085	0,095	0,101
18	0,060	0,042	0,048	0,054	0,066	0,072	0,090	0,096	0,108	0,114
20	0,067	0,047	0,054	0,060	0,074	0,080	0,101	0,107	0,121	0,127
25	0,083	0,058	0,066	0,075	0,091	0,100	0,125	0,133	0,149	0,158

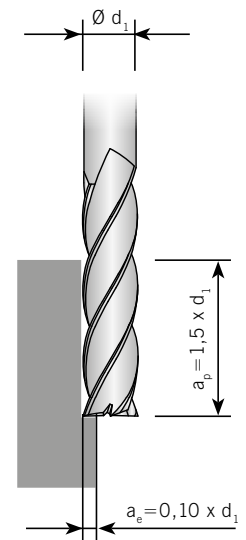

**Achtung:** Korrekturfaktor aus der Tabelle "Schnittgeschwindigkeiten" entnehmen.  
Korrekturfaktor -> 1,1 bei  $a_p = 1 \times d_1$  -> 1,2 bei  $a_p = 0,5 \times d_1$

Attention: Take the correction factor from the table "Cutting speeds".  
Correction factor -> 1,1 with  $a_p = 1 \times d_1$  -> 1,2 with  $a_p = 0,5 \times d_1$

Attention: Prenez le facteur de correction du tableau «Vitesse de coupe».  
Facteur de correction -> 1,1 pour  $a_p = 1 \times d_1$  -> 1,2 pour  $a_p = 0,5 \times d_1$

**Vorschub pro Zahn bei einer radialen Zustellung 20% vom Schneidendurchmesser ( $\varnothing d_1$ )  $\leq 40$  HRC**

Feed per tooth with radial depth of cut of 20% of the cutter ( $\varnothing d_1$ )

Avance par dent avec un engagement radial de 20 % du diamètre de coupe ( $\varnothing d_1$ )

$\varnothing d_1$ [mm]	Korrekturfaktor / Correction factor / Facteur de correction									
	1	0,7	0,8	0,9	1,1	1,2	1,5	1,6	1,8	1,9
1	0,002	0,001	0,001	0,001	0,002	0,002	0,003	0,003	0,003	0,003
2	0,005	0,003	0,004	0,004	0,005	0,006	0,007	0,008	0,009	0,009
3	0,008	0,005	0,006	0,007	0,008	0,009	0,012	0,012	0,014	0,015
4	0,010	0,007	0,008	0,009	0,011	0,012	0,015	0,016	0,018	0,019
5	0,013	0,009	0,010	0,011	0,014	0,015	0,019	0,020	0,023	0,024
6	0,015	0,010	0,012	0,013	0,016	0,018	0,022	0,024	0,027	0,028
8	0,020	0,014	0,016	0,018	0,022	0,024	0,030	0,032	0,036	0,038
10	0,025	0,017	0,020	0,022	0,027	0,030	0,037	0,040	0,045	0,047
12	0,030	0,021	0,024	0,027	0,033	0,036	0,045	0,048	0,054	0,057
14	0,035	0,024	0,028	0,031	0,038	0,042	0,052	0,056	0,063	0,066
16	0,040	0,028	0,032	0,036	0,044	0,048	0,060	0,064	0,072	0,076
18	0,045	0,031	0,036	0,040	0,049	0,054	0,067	0,072	0,081	0,085
20	0,050	0,035	0,040	0,045	0,055	0,060	0,075	0,080	0,090	0,095
22	0,055	0,040	0,045	0,050	0,060	0,065	0,080	0,090	0,100	0,100
25	0,063	0,044	0,050	0,056	0,069	0,075	0,094	0,100	0,113	0,119

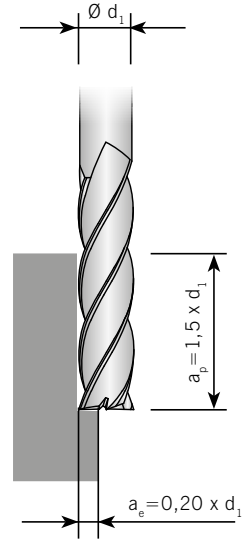

AFG

**Vorschub pro Zahn bei einer radialen Zustellung 40% vom Schneidendurchmesser ( $\varnothing d_1$ )  $\leq 40$  HRC**

Feed per tooth with radial depth of cut of 40% of the cutter ( $\varnothing d_1$ )

Avance par dent avec un engagement radial de 40 % du diamètre de coupe ( $\varnothing d_1$ )

$\varnothing d_1$ [mm]	Korrekturfaktor / Correction factor / Facteur de correction									
	1	0,7	0,8	0,9	1,1	1,2	1,5	1,6	1,8	1,9
1	0,001	0,001	0,001	0,001	0,001	0,001	0,002	0,002	0,002	0,003
2	0,004	0,002	0,003	0,003	0,004	0,004	0,006	0,006	0,007	0,007
3	0,006	0,004	0,005	0,005	0,007	0,007	0,009	0,010	0,011	0,012
4	0,008	0,005	0,006	0,007	0,008	0,009	0,012	0,012	0,014	0,015
5	0,010	0,007	0,008	0,009	0,011	0,012	0,015	0,016	0,018	0,019
6	0,012	0,008	0,009	0,010	0,013	0,014	0,018	0,019	0,021	0,022
8	0,016	0,011	0,012	0,014	0,017	0,019	0,024	0,025	0,028	0,030
10	0,020	0,014	0,016	0,018	0,022	0,024	0,030	0,032	0,036	0,038
12	0,024	0,016	0,019	0,021	0,026	0,028	0,036	0,038	0,043	0,045
14	0,028	0,019	0,022	0,025	0,030	0,033	0,042	0,044	0,050	0,053
16	0,032	0,022	0,025	0,028	0,035	0,038	0,048	0,051	0,057	0,060
18	0,036	0,025	0,028	0,032	0,039	0,043	0,054	0,057	0,064	0,068
20	0,040	0,028	0,032	0,036	0,044	0,048	0,060	0,064	0,072	0,076
22	0,045	0,030	0,035	0,040	0,045	0,050	0,065	0,070	0,080	0,085
25	0,050	0,035	0,040	0,045	0,055	0,060	0,075	0,080	0,090	0,095

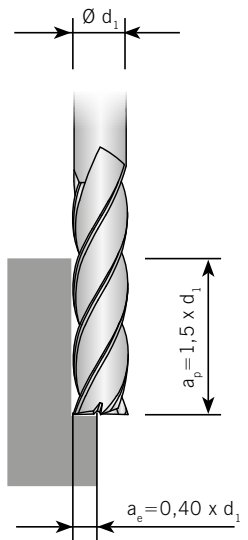

Achtung: Vorschub-Korrekturfaktor  $\rightarrow Kf f_z = 1,10$  bei  $a_p = 1 \times d_1$  und  $\rightarrow Kf f_z = 1,25$  bei  $a_p = 0,5 \times d_1$ . Für unbeschichtete Werkzeuge ist der Vorschub um 10-20% zu reduzieren.

Attention: Feed rate correction factor  $\rightarrow Kf f_z = 1,10$  with  $a_p = 1 \times d_1$  and  $\rightarrow Kf f_z = 1,25$  with  $a_p = 0,5 \times d_1$ . Feed rates are reduced by 10-20% for uncoated tools.

Attention: Facteur de correction d'avance  $\rightarrow Kf f_z = 1,10$  pour  $a_p = 1 \times d_1$  et  $\rightarrow Kf f_z = 1,25$  pour  $a_p = 0,5 \times d_1$ . Pour les outils sans revêtement, l'avance doit être réduite de 10 à 20 %.

**Vorschub pro Zahn bei einer radialen Zustellung 60% vom Schneidendurchmesser ( $\varnothing d_1$ )  $\leq 40$  HRC**

Feed per tooth with radial depth of cut of 60% of the cutter ( $\varnothing d_1$ )

Avance par dent avec un engagement radial de 60% du diamètre de coupe ( $\varnothing d_1$ )

$\varnothing d_1$ [mm]	Korrekturfaktor / Correction factor / Facteur de correction									
	1	0,7	0,8	0,9	1,1	1,2	1,5	1,6	1,8	1,9
1	0,001	0,001	0,001	0,001	0,001	0,001	0,001	0,002	0,002	0,002
2	0,003	0,002	0,002	0,002	0,003	0,003	0,004	0,005	0,005	0,006
3	0,005	0,003	0,004	0,004	0,005	0,006	0,007	0,008	0,009	0,009
4	0,006	0,004	0,005	0,005	0,007	0,007	0,009	0,010	0,011	0,012
5	0,008	0,005	0,006	0,007	0,009	0,010	0,012	0,013	0,015	0,016
6	0,009	0,006	0,007	0,008	0,010	0,011	0,014	0,015	0,017	0,018
8	0,013	0,009	0,010	0,011	0,014	0,015	0,019	0,020	0,023	0,024
10	0,016	0,011	0,013	0,014	0,017	0,019	0,024	0,026	0,029	0,030
12	0,019	0,013	0,015	0,017	0,021	0,023	0,029	0,031	0,035	0,037
14	0,022	0,015	0,018	0,020	0,025	0,027	0,034	0,036	0,040	0,043
16	0,026	0,018	0,020	0,023	0,028	0,031	0,039	0,041	0,046	0,049
18	0,029	0,020	0,023	0,026	0,032	0,035	0,043	0,046	0,052	0,055
20	0,032	0,022	0,026	0,029	0,035	0,039	0,048	0,052	0,058	0,061
22	0,035	0,025	0,030	0,031	0,038	0,041	0,053	0,054	0,064	0,066
25	0,040	0,028	0,032	0,036	0,045	0,049	0,061	0,065	0,073	0,077

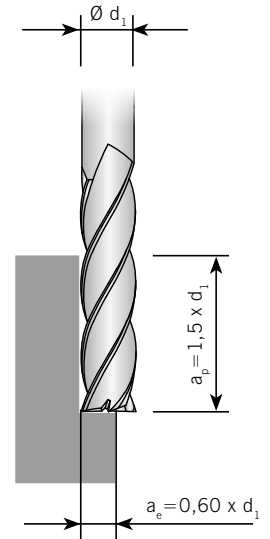

**Vorschub pro Zahn bei einer radialen Zustellung 80% vom Schneidendurchmesser ( $\varnothing d_1$ )  $\leq 40$  HRC**

Feed per tooth with radial depth of cut of 80% of the cutter ( $\varnothing d_1$ )

Avance par dent avec un engagement radial de 80% du diamètre de coupe ( $\varnothing d_1$ )

$\varnothing d_1$ [mm]	Korrekturfaktor / Correction factor / Facteur de correction									
	1	0,7	0,8	0,9	1,1	1,2	1,5	1,6	1,8	1,9
1	0,001	0,001	0,001	0,001	0,001	0,001	0,001	0,001	0,001	0,001
2	0,002	0,001	0,002	0,002	0,002	0,003	0,003	0,004	0,004	0,004
3	0,004	0,002	0,003	0,003	0,004	0,004	0,006	0,006	0,007	0,007
4	0,005	0,003	0,004	0,004	0,005	0,006	0,007	0,008	0,009	0,009
5	0,006	0,004	0,005	0,005	0,007	0,007	0,009	0,010	0,011	0,012
6	0,007	0,005	0,006	0,006	0,008	0,009	0,011	0,012	0,013	0,014
8	0,010	0,007	0,008	0,009	0,011	0,012	0,015	0,016	0,018	0,019
10	0,012	0,008	0,010	0,011	0,013	0,015	0,018	0,020	0,022	0,023
12	0,015	0,010	0,012	0,013	0,016	0,018	0,022	0,024	0,027	0,028
14	0,017	0,012	0,014	0,015	0,019	0,021	0,026	0,028	0,031	0,033
16	0,020	0,014	0,016	0,018	0,022	0,024	0,030	0,032	0,036	0,038
18	0,022	0,015	0,018	0,020	0,024	0,027	0,033	0,036	0,040	0,042
20	0,025	0,017	0,020	0,022	0,027	0,030	0,037	0,040	0,045	0,047
22	0,030	0,020	0,020	0,024	0,030	0,031	0,040	0,045	0,050	0,050
25	0,031	0,022	0,025	0,028	0,034	0,037	0,047	0,050	0,056	0,059

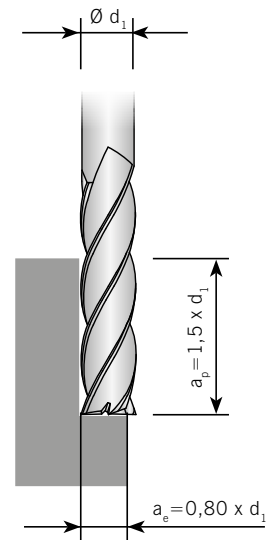

Achtung: Vorschub-Korrekturfaktor  $\rightarrow Kf f_z = 1,10$  bei  $a_p = 1 \times d_1$  und  $\rightarrow Kf f_z = 1,25$  bei  $a_p = 0,5 \times d_1$ . Für unbeschichtete Werkzeuge ist der Vorschub um 10-20% zu reduzieren.

Attention: Feed rate correction factor  $\rightarrow Kf f_z = 1,10$  with  $a_p = 1 \times d_1$  and  $\rightarrow Kf f_z = 1,25$  with  $a_p = 0,5 \times d_1$ . Feed rates are reduced by 10-20% for uncoated tools.

Attention: Facteur de correction d'avance  $\rightarrow Kf f_z = 1,10$  pour  $a_p = 1 \times d_1$  et  $\rightarrow Kf f_z = 1,25$  pour  $a_p = 0,5 \times d_1$ . Pour les outils sans revêtement, l'avance doit être réduite de 10 à 20%.

AFG



**Vorschub pro Zahn beim Vollnutfräsen →  $a_p = 0,5 \times d_1$**

Feed per tooth when full slot milling →  $a_p = 0,5 \times d_1$

Avance par dent pour le rainurage →  $a_p = 0,5 \times d_1$

≤ 40 HRC

Ø d <sub>1</sub> [mm]	Korrekturfaktor / Correction factor / Facteur de correction									
	1	0,7	0,8	0,9	1,1	1,2	1,5	1,6	1,8	1,9
1	0,002	0,001	0,001	0,001	0,002	0,002	0,003	0,003	0,003	0,003
2	0,004	0,002	0,003	0,003	0,004	0,004	0,006	0,006	0,007	0,007
3	0,007	0,004	0,005	0,006	0,007	0,008	0,010	0,011	0,012	0,013
4	0,009	0,006	0,007	0,008	0,009	0,010	0,013	0,014	0,016	0,017
5	0,011	0,007	0,008	0,009	0,012	0,013	0,016	0,017	0,019	0,020
6	0,013	0,009	0,010	0,011	0,014	0,015	0,019	0,020	0,023	0,024
8	0,018	0,012	0,014	0,016	0,019	0,021	0,027	0,028	0,032	0,034
10	0,022	0,015	0,017	0,019	0,024	0,026	0,033	0,035	0,039	0,041
12	0,030	0,021	0,024	0,027	0,033	0,036	0,045	0,048	0,054	0,057
14	0,032	0,022	0,025	0,028	0,035	0,038	0,048	0,051	0,057	0,060
16	0,036	0,025	0,028	0,032	0,039	0,043	0,054	0,057	0,064	0,068
18	0,042	0,029	0,033	0,037	0,046	0,050	0,063	0,067	0,075	0,079
20	0,045	0,031	0,036	0,040	0,049	0,054	0,067	0,072	0,081	0,085
22	0,050	0,035	0,040	0,045	0,055	0,060	0,072	0,076	0,090	0,095
25	0,056	0,039	0,044	0,050	0,061	0,067	0,084	0,089	0,100	0,106

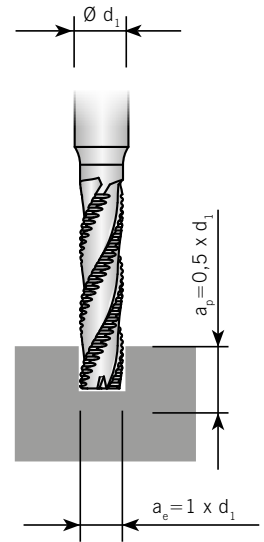

AFG

**Vorschub pro Zahn beim Vollnutfräsen →  $a_p = 1 \times d_1$**

Feed per tooth when full slot milling →  $a_p = 1 \times d_1$

Avance par dent pour le rainurage →  $a_p = 1 \times d_1$

≤ 40 HRC

Ø d <sub>1</sub> [mm]	Korrekturfaktor / Correction factor / Facteur de correction									
	1	0,7	0,8	0,9	1,1	1,2	1,5	1,6	1,8	1,9
1	0,001	0,001	0,001	0,001	0,001	0,002	0,002	0,002	0,002	0,002
2	0,003	0,002	0,002	0,002	0,003	0,003	0,004	0,004	0,005	0,005
3	0,005	0,003	0,004	0,004	0,005	0,005	0,007	0,007	0,008	0,009
4	0,006	0,004	0,005	0,005	0,006	0,007	0,009	0,009	0,011	0,011
5	0,007	0,005	0,006	0,006	0,008	0,009	0,011	0,011	0,013	0,014
6	0,008	0,006	0,007	0,008	0,009	0,010	0,013	0,014	0,015	0,016
8	0,012	0,008	0,009	0,011	0,013	0,014	0,018	0,019	0,021	0,022
10	0,014	0,010	0,011	0,013	0,016	0,017	0,021	0,023	0,026	0,027
12	0,020	0,014	0,016	0,018	0,021	0,023	0,029	0,031	0,035	0,037
14	0,021	0,015	0,017	0,019	0,023	0,025	0,031	0,033	0,037	0,040
16	0,023	0,016	0,019	0,021	0,026	0,028	0,035	0,037	0,042	0,044
18	0,027	0,019	0,022	0,025	0,030	0,033	0,041	0,044	0,049	0,052
20	0,029	0,020	0,023	0,026	0,032	0,035	0,044	0,047	0,053	0,056
22	0,031	0,022	0,025	0,030	0,038	0,040	0,050	0,050	0,060	0,061
25	0,036	0,025	0,029	0,033	0,040	0,044	0,055	0,058	0,066	0,069

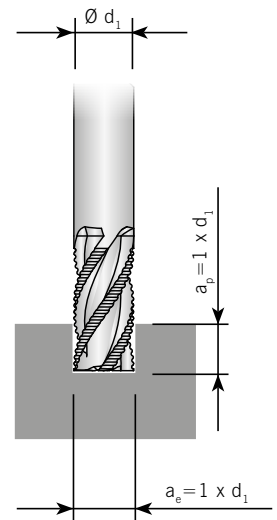

**Achtung:** Vorschub-Korrekturfaktor →  $K_f f_z = 1,10$  bei  $a_p = 1 \times d_1$  und →  $K_f f_z = 1,25$  bei  $a_p = 0,5 \times d_1$ . Für unbeschichtete Werkzeuge ist der Vorschub um 10-20% zu reduzieren.

Attention: Feed rate correction factor →  $K_f f_z = 1,10$  with  $a_p = 1 \times d_1$  and →  $K_f f_z = 1,25$  with  $a_p = 0,5 \times d_1$ . Feed rates are reduced by 10-20% for uncoated tools.

Attention: Facteur de correction d'avance →  $K_f f_z = 1,10$  pour  $a_p = 1 \times d_1$  et →  $K_f f_z = 1,25$  pour  $a_p = 0,5 \times d_1$ . Pour les outils sans revêtement, l'avance doit être réduite de 10 à 20 %.

Vorschübe für Vollradius- und Torusfräser

≤ 40 HRC

Feed rates for ball nosed- and High feed cutters

Avances pour les fraises à rayon complet et toriques

Radiusfräser Ball nose end milling cutters Fraise à rayon		Radiusfräser Ball nose end milling cutters Fraise à rayon		Formenbau-Radiusfräser Ball nose cutter for mold and die production Fraise à rayon pour la fabrication de moules		Torusfräser Torus end milling cutters Fraise torique		Torusfräser Torus end milling cutters Fraise torique	
TiAlN-beschichtet TiAlN-coated Revêtement TiAlN		TiAlN-beschichtet TiAlN-coated Revêtement TiAlN		TiAlN-beschichtet TiAlN-coated Revêtement TiAlN		TiAlN-beschichtet TiAlN-coated Revêtement TiAlN		TiAlN-beschichtet TiAlN-coated Revêtement TiAlN	
d <sub>1</sub> [mm]	fz [mm]	fz [mm]	fz [mm]	fz [mm]	fz [mm]	fz [mm]	fz [mm]	fz [mm]	fz [mm]
2	0,015	0,010	0,005	0,010	0,015	0,010	0,015	0,015	0,020
3	0,030	0,020	0,015	0,015	0,020	0,020	0,030	0,030	0,040
4	0,040	0,030	0,030	0,030	0,040	0,030	0,040	0,040	0,060
5	0,060	0,050	0,050	0,050	0,060	0,050	0,060	0,060	0,080
6	0,070	0,060	0,060	0,060	0,070	0,070	0,080	0,080	0,100
8	0,100	0,080	0,080	0,080	0,100	0,080	0,100	0,100	0,120
10	0,120	0,100	0,090	0,090	0,120	0,100	0,120	0,120	0,130
12	0,150	0,120	0,100	0,100	0,150	0,110	0,130	0,130	0,150
14	0,160	0,140	0,110	0,110	0,160	0,120	0,140	0,140	0,160
16	0,180	0,150	0,120	0,120	0,180	0,140	0,160	0,160	0,180
18	0,200	0,180	0,130	0,130	0,200	0,150	0,170	0,170	0,200
20	0,220	0,200	0,140	0,140	0,220	0,170	0,190	0,190	0,200
25	0,240	0,220	0,140	0,140	0,240	0,170	0,190	0,190	0,200

Achtung: Für unbeschichtete Werkzeuge ist der Vorschub um 10-20% zu reduzieren.

Attention: Feed rates are reduced by 10-20% for uncoated tools.

Attention: Pour les outils sans revêtement, l'avance doit être réduite de 10 à 20 %.

AFG

Vorschub pro Zahn  $f_z$  [mm], gehärtete Stähle, Trockenbearbeitung

≤ 40 HRC

Feed per tooth  $f_z$  [mm], hardened materials, dry processing

Avance par dent  $f_z$  [mm], aciers trempés, usinage à sec

VHM-Schaftfräser Solid carbide end-mill Fraise à queue en carbure monobloc		VHM-Schaftfräser Solid carbide end-mill Fraise à queue en carbure monobloc		VHM-Schaftfräser Solid carbide end-mill Fraise à queue en carbure monobloc		VHM-Schaftfräser Solid carbide end-mill Fraise à queue en carbure monobloc		VHM-Schaftfräser Solid carbide end-mill Fraise à queue en carbure monobloc	
Härte/Hardness = 40-56 HRC Vc = 80-120 m/min		Härte/Hardness = 40-56 HRC Vc = 80-120 m/min		Härte/Hardness = 40-56 HRC Vc = 20-50 m/min		Härte/Hardness = 52-66 HRC Vc = 80-120 m/min		Härte/Hardness = 52-60 HRC Vc = 12-20 m/min	
TiAlN-beschichtet TiAlN-coated Revêtement TiAlN		TiAlN-beschichtet TiAlN-coated Revêtement TiAlN		TiAlN-beschichtet TiAlN-coated Revêtement TiAlN		TiAlN-beschichtet TiAlN-coated Revêtement TiAlN		TiAlN-beschichtet TiAlN-coated Revêtement TiAlN	
$d_1$ [mm]	$f_z$ [mm]	$f_z$ [mm]	$f_z$ [mm]	$f_z$ [mm]	$f_z$ [mm]	$f_z$ [mm]	$f_z$ [mm]	$f_z$ [mm]	$f_z$ [mm]
2	0,005	0,005	0,004	0,005	0,002				
3	0,008	0,008	0,006	0,008	0,003				
4	0,015	0,013	0,009	0,010	0,004				
5	0,020	0,017	0,011	0,013	0,006				
6	0,026	0,021	0,015	0,015	0,008				
8	0,035	0,029	0,020	0,020	0,010				
10	0,043	0,036	0,025	0,025	0,013				
12	0,052	0,043	0,030	0,030	0,015				
14	0,060	0,050	0,035	0,035	0,018				
16	0,060	0,057	0,040	0,040	0,020				
18	0,060	0,060	0,045	0,045	0,023				
20	0,060	0,060	0,050	0,050	0,025				
22	0,060	0,060	0,050	0,050	0,030				
25	0,060	0,065	0,055	0,055	0,035				

Achtung: Für unbeschichtete Werkzeuge ist der Vorschub um 10-20% zu reduzieren.

Attention: Feed rates are reduced by 10-20% for uncoated tools.

Attention: Pour les outils sans revêtement, l'avance doit être réduite de 10 à 20%.

AFG

Vorschub pro Zahn  $f_z$  [mm], gehärtete Stähle, Trockenbearbeitung

≤ 40 HRC

Feed per tooth  $f_z$  [mm], hardened materials, dry processing

Avance par dent  $f_z$  [mm], aciers trempés, usinage à sec

Radiusfräser <i>Ball nose end milling cutters</i> Fraise à rayon		Radiusfräser <i>Ball nose end milling cutters</i> Fraise à rayon		Formenbau-Radiusfräser <i>Ball nose cutter for mold and die production</i> Fraise à rayon pour la fabrication de moules		Formenbau-Radiusfräser <i>Ball nose cutter for mold and die production</i> Fraise à rayon pour la fabrication de moules		Torusfräser <i>Torus end milling cutters</i> Fraise torique		Torusfräser <i>Torus end milling cutters</i> Fraise torique	
Härte / Hardness / Dureté = 40-63 HRC Vc = 80-120 m/min		Härte / Hardness / Dureté = 40-60 HRC Vc = 80-120 m/min		Härte / Hardness / Dureté = 40-56 HRC Vc = 80-120 m/min		Härte / Hardness / Dureté = 40-60 HRC Vc = 80-120 m/min		Härte / Hardness / Dureté = 40-60 HRC Vc = 80-120 m/min		Härte / Hardness / Dureté = 40-60 HRC Vc = 80-120 m/min	
TiAlN-beschichtet TiAlN-coated		TiAlN-beschichtet TiAlN-coated		TiAlN-beschichtet TiAlN-coated		TiAlN-beschichtet TiAlN-coated		TiAlN-beschichtet TiAlN-coated		TiAlN-beschichtet TiAlN-coated	
$d_1$ [mm]	$f_z$ [mm]	$f_z$ [mm]	$f_z$ [mm]	$f_z$ [mm]	$f_z$ [mm]	$f_z$ [mm]	$f_z$ [mm]	$f_z$ [mm]	$f_z$ [mm]	$f_z$ [mm]	$f_z$ [mm]
2	0,005	0,005	0,005	0,005	0,005	0,005	0,005	0,005	0,005	0,005	0,005
3	0,015	0,010	0,010	0,015	0,010	0,015	0,010	0,015	0,010	0,015	0,010
4	0,030	0,015	0,015	0,030	0,015	0,030	0,015	0,030	0,015	0,030	0,015
5	0,050	0,020	0,020	0,050	0,020	0,050	0,020	0,050	0,020	0,050	0,020
6	0,060	0,030	0,030	0,060	0,030	0,060	0,030	0,060	0,030	0,060	0,030
8	0,070	0,035	0,035	0,070	0,035	0,070	0,035	0,070	0,035	0,070	0,035
10	0,080	0,040	0,040	0,080	0,040	0,080	0,040	0,080	0,040	0,080	0,040
12	0,080	0,050	0,050	0,080	0,050	0,080	0,050	0,080	0,050	0,080	0,050
14	0,090	0,065	0,065	0,100	0,065	0,100	0,065	0,090	0,065	0,090	0,065
16	0,100	0,080	0,080	0,100	0,080	0,100	0,080	0,100	0,080	0,100	0,080
18	0,100	0,100	0,100	0,110	0,100	0,110	0,100	0,110	0,100	0,110	0,100
20	0,120	0,120	0,120	0,130	0,120	0,130	0,120	0,120	0,120	0,120	0,120
25	0,120	0,120	0,120	0,130	0,120	0,130	0,120	0,120	0,120	0,120	0,120

Achtung: Für unbeschichtete Werkzeuge ist der Vorschub um 10-20% zu reduzieren.

Attention: Feed rates are reduced by 10-20% for uncoated tools.

Attention: Pour les outils sans revêtement, l'avance doit être réduite de 10 à 20%.

AFG

# ARNO®

## WERKZEUGE

We have a passion for precision.

# AUSFÜHRUNG AFH

*Design AFH / Modèle AFH*

**Nimmt's auch mit den Harten auf.**

*For the really hard jobs.*

*Pour les matières très dures.*

Die ARNO® AFH VHM-Fräser sind für gehärtete Stähle bis 70 HRC sowie für Gussformen im Werkzeugbau und die HSC-Bearbeitung geeignet – auch Trockenbearbeitung ist möglich.



*This series is suitable for milling steel up to 70 HRC as well as high speed milling. Can be run dry.*

Les fraises en carbure monobloc ARNO® AFH sont adaptées à l'usinage des aciers trempés jusqu'à 70 HRC, les moules, les aciers à outils et l'usinage à grande vitesse. L'usinage à sec est également possible.

Solid carbide end-mill

Fraise carbure monobloc à tige

## AFH50120-...R...

2 Schneiden, Mini-Ausführung, mit Eckenradius / 2 flutes, mini design, with corner radius / 2 dents, version mini, avec rayon d'angle

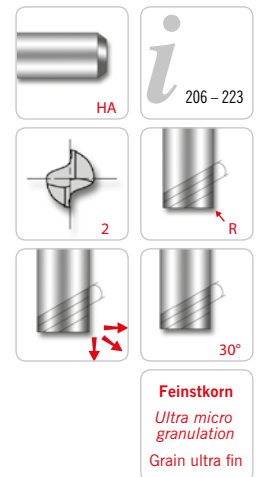
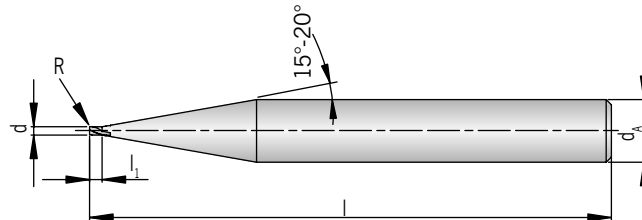

PG 24

beschichtet  
coated  
revêtu

Schaft DIN 6535HA

Shank  
Tige

	d -0,012	d <sub>A</sub> h6	l <sub>1</sub>	l	R ± 0,01	TIA70
AFH50120-003	0,3	6	0,45	50	-	●
AFH50120-004	0,4	6	0,60	50	-	●
AFH50120-005R0,05	0,5	6	0,70	50	0,05	●
AFH50120-006R0,05	0,6	6	0,90	50	0,05	●
AFH50120-008R0,05	0,8	6	1,20	50	0,05	●
AFH50120-010R0,1	1,0	6	1,50	50	0,10	●
AFH50120-012R0,1	1,2	6	1,80	50	0,10	●
AFH50120-015R0,15	1,5	6	2,20	50	0,15	●
AFH50120-020R0,15	2,0	6	2,20	50	0,15	●

P	●
M	
K	
N	
S	
H	●

● Hauptanwendung  
Main application  
Application principale

○ Nebenanwendung  
Secondary application  
Application secondaire

Solid carbide end-mill (Slotting)

Fraise carbure monobloc à tige (fraises à rainer)

## AFH50526-...

2 Schneiden, Mini-Ausführung / 2 flutes, mini design / 2 dents, version mini

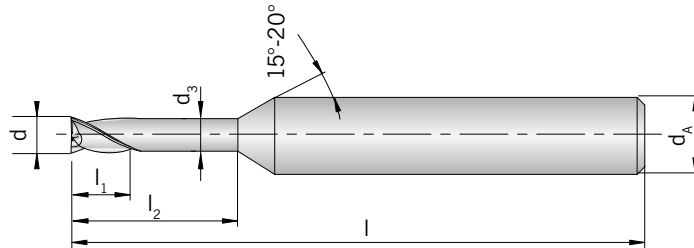

							PG 24
							beschichtet coated revêtu
Schaft DIN 6535HA Shank Tige	d -0,012	d <sub>A</sub> h6	d <sub>3</sub>	l <sub>1</sub>	l <sub>2</sub>	l	TiAlN
AFH50526-001A	0,1	4	0,085	0,15	0,3	45	●
AFH50526-001B	0,1	4	0,085	0,15	0,5	45	●
AFH50526-002A	0,2	4	0,180	0,30	0,5	45	●
AFH50526-002B	0,2	4	0,180	0,30	1,0	45	●
AFH50526-002C	0,2	4	0,180	0,30	1,5	45	●
AFH50526-003A	0,3	4	0,270	0,45	1,0	45	●
AFH50526-003B	0,3	4	0,270	0,45	1,5	45	●
AFH50526-003C	0,3	4	0,270	0,45	2,0	45	●
AFH50526-003D	0,3	4	0,270	0,45	3,0	45	●
AFH50526-003E	0,3	4	0,270	0,45	4,0	45	●
AFH50526-004A	0,4	4	0,370	0,60	1,0	45	●
AFH50526-004B	0,4	4	0,370	0,60	2,0	45	●
AFH50526-004C	0,4	4	0,370	0,60	3,0	45	●
AFH50526-004D	0,4	4	0,370	0,60	4,0	45	●
AFH50526-004E	0,4	4	0,370	0,60	5,0	45	●
AFH50526-005A	0,5	4	0,450	0,70	2,0	45	●
AFH50526-005B	0,5	4	0,450	0,70	2,5	45	●
AFH50526-005C	0,5	4	0,450	0,70	4,0	45	●
AFH50526-005D	0,5	4	0,450	0,70	6,0	45	●
AFH50526-005E	0,5	4	0,450	0,70	8,0	45	●
AFH50526-006A	0,6	4	0,550	0,90	2,0	45	●
AFH50526-006B	0,6	4	0,550	0,90	3,0	45	●
AFH50526-006C	0,6	4	0,550	0,90	4,0	45	●
AFH50526-006D	0,6	4	0,550	0,90	6,0	45	●
AFH50526-006E	0,6	4	0,550	0,90	8,0	45	●
AFH50526-006F	0,6	4	0,550	0,90	10,0	45	●
AFH50526-008A	0,8	4	0,750	1,20	2,0	45	●
AFH50526-008B	0,8	4	0,750	1,20	4,0	45	●
AFH50526-008C	0,8	4	0,750	1,20	6,0	45	●
AFH50526-008D	0,8	4	0,750	1,20	8,0	45	●
AFH50526-008E	0,8	4	0,750	1,20	10,0	45	●
AFH50526-008F	0,8	4	0,750	1,20	12,0	45	●
AFH50526-010A	1,0	4	0,950	1,50	4,0	45	●

Solid carbide end-mill (Slotting)

Fraise carbure monobloc à tige (fraises à rainier)

PG 24

beschichtet  
coated  
revêtu

Schaft DIN 6535HA Shank Tige	d -0,012	d <sub>A</sub> h6	d <sub>3</sub>	l <sub>1</sub>	l <sub>2</sub>	l	TIA70
AFH50526-010B	1,0	4	0,950	1,50	6,0	45	●
AFH50526-010C	1,0	4	0,950	1,50	8,0	45	●
AFH50526-010D	1,0	4	0,950	1,50	10,0	45	●
AFH50526-010E	1,0	4	0,950	1,50	12,0	45	●
AFH50526-010F	1,0	4	0,950	1,50	16,0	50	●
AFH50526-010G	1,0	4	0,950	1,50	20,0	55	●
AFH50526-012A	1,2	4	1,150	1,80	6,0	45	●
AFH50526-012B	1,2	4	1,150	1,80	8,0	45	●
AFH50526-012C	1,2	4	1,150	1,80	10,0	45	●
AFH50526-012D	1,2	4	1,150	1,80	12,0	45	●
AFH50526-012E	1,2	4	1,150	1,80	16,0	50	●
AFH50526-015A	1,5	4	1,450	2,30	6,0	45	●
AFH50526-015B	1,5	4	1,450	2,30	8,0	45	●
AFH50526-015C	1,5	4	1,450	2,30	10,0	45	●
AFH50526-015D	1,5	4	1,450	2,30	12,0	45	●
AFH50526-015E	1,5	4	1,450	2,30	14,0	50	●
AFH50526-015F	1,5	4	1,450	2,30	16,0	50	●
AFH50526-015G	1,5	4	1,450	2,30	18,0	55	●
AFH50526-015H	1,5	4	1,450	2,30	20,0	55	●
AFH50526-020A	2,0	4	1,950	3,00	6,0	45	●
AFH50526-020B	2,0	4	1,950	3,00	8,0	45	●
AFH50526-020C	2,0	4	1,950	3,00	10,0	45	●
AFH50526-020D	2,0	4	1,950	3,00	12,0	45	●
AFH50526-020E	2,0	4	1,950	3,00	14,0	50	●
AFH50526-020F	2,0	4	1,950	3,00	16,0	50	●
AFH50526-020G	2,0	4	1,950	3,00	18,0	55	●
AFH50526-020H	2,0	4	1,950	3,00	20,0	55	●
AFH50526-020J	2,0	4	1,950	3,00	25,0	60	●
AFH50526-020K	2,0	4	1,950	3,00	30,0	70	●
AFH50526-030A	3,0	6	2,850	4,50	10,0	45	●
AFH50526-030B	3,0	6	2,850	4,50	12,0	45	●
AFH50526-030C	3,0	6	2,850	4,50	14,0	50	●
AFH50526-030D	3,0	6	2,850	4,50	16,0	55	●
AFH50526-030E	3,0	6	2,850	4,50	18,0	55	●
AFH50526-030F	3,0	6	2,850	4,50	20,0	60	●
AFH50526-030G	3,0	6	2,850	4,50	25,0	65	●
AFH50526-030H	3,0	6	2,850	4,50	30,0	70	●
AFH50526-030J	3,0	6	2,850	4,50	35,0	80	●
AFH50526-030K	3,0	6	2,850	4,50	40,0	90	●
AFH50526-040A	4,0	6	3,850	6,00	12,0	50	●
AFH50526-040B	4,0	6	3,850	6,00	16,0	60	●
AFH50526-040C	4,0	6	3,850	6,00	20,0	60	●
AFH50526-040D	4,0	6	3,850	6,00	25,0	70	●
AFH50526-040E	4,0	6	3,850	6,00	30,0	70	●
AFH50526-040F	4,0	6	3,850	6,00	35,0	80	●
AFH50526-040G	4,0	6	3,850	6,00	40,0	90	●
AFH50526-040H	4,0	6	3,850	6,00	45,0	90	●
AFH50526-040J	4,0	6	3,850	6,00	50,0	100	●

● **Hauptanwendung**  
Main application  
Application principale

○ **Nebenanwendung**  
Secondary application  
Application secondaire

P	●
M	
K	
N	
S	
H	●

AFH



Solid carbide end-mill (Slotting)

Fraise carbure monobloc à tige (fraises à rainer)

## AFH50920-...R...

2 Schneiden, Mini-Ausführung, mit Eckenradius / 2 flutes, mini design, with corner radius / 2 dents, version mini, avec rayon d'angle

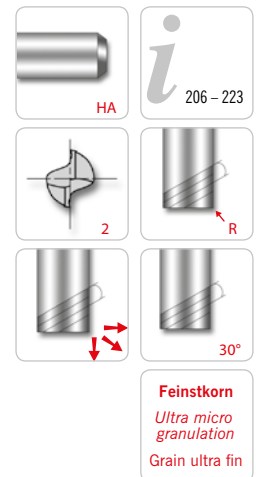
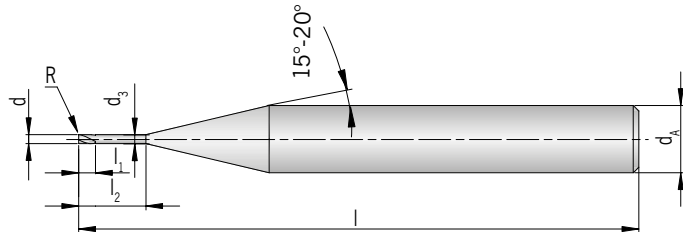

									PG 24
									beschichtet coated revêtu
Schaft DIN 6535HA Shank Tige	d -0,012	d <sub>A</sub> h6	d <sub>3</sub>	l <sub>1</sub>	l <sub>2</sub>	l	R ± 0,01	TIA70	
AFH50920-005AR0,05	0,5	6	0,45	0,7	1,5	50	0,05	●	
AFH50920-005BR0,05	0,5	6	0,45	0,7	3,3	50	0,05	●	
AFH50920-006AR0,05	0,6	6	0,55	0,9	2,0	50	0,05	●	
AFH50920-006BR0,05	0,6	6	0,55	0,9	4,0	50	0,05	●	
AFH50920-008AR0,05	0,8	6	0,75	1,2	2,5	50	0,05	●	
AFH50920-008BR0,05	0,8	6	0,75	1,2	5,5	50	0,05	●	
AFH50920-010AR0,1	1,0	6	0,95	1,5	3,3	50	0,10	●	
AFH50920-010BR0,1	1,0	6	0,95	1,5	6,7	50	0,10	●	
AFH50920-012AR0,1	1,2	6	1,15	1,8	4,4	50	0,10	●	
AFH50920-012BR0,1	1,2	6	1,15	1,8	8,0	50	0,10	●	
AFH50920-015AR0,15	1,5	6	1,45	2,2	5,0	50	0,15	●	
AFH50920-015BR0,15	1,5	6	1,45	2,2	9,7	50	0,15	●	
AFH50920-020AR0,15	2,0	6	1,95	2,2	6,0	50	0,15	●	
AFH50920-020BR0,15	2,0	6	1,95	2,2	13,0	50	0,15	●	

P	●
M	
K	
N	
S	
H	●

● Hauptanwendung  
Main application  
Application principale

○ Nebenanwendung  
Secondary application  
Application secondaire

Solid carbide ball-nose end-mill  
Fraise carbure monobloc hémisphérique

## AFH50320-...

2 Schneiden, Mini-Ausführung / 2 flutes, mini design / 2 dents, version mini

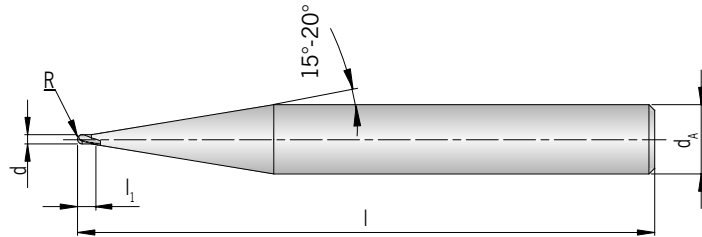

AFH

							PG 24
							beschichtet coated revêtu
Schaft DIN 6535HA Shank Tige	d -0,012	d <sub>A</sub> h6	l <sub>1</sub>	l	R ± 0,01	TiAlN	
AFH50320-004	0,4	6	0,4	50	0,20	●	
AFH50320-005	0,5	6	0,5	50	0,25	●	
AFH50320-006	0,6	6	0,6	50	0,30	●	
AFH50320-008	0,8	6	0,8	50	0,40	●	
AFH50320-010	1,0	6	1,0	50	0,50	●	
AFH50320-012	1,2	6	1,2	50	0,60	●	
AFH50320-015	1,5	6	1,5	50	0,75	●	
AFH50320-020	2,0	6	2,0	50	1,00	●	

P	●
M	
K	
N	
S	
H	●

● **Hauptanwendung**  
Main application  
Application principale

○ **Nebenanwendung**  
Secondary application  
Application secondaire

Solid carbide ball-nose end-mill (Slotting)

Fraise carbure monobloc hémisphérique (fraises à rainer)

## AFH52020-...

2 Schneiden, Mini-Ausführung / 2 flutes, mini design / 2 dents, version mini

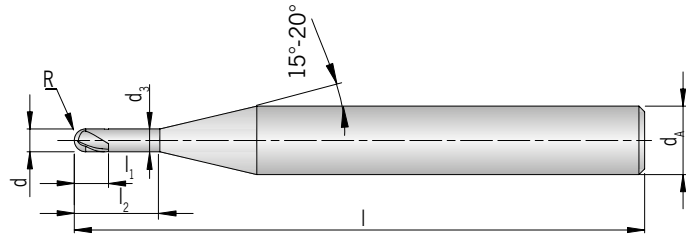

									PG 24
									beschichtet coated revêtu
Schaft DIN 6535HA Shank Tige	d -0,012	d <sub>A</sub> h6	d <sub>3</sub>	l <sub>1</sub>	l <sub>2</sub>	l	R ± 0,005	TiAlN	
AFH52020-005A	0,5	6	0,45	0,5	1,5	50	0,25	●	
AFH52020-005B	0,5	6	0,45	0,5	3,3	50	0,25	●	
AFH52020-006A	0,6	6	0,55	0,6	2,0	50	0,30	●	
AFH52020-006B	0,6	6	0,55	0,6	4,0	50	0,30	●	
AFH52020-008A	0,8	6	0,75	0,8	2,5	50	0,40	●	
AFH52020-008B	0,8	6	0,75	0,8	5,5	50	0,40	●	
AFH52020-010A	1,0	6	0,95	1,0	3,3	50	0,50	●	
AFH52020-010B	1,0	6	0,95	1,0	6,7	50	0,50	●	
AFH52020-010C	1,0	6	0,95	1,0	12,0	50	0,50	●	
AFH52020-012A	1,2	6	1,15	1,2	4,4	50	0,60	●	
AFH52020-012B	1,2	6	1,15	1,2	8,0	50	0,60	●	
AFH52020-015A	1,5	6	1,45	1,5	5,0	50	0,75	●	
AFH52020-015B	1,5	6	1,45	1,5	9,7	50	0,75	●	
AFH52020-015C	1,5	6	1,45	1,5	15,0	50	0,75	●	
AFH52020-020A	2,0	6	1,95	2,0	6,0	50	1,00	●	
AFH52020-020B	2,0	6	1,95	2,0	13,0	50	1,00	●	
AFH52020-020C	2,0	6	1,95	2,0	20,0	60	1,00	●	

P	●
M	
K	
N	
S	
H	●

● Hauptanwendung  
Main application  
Application principale

○ Nebenanwendung  
Secondary application  
Application secondaire

Solid carbide ball-nose end-mill (Slotting)

Fraise carbure monobloc hémisphérique (fraises à rainer)

## AFH52021-...

2 Schneiden, Mini-Ausführung / 2 flutes, mini design / 2 dents, version mini

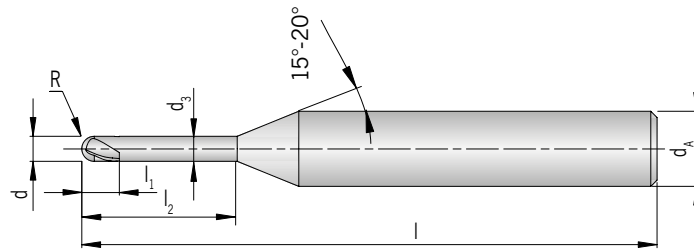

PG 24

beschichtet  
coated  
revêtu

Schaft DIN 6535HA

Shank  
Tige

	d -0,012	d <sub>A</sub> h6	d <sub>3</sub>	l <sub>1</sub>	l <sub>2</sub>	l	R ± 0,005	TIA70
AFH52021-001A	0,1	4	0,085	0,1	0,3	45	0,05	●
AFH52021-001B	0,1	4	0,085	0,1	0,5	45	0,05	●
AFH52021-002A	0,2	4	0,180	0,2	0,5	45	0,10	●
AFH52021-002B	0,2	4	0,180	0,2	1,0	45	0,10	●
AFH52021-002C	0,2	4	0,180	0,2	1,5	45	0,10	●
AFH52021-003A	0,3	4	0,270	0,3	1,0	45	0,15	●
AFH52021-003B	0,3	4	0,270	0,3	2,0	45	0,15	●
AFH52021-003C	0,3	4	0,270	0,3	3,0	45	0,15	●
AFH52021-004A	0,4	4	0,370	0,4	1,0	45	0,20	●
AFH52021-004B	0,4	4	0,370	0,4	2,0	45	0,20	●
AFH52021-004C	0,4	4	0,370	0,4	3,0	45	0,20	●
AFH52021-004D	0,4	4	0,370	0,4	4,0	45	0,20	●
AFH52021-004E	0,4	4	0,370	0,4	5,0	45	0,20	●
AFH52021-005A	0,5	4	0,450	0,4	2,0	45	0,25	●
AFH52021-005B	0,5	4	0,450	0,4	2,5	45	0,25	●
AFH52021-005C	0,5	4	0,450	0,4	4,0	45	0,25	●
AFH52021-005D	0,5	4	0,450	0,4	6,0	45	0,25	●
AFH52021-005E	0,5	4	0,450	0,4	8,0	45	0,25	●
AFH52021-006A	0,6	4	0,550	0,5	2,0	45	0,30	●
AFH52021-006B	0,6	4	0,550	0,5	3,0	45	0,30	●
AFH52021-006C	0,6	4	0,550	0,5	4,0	45	0,30	●
AFH52021-006D	0,6	4	0,550	0,5	5,0	45	0,30	●
AFH52021-006E	0,6	4	0,550	0,5	6,0	45	0,30	●
AFH52021-006F	0,6	4	0,550	0,5	8,0	45	0,30	●
AFH52021-006G	0,6	4	0,550	0,5	10,0	45	0,30	●
AFH52021-008A	0,8	4	0,750	0,6	2,0	45	0,40	●
AFH52021-008B	0,8	4	0,750	0,6	4,0	45	0,40	●
AFH52021-008C	0,8	4	0,750	0,6	6,0	45	0,40	●
AFH52021-008D	0,8	4	0,750	0,6	8,0	45	0,40	●
AFH52021-008E	0,8	4	0,750	0,6	10,0	45	0,40	●
AFH52021-010A	1,0	4	0,950	0,8	3,0	45	0,50	●
AFH52021-010B	1,0	4	0,950	0,8	4,0	45	0,50	●
AFH52021-010C	1,0	4	0,950	0,8	5,0	45	0,50	●
AFH52021-010D	1,0	4	0,950	0,8	6,0	45	0,50	●

Solid carbide ball-nose end-mill (Slotting)

Fraise carbure monobloc hémisphérique (fraises à rainer)

								PG 24
								beschichtet coated revêtu
Schaft DIN 6535HA Shank Tige	d -0,012	d <sub>A</sub> h6	d <sub>3</sub>	l <sub>1</sub>	l <sub>2</sub>	l	R ± 0,005	TIA70
AFH52021-010E	1,0	4	0,950	0,8	7,0	45	0,50	●
AFH52021-010F	1,0	4	0,950	0,8	8,0	45	0,50	●
AFH52021-010G	1,0	4	0,950	0,8	9,0	45	0,50	●
AFH52021-010H	1,0	4	0,950	0,8	10,0	45	0,50	●
AFH52021-010J	1,0	4	0,950	0,8	12,0	45	0,50	●
AFH52021-010K	1,0	4	0,950	0,8	14,0	50	0,50	●
AFH52021-010L	1,0	4	0,950	0,8	16,0	50	0,50	●
AFH52021-010M	1,0	4	0,950	0,8	20,0	55	0,50	●
AFH52021-012A	1,2	4	1,150	1,0	6,0	45	0,60	●
AFH52021-012B	1,2	4	1,150	1,0	8,0	45	0,60	●
AFH52021-012C	1,2	4	1,150	1,0	10,0	45	0,60	●
AFH52021-012D	1,2	4	1,150	1,0	12,0	45	0,60	●
AFH52021-015A	1,5	4	1,450	1,2	6,0	45	0,75	●
AFH52021-015B	1,5	4	1,450	1,2	8,0	45	0,75	●
AFH52021-015C	1,5	4	1,450	1,2	10,0	45	0,75	●
AFH52021-015D	1,5	4	1,450	1,2	12,0	45	0,75	●
AFH52021-015E	1,5	4	1,450	1,2	14,0	50	0,75	●
AFH52021-015F	1,5	4	1,450	1,2	16,0	50	0,75	●
AFH52021-015G	1,5	4	1,450	1,2	20,0	55	0,75	●
AFH52021-020A	2,0	4	1,950	1,6	4,0	45	1,00	●
AFH52021-020B	2,0	4	1,950	1,6	6,0	45	1,00	●
AFH52021-020C	2,0	4	1,950	1,6	8,0	45	1,00	●
AFH52021-020D	2,0	4	1,950	1,6	10,0	45	1,00	●
AFH52021-020E	2,0	4	1,950	1,6	12,0	50	1,00	●
AFH52021-020F	2,0	4	1,950	1,6	14,0	50	1,00	●
AFH52021-020G	2,0	4	1,950	1,6	16,0	50	1,00	●
AFH52021-020H	2,0	4	1,950	1,6	18,0	55	1,00	●
AFH52021-020J	2,0	4	1,950	1,6	20,0	55	1,00	●
AFH52021-020K	2,0	4	1,950	1,6	22,0	60	1,00	●
AFH52021-020L	2,0	4	1,950	1,6	25,0	60	1,00	●
AFH52021-020M	2,0	4	1,950	1,6	30,0	70	1,00	●
AFH52021-030A	3,0	6	2,850	2,4	12,0	50	1,50	●
AFH52021-030B	3,0	6	2,850	2,4	14,0	55	1,50	●
AFH52021-030C	3,0	6	2,850	2,4	16,0	55	1,50	●
AFH52021-030D	3,0	6	2,850	2,4	18,0	60	1,50	●
AFH52021-030E	3,0	6	2,850	2,4	20,0	60	1,50	●
AFH52021-030F	3,0	6	2,850	2,4	25,0	65	1,50	●
AFH52021-030G	3,0	6	2,850	2,4	30,0	70	1,50	●
AFH52021-030H	3,0	6	2,850	2,4	35,0	80	1,50	●
AFH52021-040A	4,0	6	3,850	3,2	12,0	60	2,00	●
AFH52021-040B	4,0	6	3,850	3,2	16,0	60	2,00	●
AFH52021-040C	4,0	6	3,850	3,2	20,0	65	2,00	●
AFH52021-040D	4,0	6	3,850	3,2	25,0	70	2,00	●
AFH52021-040E	4,0	6	3,850	3,2	30,0	70	2,00	●
AFH52021-040F	4,0	6	3,850	3,2	35,0	80	2,00	●
AFH52021-040G	4,0	6	3,850	3,2	40,0	90	2,00	●
AFH52021-040H	4,0	6	3,850	3,2	45,0	90	2,00	●
AFH52021-040J	4,0	6	3,850	3,2	50,0	100	2,00	●

AFH

●	P	●
○	M	
○	K	
○	N	
○	S	
○	H	●

● **Hauptanwendung**  
Main application  
Application principale

○ **Nebenanwendung**  
Secondary application  
Application secondaire

Solid carbide end-mill  
Fraise carbure monobloc à tige

## AFH50125-...

2 Schneiden / 2 flutes / 2 dents

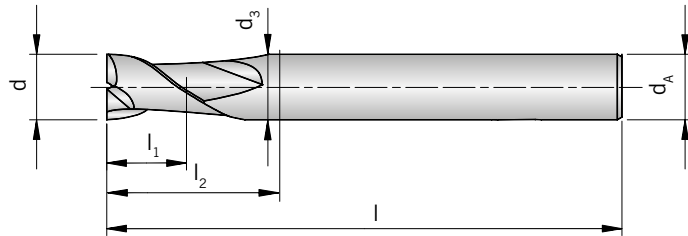

AFH

PG 24

beschichtet  
coated  
revêtu

Schaft DIN 6535HA

Shank  
Tige

	d -0,012	d <sub>A</sub> h6	d <sub>3</sub>	l <sub>1</sub>	l <sub>2</sub>	l	TiAlN
AFH50125-001	0,1	4	-	0,2	-	40	●
AFH50125-002	0,2	4	-	0,4	-	40	●
AFH50125-003	0,3	4	-	0,6	-	40	●
AFH50125-004	0,4	4	-	0,8	-	40	●
AFH50125-005	0,5	4	-	1,0	-	40	●
AFH50125-006	0,6	4	-	1,2	-	40	●
AFH50125-007	0,7	4	-	1,4	-	40	●
AFH50125-008	0,8	4	-	1,6	-	40	●
AFH50125-009	0,9	4	-	2,0	-	40	●
AFH50125-010	1,0	6	0,95	1,5	3	50	●
AFH50125-015	1,5	6	1,45	1,7	4	50	●
AFH50125-020	2,0	6	1,95	2,0	5	50	●
AFH50125-025	2,5	6	2,40	2,5	6	55	●
AFH50125-030	3,0	6	2,85	3,0	8	55	●
AFH50125-035	3,5	6	3,35	3,5	9	55	●
AFH50125-040	4,0	6	3,85	4,0	10	55	●
AFH50125-050	5,0	6	4,85	5,0	13	55	●

P	●
M	
K	
N	
S	
H	●

● Hauptanwendung  
Main application  
Application principale

○ Nebenanwendung  
Secondary application  
Application secondaire

							PG 24
							beschichtet coated revêtu
Schaft DIN 6535HA Shank Tige	d -0,016	d <sub>A</sub> h6	d <sub>3</sub>	l <sub>1</sub>	l <sub>2</sub>	l	TiAl70
AFH50125-060	6	6	5,85	6	15	55	●
AFH50125-080	8	8	7,70	8	20	65	●
AFH50125-100	10	10	9,70	10	25	75	●
AFH50125-120	12	12	11,70	12	28	85	●
AFH50125-160	16	16	15,70	16	32	90	●
AFH50125-200	20	20	19,70	20	40	105	●

P	●
M	
K	
N	
S	
H	●

- **Hauptanwendung**  
Main application  
Application principale
- **Nebenanwendung**  
Secondary application  
Application secondaire

Solid carbide end-mill

Fraise carbure monobloc à tige

## AFH50725-...R...

2 Schneiden, mit Eckenradius / 2 flutes, with corner radius / 2 dents, avec rayon d'angle

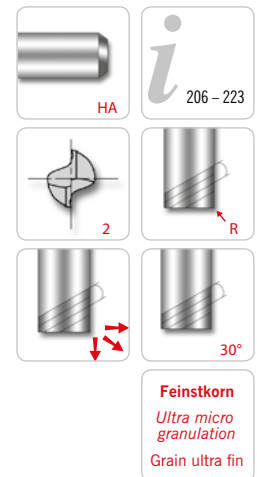
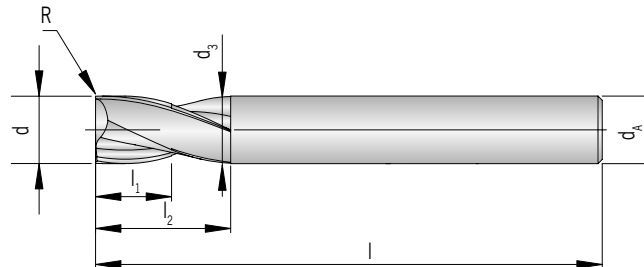

PG 24

beschichtet  
coated  
revêtu

Schaft DIN 6535HA

Shank  
Tige

	d -0,012	d <sub>A</sub> h6	d <sub>3</sub>	l <sub>1</sub>	l <sub>2</sub>	l	R -0,01	TIA70
AFH50725-005R0,05	0,5	4	-	1,0	-	40	0,05	●
AFH50725-006R0,05	0,6	4	-	1,2	-	40	0,05	●
AFH50725-007R0,05	0,7	4	-	1,4	-	40	0,05	●
AFH50725-008R0,05	0,8	4	-	1,6	-	40	0,05	●
AFH50725-009R0,05	0,9	4	-	2,0	-	40	0,05	●
AFH50725-010AR0,1	1,0	4	-	1,5	-	40	0,10	●
AFH50725-010BR0,1	1,0	6	-	1,5	-	40	0,10	●
AFH50725-015R0,1	1,5	6	-	2,2	-	40	0,10	●
AFH50725-020AR0,1	2,0	4	1,95	3,0	6	40	0,10	●
AFH50725-020BR0,1	2,0	6	1,95	3,0	6	40	0,10	●
AFH50725-025R0,1	2,5	6	2,40	4,0	6	40	0,10	●
AFH50725-030R0,1	3,0	6	2,85	4,0	7	45	0,10	●
AFH50725-035R0,1	3,5	6	3,35	5,0	9	45	0,10	●
AFH50725-040R0,1	4,0	6	3,85	5,0	9	45	0,10	●
AFH50725-045R0,1	4,5	6	4,35	6,0	10	45	0,10	●
AFH50725-050R0,2	5,0	6	4,85	6,0	11	50	0,20	●

P	●
M	
K	
N	
S	
H	●

● Hauptanwendung  
Main application  
Application principale

○ Nebenanwendung  
Secondary application  
Application secondaire



								PG 24
								beschichtet coated revêtu
Schaft DIN 6535HA Shank Tige	d -0,015	d <sub>A</sub> h6	d <sub>3</sub>	l <sub>1</sub>	l <sub>2</sub>	l	R -0,015	TiAl70
AFH50725-060R0,2	6	6	5,85	7	14	50	0,2	●
AFH50725-080R0,2	8	8	7,70	9	18	60	0,2	●
AFH50725-100R0,2	10	10	9,70	12	25	75	0,2	●
AFH50725-120R0,3	12	12	11,70	15	30	75	0,3	●
AFH50725-160R0,3	16	16	15,70	18	38	90	0,3	●
AFH50725-200R0,3	20	20	19,70	24	45	100	0,3	●

P	●
M	
K	
N	
S	
H	●

- **Hauptanwendung**  
Main application  
Application principale
- **Nebenanwendung**  
Secondary application  
Application secondaire

Solid carbide end-mill

Fraise carbure monobloc à tige

## AFH50926-...R...

2 Schneiden, mit Eckenradius / 2 flutes, with corner radius / 2 dents, avec rayon d'angle

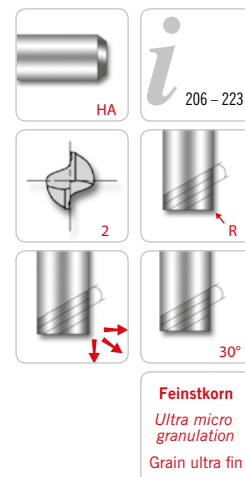
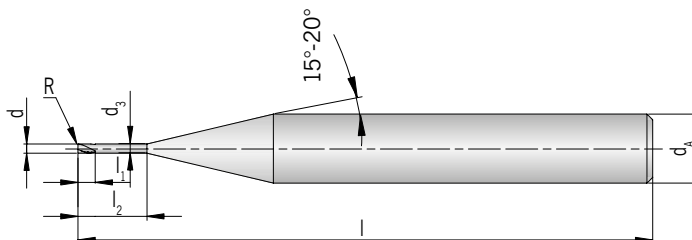

PG 24

beschichtet  
coated  
revêtu

Schaft DIN 6535HA Shank Tige	d -0,012	d <sub>A</sub> h6	d <sub>3</sub>	l <sub>1</sub>	l <sub>2</sub>	l	R -0,01	TIA70
AFH50926-005AR0,05	0,5	4	0,45	0,7	1,5	45	0,05	●
AFH50926-005BR0,05	0,5	4	0,45	0,7	2,5	45	0,05	●
AFH50926-005CR0,05	0,5	4	0,45	0,7	4,0	45	0,05	●
AFH50926-006AR0,05	0,6	4	0,55	0,9	2,0	45	0,05	●
AFH50926-006BR0,05	0,6	4	0,55	0,9	3,0	45	0,05	●
AFH50926-006CR0,05	0,6	4	0,55	0,9	4,0	45	0,05	●
AFH50926-006DR0,1	0,6	4	0,55	0,9	2,0	45	0,10	●
AFH50926-007R0,1	0,7	4	0,65	1,0	4,0	45	0,10	●
AFH50926-008AR0,1	0,8	4	0,75	1,2	2,0	45	0,10	●
AFH50926-008BR0,1	0,8	4	0,75	1,2	4,0	45	0,10	●
AFH50926-008CR0,1	0,8	4	0,75	1,2	6,0	45	0,10	●
AFH50926-010AR0,1	1,0	6	0,95	1,5	4,0	50	0,10	●
AFH50926-010BR0,1	1,0	6	0,95	1,5	6,0	50	0,10	●
AFH50926-010CR0,2	1,0	6	0,95	1,5	4,0	50	0,20	●
AFH50926-010DR0,2	1,0	6	0,95	1,5	6,0	50	0,20	●
AFH50926-010ER0,2	1,0	6	0,95	1,5	8,0	50	0,20	●
AFH50926-010FR0,3	1,0	6	0,95	1,5	4,0	50	0,30	●
AFH50926-010GR0,3	1,0	6	0,95	1,5	6,0	50	0,30	●
AFH50926-010HR0,3	1,0	6	0,95	1,5	8,0	50	0,30	●
AFH50926-015AR0,2	1,5	6	1,45	2,5	4,0	50	0,20	●
AFH50926-015BR0,2	1,5	6	1,45	2,5	6,0	50	0,20	●
AFH50926-015CR0,2	1,5	6	1,45	2,5	8,0	50	0,20	●
AFH50926-015DR0,2	1,5	6	1,45	2,5	10,0	50	0,20	●
AFH50926-015ER0,2	1,5	6	1,45	2,5	12,0	50	0,20	●
AFH50926-015FR0,3	1,5	6	1,45	2,5	4,0	50	0,30	●
AFH50926-015GR0,3	1,5	6	1,45	2,5	6,0	50	0,30	●
AFH50926-015HR0,3	1,5	6	1,45	2,5	8,0	50	0,30	●
AFH50926-020AR0,2	2,0	6	1,95	3,0	6,0	50	0,20	●
AFH50926-020BR0,2	2,0	6	1,95	3,0	8,0	50	0,20	●
AFH50926-020CR0,2	2,0	6	1,95	3,0	10,0	55	0,20	●
AFH50926-020DR0,2	2,0	6	1,95	3,0	12,0	55	0,20	●
AFH50926-020ER0,3	2,0	6	1,95	3,0	6,0	50	0,30	●

PG 24								
beschichtet coated revêtu								
Schaft DIN 6535HA Shank Tige	d -0,012	d <sub>A</sub> h6	d <sub>3</sub>	l <sub>1</sub>	l <sub>2</sub>	l	R -0,01	TIA70
AFH50926-020FR0,3	2,0	6	1,95	3,0	8,0	50	0,30	●
AFH50926-020GR0,3	2,0	6	1,95	3,0	10,0	55	0,30	●
AFH50926-020HR0,3	2,0	6	1,95	3,0	12,0	55	0,30	●
AFH50926-020JR0,3	2,0	6	1,95	3,0	16,0	55	0,30	●
AFH50926-020KR0,5	2,0	6	1,95	3,0	6,0	50	0,50	●
AFH50926-020LR0,5	2,0	6	1,95	3,0	10,0	55	0,50	●
AFH50926-020MR0,5	2,0	6	1,95	3,0	12,0	55	0,50	●
AFH50926-030AR0,2	3,0	6	2,85	4,0	8,0	55	0,20	●
AFH50926-030BR0,2	3,0	6	2,85	4,0	10,0	55	0,20	●
AFH50926-030CR0,2	3,0	6	2,85	4,0	12,0	55	0,20	●
AFH50926-030DR0,2	3,0	6	2,85	4,0	16,0	55	0,20	●
AFH50926-030ER0,3	3,0	6	2,85	4,0	8,0	55	0,30	●
AFH50926-030FR0,3	3,0	6	2,85	4,0	10,0	55	0,30	●
AFH50926-030GR0,3	3,0	6	2,85	4,0	12,0	55	0,30	●
AFH50926-030HR0,3	3,0	6	2,85	4,0	16,0	55	0,30	●
AFH50926-030JR0,5	3,0	6	2,85	4,0	10,0	55	0,50	●
AFH50926-030KR0,5	3,0	6	2,85	4,0	12,0	55	0,50	●
AFH50926-030LR0,5	3,0	6	2,85	4,0	16,0	55	0,50	●
AFH50926-030MR0,5	3,0	6	2,85	4,0	20,0	55	0,50	●
AFH50926-040AR0,2	4,0	6	3,85	5,0	12,0	55	0,20	●
AFH50926-040BR0,2	4,0	6	3,85	5,0	16,0	55	0,20	●
AFH50926-040CR0,2	4,0	6	3,85	5,0	20,0	55	0,20	●
AFH50926-040DR0,3	4,0	6	3,85	5,0	10,0	55	0,30	●
AFH50926-040ER0,3	4,0	6	3,85	5,0	12,0	55	0,30	●
AFH50926-040FR0,3	4,0	6	3,85	5,0	16,0	55	0,30	●
AFH50926-040GR0,3	4,0	6	3,85	5,0	20,0	55	0,30	●
AFH50926-040HR0,5	4,0	6	3,85	5,0	12,0	55	0,50	●
AFH50926-040JR0,5	4,0	6	3,85	5,0	16,0	55	0,50	●
AFH50926-040KR0,5	4,0	6	3,85	5,0	20,0	55	0,50	●
AFH50926-040LR1,0	4,0	6	3,85	5,0	12,0	55	1,00	●
AFH50926-040MR1,0	4,0	6	3,85	5,0	16,0	55	1,00	●

P	●
M	
K	
N	
S	
H	●

- Hauptanwendung  
Main application  
Application principale
- Nebenanwendung  
Secondary application  
Application secondaire

PG 24								
beschichtet coated revêtu								
Schaft DIN 6535HA Shank Tige	d -0,015	d <sub>A</sub> h6	d <sub>3</sub>	l <sub>1</sub>	l <sub>2</sub>	l	R -0,015	TIA70
AFH50926-060AR0,3	6	6	5,85	7	20	60	0,3	●
AFH50926-060BR0,5	6	6	5,85	7	20	60	0,5	●
AFH50926-060CR1,0	6	6	5,85	7	20	60	1,0	●
AFH50926-060DR1,5	6	6	5,85	7	20	60	1,5	●

PG 24

beschichtet  
coated  
revêtu

Schaft DIN 6535HA Shank Tige	d -0,015	d <sub>A</sub> h6	d <sub>3</sub>	l <sub>1</sub>	l <sub>2</sub>	l	R -0,015	TiAl70
AFH50926-060ER2,0	6	6	5,85	7	20	60	2,0	●
AFH50926-080AR0,3	8	8	7,70	9	25	60	0,3	●
AFH50926-080BR0,5	8	8	7,70	9	25	60	0,5	●
AFH50926-080CR1,0	8	8	7,70	9	25	60	1,0	●
AFH50926-080DR1,5	8	8	7,70	9	25	60	1,5	●
AFH50926-080ER2,0	8	8	7,70	9	25	60	2,0	●
AFH50926-100AR0,3	10	10	9,70	11	32	70	0,3	●
AFH50926-100BR0,5	10	10	9,70	11	32	70	0,5	●
AFH50926-100CR1,0	10	10	9,70	11	32	70	1,0	●
AFH50926-100DR1,5	10	10	9,70	11	32	70	1,5	●
AFH50926-100ER2,0	10	10	9,70	11	32	70	2,0	●
AFH50926-120AR0,5	12	12	11,70	12	38	80	0,5	●
AFH50926-120BR1,0	12	12	11,70	12	38	80	1,0	●
AFH50926-120CR1,5	12	12	11,70	12	38	80	1,5	●
AFH50926-120DR2,0	12	12	11,70	12	38	80	2,0	●

P	●
M	
K	
N	
S	
H	●

- **Hauptanwendung**  
Main application  
Application principale
- **Nebenanwendung**  
Secondary application  
Application secondaire

AFH

Solid carbide ball-nose end-mill  
Fraise carbure monobloc hémisphérique

## AFH51625-...

2 Schneiden / 2 flutes / 2 dents

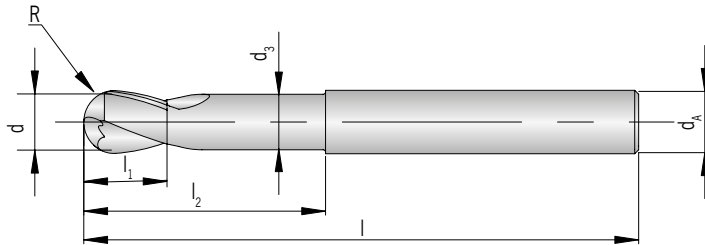

									PG 24
									beschichtet coated revêtu
Schaft DIN 6535HA Shank Tige	d	d <sub>A</sub> h6	d <sub>3</sub>	l <sub>1</sub>	l <sub>2</sub>	l	R -0,005	TIA70	
AFH51625-010	1,0	4	0,95	1,0	2,2	50	0,50	●	
AFH51625-012	1,2	4	1,15	1,2	2,6	50	0,60	●	
AFH51625-015	1,5	4	1,45	1,5	3,0	50	0,75	●	
AFH51625-020	2,0	6	1,95	2,0	4,0	50	1,00	●	
AFH51625-030	3,0	6	2,85	3,0	6,0	60	1,50	●	
AFH51625-040	4,0	6	3,85	4,0	8,0	70	2,00	●	
AFH51625-050	5,0	6	4,85	5,0	10,0	80	2,50	●	

P	●
M	
K	
N	
S	
H	●

● Hauptanwendung  
Main application  
Application principale

○ Nebenanwendung  
Secondary application  
Application secondaire

									PG 24
									beschichtet coated revêtu
Schaft DIN 6535HA Shank Tige	d	d <sub>A</sub> h6	d <sub>3</sub>	l <sub>1</sub>	l <sub>2</sub>	l	R -0,01	TIA70	
AFH51625-060	6	6	5,85	6	12	90	3,0	●	
AFH51625-070	7	8	6,70	7	14	90	3,5	●	
AFH51625-080	8	8	7,70	8	16	100	4,0	●	
AFH51625-090	9	10	8,70	9	18	100	4,5	●	
AFH51625-100	10	10	9,70	10	20	100	5,0	●	

Solid carbide ball-nose end-mill

Fraise carbure monobloc hémisphérique

								PG 24
								beschichtet coated revêtu
Schaft DIN 6535HA Shank Tige	d	d <sub>A</sub> h6	d <sub>3</sub>	l <sub>1</sub>	l <sub>2</sub>	l	R -0,01	TiAl70
AFH51625-120	12	12	11,70	12	24	110	6,0	●
AFH51625-140	14	14	13,70	14	28	110	7,0	●
AFH51625-160	16	16	15,70	16	32	140	8,0	●
AFH51625-180	18	18	17,70	18	36	140	9,0	●
AFH51625-200	20	20	19,70	20	40	160	10,0	●
AFH51625-250	25	25	24,70	25	50	180	12,5	●

P	●
M	
K	
N	
S	
H	●

- **Hauptanwendung**  
Main application  
Application principale
- **Nebenanwendung**  
Secondary application  
Application secondaire

Solid carbide ball-nose end-mill  
Fraise carbure monobloc hémisphérique

## AFH51626-...

2 Schneiden / 2 flutes / 2 dents

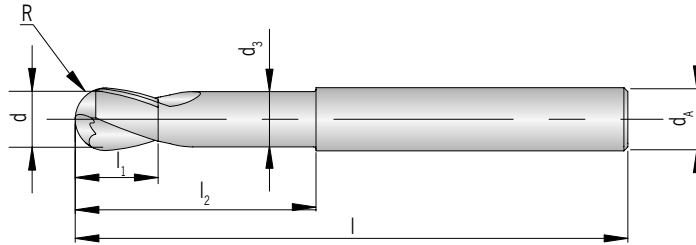

									PG 24
									beschichtet coated revêtu
Schaft DIN 6535HA Shank Tige	d	d <sub>A</sub> h6	d <sub>3</sub>	l <sub>1</sub>	l <sub>2</sub>	l	R -0,005	TiAlN	
AFH51626-001	0,1	4	-	0,2	-	40	0,05	●	
AFH51626-002	0,2	4	-	0,3	-	40	0,10	●	
AFH51626-003	0,3	4	-	0,5	-	40	0,15	●	
AFH51626-004	0,4	4	-	0,6	-	40	0,20	●	
AFH51626-005	0,5	4	-	0,7	-	40	0,25	●	
AFH51626-006	0,6	4	-	0,9	-	40	0,30	●	
AFH51626-007	0,7	4	-	1,1	-	40	0,35	●	
AFH51626-008	0,8	4	-	1,2	-	40	0,40	●	
AFH51626-009	0,9	4	-	1,4	-	40	0,45	●	
AFH51626-010	1,0	6	0,95	1,5	3	50	0,50	●	
AFH51626-015	1,5	6	1,45	2,0	4	50	0,75	●	
AFH51626-020	2,0	6	1,95	2,5	5	50	1,00	●	
AFH51626-025	2,5	6	2,40	3,0	7	50	1,25	●	
AFH51626-030	3,0	6	2,85	4,0	10	60	1,50	●	
AFH51626-035	3,5	6	3,35	4,5	10	60	1,75	●	
AFH51626-040	4,0	6	3,85	5,0	10	60	2,00	●	
AFH51626-045	4,5	6	4,35	5,5	10	60	2,25	●	
AFH51626-050	5,0	6	4,85	6,0	12	60	2,50	●	
AFH51626-055	5,5	6	5,35	6,5	12	60	2,75	●	

P	●
M	
K	
N	
S	
H	●

● Hauptanwendung  
Main application  
Application principale  
○ Nebenanwendung  
Secondary application  
Application secondaire

AFH

Solid carbide ball-nose end-mill  
Fraise carbure monobloc hémisphérique

								PG 24
								beschichtet coated revêtu
Schaft DIN 6535HA Shank Tige	d	d <sub>A</sub> h6	d <sub>3</sub>	l <sub>1</sub>	l <sub>2</sub>	l	R -0,01	TIA70
AFH51626-060A	6	6	5,85	7	15	60	3	●
AFH51626-060B	6	6	5,85	9	30	90	3	●
AFH51626-080A	8	8	7,70	9	15	60	4	●
AFH51626-080B	8	8	7,70	9	15	80	4	●
AFH51626-080C	8	8	7,70	12	30	100	4	●
AFH51626-100A	10	10	9,70	11	25	60	5	●
AFH51626-100B	10	10	9,70	11	25	80	5	●
AFH51626-100C	10	10	9,70	15	30	100	5	●
AFH51626-120	12	12	11,70	14	25	80	6	●

P	●
M	
K	
N	
S	
H	●

● **Hauptanwendung**  
Main application  
Application principale

○ **Nebenanwendung**  
Secondary application  
Application secondaire



Solid carbide ball-nose end-mill  
Fraise carbure monobloc hémisphérique

## AFH51635-...

3 Schneiden / 3 flutes / 3 dents

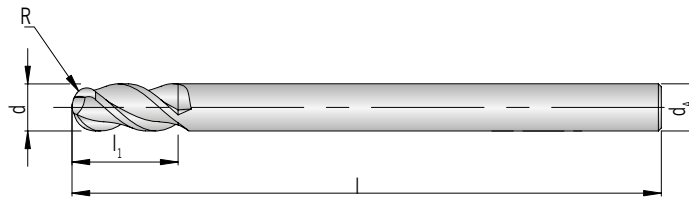

							PG 24
							beschichtet coated revêtu
Schaft DIN 6535HA Shank Tige	d	d <sub>A</sub> h6	l <sub>1</sub>	l	R ±0,005	TiAl70	
AFH51635-030	3	6	8	60	1,5	●	
AFH51635-040	4	6	8	70	2,0	●	
AFH51635-050	5	6	10	80	2,5	●	

● Hauptanwendung Main application Application principale	P	●
	M	
	K	
	N	
○ Nebenanwendung Secondary application Application secondaire	S	
	H	●

							PG 24
							beschichtet coated revêtu
Schaft DIN 6535HA Shank Tige	d	d <sub>A</sub> h6	l <sub>1</sub>	l	R ±0,01	TiAl70	
AFH51635-060	6	6	12	90	3	●	
AFH51635-080	8	8	14	100	4	●	
AFH51635-100	10	10	18	100	5	●	
AFH51635-120	12	12	22	110	6	●	
AFH51635-160	16	16	30	140	8	●	
AFH51635-200	20	20	38	160	10	●	

● Hauptanwendung Main application Application principale	P	●
	M	
	K	
	N	
○ Nebenanwendung Secondary application Application secondaire	S	
	H	●

Solid carbide end-mill

Fraise carbure monobloc à tige

## AFH50140-...

4 Schneiden / 4 flutes / 4 dents

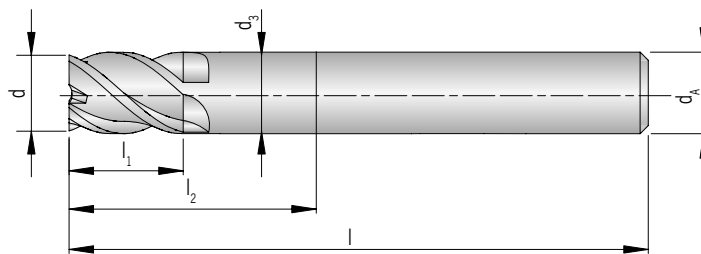

AFH

							PG 24
							beschichtet coated revêtu
Schaft DIN 6535HA Shank Tige	d -0,012	d <sub>A</sub> h6	d <sub>3</sub>	l <sub>1</sub>	l <sub>2</sub>	l	TIA70
AFH50140-010	1	6	0,95	1,5	3	50	●
AFH50140-020	2	6	1,95	2,0	5	50	●
AFH50140-030	3	6	2,85	3,0	8	55	●
AFH50140-040	4	6	3,85	4,0	10	55	●
AFH50140-050	5	6	4,85	5,0	13	55	●

P	●
M	
K	
N	
S	
H	●

● Hauptanwendung  
Main application  
Application principale

○ Nebenanwendung  
Secondary application  
Application secondaire

							PG 24
							beschichtet coated revêtu
Schaft DIN 6535HA Shank Tige	d -0,016	d <sub>A</sub> h6	d <sub>3</sub>	l <sub>1</sub>	l <sub>2</sub>	l	TIA70
AFH50140-060	6	6	5,85	6	15	55	●
AFH50140-080	8	8	7,70	8	20	65	●
AFH50140-100	10	10	9,70	10	25	75	●
AFH50140-120	12	12	11,70	12	28	85	●
AFH50140-160	16	16	15,70	16	32	90	●
AFH50140-200	20	20	19,70	20	40	105	●

P	●
M	
K	
N	
S	
H	●

● Hauptanwendung  
Main application  
Application principale

○ Nebenanwendung  
Secondary application  
Application secondaire

Solid carbide end-mill  
Fraise carbure monobloc à tige

## AFH50142-...R...

4 Schneiden, mit Eckenradius / 4 flutes, with corner radius / 4 dents, avec rayon d'angle

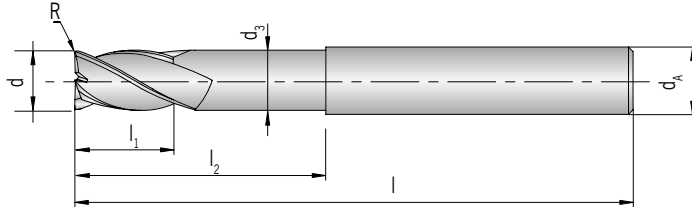

**Feinstkorn**  
Ultra micro granulation  
Grain ultra fin

									PG 24
									beschichtet coated revêtu
Schaft DIN 6535HA Shank Tige	d -0,015	d <sub>A</sub> h6	d <sub>3</sub>	l <sub>1</sub>	l <sub>2</sub>	l	R ±0,015	TIA70	
AFH50142-060R0,5	6	6	5,85	9	20	90	0,5	●	
AFH50142-060R1,0	6	6	5,85	9	20	90	1,0	●	
AFH50142-080R0,5	8	8	7,70	12	25	100	0,5	●	
AFH50142-080R1,0	8	8	7,70	12	25	100	1,0	●	
AFH50142-100R0,5	10	10	9,70	15	32	100	0,5	●	
AFH50142-100R1,0	10	10	9,70	15	32	100	1,0	●	
AFH50142-100R2,0	10	10	9,70	15	32	100	2,0	●	
AFH50142-120R0,5	12	12	11,70	18	38	110	0,5	●	
AFH50142-120R1,0	12	12	11,70	18	38	110	1,0	●	
AFH50142-120R2,0	12	12	11,70	18	38	110	2,0	●	

P	●
M	
K	
N	
S	
H	●

● **Hauptanwendung**  
Main application  
Application principale

○ **Nebenanwendung**  
Secondary application  
Application secondaire

Solid carbide end-mill  
Fraise carbure monobloc à tige

## AFH50146-...R...

4 Schneiden, mit Eckenradius / 4 flutes, with corner radius / 4 dents, avec rayon d'angle

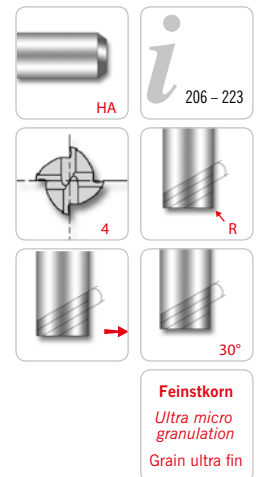
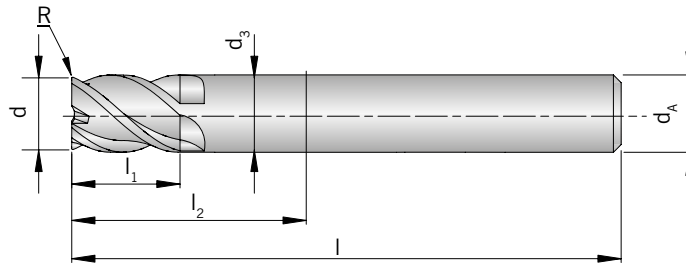

AFH

									PG 24
									beschichtet coated revêtu
Schaft DIN 6535HA Shank Tige	d -0,012	d <sub>A</sub> h6	d <sub>3</sub>	l <sub>1</sub>	l <sub>2</sub>	l	R ±0,01	TIA70	
AFH50146-030AR0,3	3	6	2,85	4	12	55	0,3	●	
AFH50146-030BR0,3	3	6	2,85	4	16	55	0,3	●	
AFH50146-030CR0,3	3	6	2,85	4	20	55	0,3	●	
AFH50146-030DR0,5	3	6	2,85	4	10	55	0,5	●	
AFH50146-030ER0,5	3	6	2,85	4	16	55	0,5	●	
AFH50146-030FR0,5	3	6	2,85	4	20	55	0,5	●	
AFH50146-040AR0,3	4	6	3,85	5	12	55	0,3	●	
AFH50146-040BR0,3	4	6	3,85	5	16	55	0,3	●	
AFH50146-040CR0,3	4	6	3,85	5	20	55	0,3	●	
AFH50146-040DR0,5	4	6	3,85	5	12	55	0,5	●	
AFH50146-040ER0,5	4	6	3,85	5	16	55	0,5	●	
AFH50146-040FR0,5	4	6	3,85	5	20	55	0,5	●	
AFH50146-040GR1,0	4	6	3,85	5	12	55	1,0	●	

P	●
M	
K	
N	
S	
H	●

● Hauptanwendung  
Main application  
Application principale  
○ Nebenanwendung  
Secondary application  
Application secondaire

								PG 24
								beschichtet coated revêtu
Schaft DIN 6535HA Shank Tige	d -0,015	d <sub>A</sub> h6	d <sub>3</sub>	l <sub>1</sub>	l <sub>2</sub>	l	R ±0,015	TiAl70
AFH50146-060AR0,5	6	6	5,85	7	20	60	0,5	●
AFH50146-060BR1,0	6	6	5,85	7	20	60	1,0	●
AFH50146-060CR1,5	6	6	5,85	7	20	60	1,5	●
AFH50146-080AR0,5	8	8	7,70	9	25	60	0,5	●
AFH50146-080BR1,0	8	8	7,70	9	25	60	1,0	●
AFH50146-080CR1,5	8	8	7,70	9	25	60	1,5	●
AFH50146-080DR2,0	8	8	7,70	9	25	60	2,0	●
AFH50146-100AR0,5	10	10	9,70	11	32	70	0,5	●
AFH50146-100BR1,0	10	10	9,70	11	32	70	1,0	●
AFH50146-100CR1,5	10	10	9,70	11	32	70	1,5	●
AFH50146-100DR2,0	10	10	9,70	11	32	70	2,0	●
AFH50146-120AR0,5	12	12	11,70	12	38	80	0,5	●
AFH50146-120BR1,0	12	12	11,70	12	38	80	1,0	●
AFH50146-120CR1,5	12	12	11,70	12	38	80	1,5	●
AFH50146-120DR2,0	12	12	11,70	12	38	80	2,0	●

P	●
M	
K	
N	
S	
H	●

- **Hauptanwendung**  
Main application  
Application principale
- **Nebenanwendung**  
Secondary application  
Application secondaire

Solid carbide end-mill

Fraise carbure monobloc à tige

## AFH50745-...R...

4 Schneiden, mit Eckenradius / 4 flutes, with corner radius / 4 dents, avec rayon d'angle

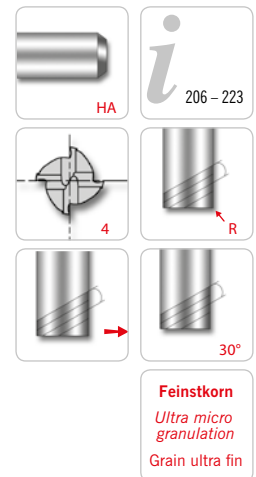
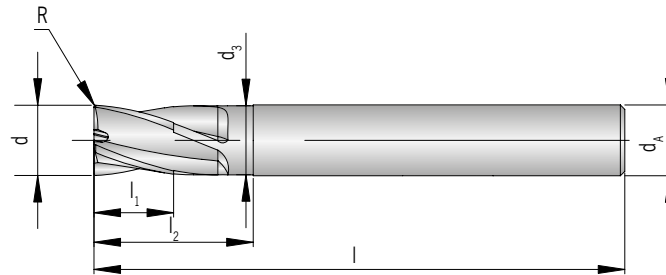

PG 24

beschichtet  
coated  
revêtu

Schaft DIN 6535HA

Shank  
Tige

	d -0,012	d <sub>A</sub> h6	d <sub>3</sub>	l <sub>1</sub>	l <sub>2</sub>	l	R -0,01	TIA70
AFH50745-010R0,1	1,0	6	-	1,5	-	40	0,1	●
AFH50745-015R0,1	1,5	6	-	2,2	-	40	0,1	●
AFH50745-020R0,1	2,0	6	1,95	3,0	6	40	0,1	●
AFH50745-025R0,1	2,5	6	2,40	4,0	6	40	0,1	●
AFH50745-030R0,1	3,0	6	2,85	4,0	7	45	0,1	●
AFH50745-035R0,1	3,5	6	3,35	5,0	9	45	0,1	●
AFH50745-040R0,1	4,0	6	3,85	5,0	9	45	0,1	●
AFH50745-045R0,1	4,5	6	4,35	6,0	10	45	0,1	●
AFH50745-050R0,2	5,0	6	4,85	6,0	11	50	0,2	●

P	●
M	
K	
N	
S	
H	●

● Hauptanwendung  
Main application  
Application principale

○ Nebenanwendung  
Secondary application  
Application secondaire

								PG 24
								beschichtet coated revêtu
Schaft DIN 6535HA Shank Tige	d -0,015	d <sub>A</sub> h6	d <sub>3</sub>	l <sub>1</sub>	l <sub>2</sub>	l	R -0,015	TiAl70
AFH50745-060R0,2	6	6	5,85	7	14	50	0,2	●
AFH50745-080R0,2	8	8	7,70	9	18	60	0,2	●
AFH50745-100R0,2	10	10	9,70	12	25	75	0,2	●
AFH50745-120R0,3	12	12	11,70	15	30	75	0,3	●
AFH50745-160R0,3	16	16	15,70	18	38	90	0,3	●
AFH50745-200R0,3	20	20	19,70	24	45	100	0,3	●

P	●
M	
K	
N	
S	
H	●

- **Hauptanwendung**  
Main application  
Application principale
- **Nebenanwendung**  
Secondary application  
Application secondaire

Solid carbide ball-nose end-mill  
Fraise carbure monobloc hémisphérique

## AFH50341-...

4 Schneiden / 4 flutes / 4 dents

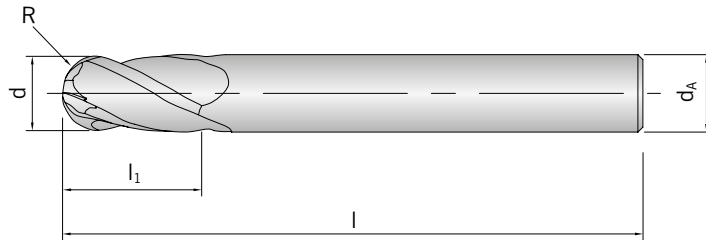

AFH

							PG 24
							beschichtet coated revêtu
Schaft DIN 6535HA Shank Tige	d -0,012	d <sub>A</sub> h6	l <sub>1</sub>	l	R ±0,005	TiAl70	
AFH50341-030	3	6	8	60	1,5	●	
AFH50341-040	4	6	8	70	2,0	●	
AFH50341-050	5	6	10	80	2,5	●	

● Hauptanwendung Main application Application principale	P	●
	M	
	K	
	N	
○ Nebenanwendung Secondary application Application secondaire	S	
	H	●

							PG 24
							beschichtet coated revêtu
Schaft DIN 6535HA Shank Tige	d -0,015	d <sub>A</sub> h6	l <sub>1</sub>	l	R ±0,010	TiAl70	
AFH50341-060	6	6	12	90	3	●	
AFH50341-080	8	8	14	100	4	●	
AFH50341-100	10	10	18	100	5	●	
AFH50341-120	12	12	22	110	6	●	
AFH50341-160	16	16	30	140	8	●	
AFH50341-200	20	20	38	160	10	●	

● Hauptanwendung Main application Application principale	P	●
	M	
	K	
	N	
○ Nebenanwendung Secondary application Application secondaire	S	
	H	●



## AFH50865-...R...

6 Schneiden, mit Eckenradius / 6 flutes, with corner radius / 6 dents, avec rayon d'angle

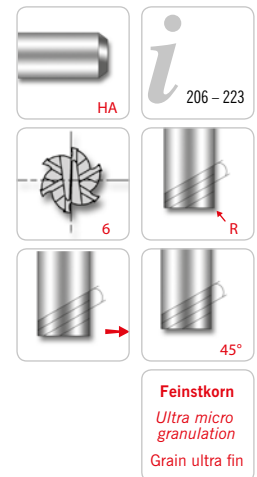
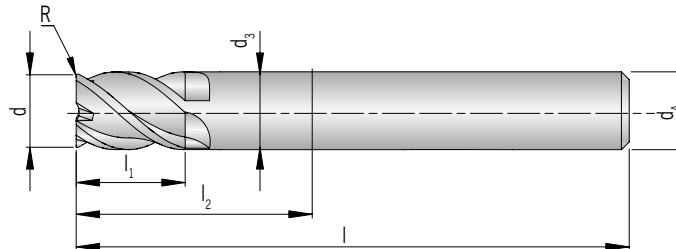

									PG 24
									beschichtet coated revêtu
Schaft DIN 6535HA Shank Tige	d -0,02	d <sub>A</sub> h6	d <sub>3</sub>	l <sub>1</sub>	l <sub>2</sub>	l	R ±0,015	TIA70	
AFH50865-060AR0,25	6	6	5,85	6	14	50	0,25	●	
AFH50865-060BR0,5	6	6	5,85	6	14	50	0,50	●	
AFH50865-060CR0,5	6	6	-	13	-	70	0,50	●	
AFH50865-060DR0,5 <sup>1)</sup>	6	6	-	26	-	70	0,50	●	
AFH50865-080AR0,5	8	8	7,70	8	24	60	0,50	●	
AFH50865-080BR0,5	8	8	-	19	-	90	0,50	●	
AFH50865-080CR0,5 <sup>1)</sup>	8	8	-	36	-	90	0,50	●	
AFH50865-100AR0,5	10	10	-	22	-	100	0,50	●	
AFH50865-100BR1,0	10	10	9,70	10	30	70	1,00	●	
AFH50865-100CR1,0	10	10	-	22	-	100	1,00	●	
AFH50865-100DR1,0 <sup>1)</sup>	10	10	-	46	-	100	1,00	●	
AFH50865-120AR0,5	12	12	-	26	-	110	0,50	●	
AFH50865-120BR1,0	12	12	11,70	12	30	75	1,00	●	
AFH50865-120CR1,0	12	12	-	26	-	110	1,00	●	
AFH50865-120DR1,0 <sup>1)</sup>	12	12	-	56	-	110	1,00	●	
AFH50865-160AR1,0	16	16	-	32	-	130	1,00	●	
AFH50865-160BR1,5	16	16	-	32	-	130	1,50	●	
AFH50865-160CR1,5 <sup>1)</sup>	16	16	-	66	-	130	1,50	●	
AFH50865-200AR1,0	20	20	-	38	-	140	1,00	●	
AFH50865-200BR1,5	20	20	-	38	-	140	1,50	●	
AFH50865-200CR2,0 <sup>1)</sup>	20	20	-	38	-	140	2,00	●	
AFH50865-200DR2,0	20	20	-	76	-	140	2,00	●	

1) Toleranz für d von -0,03  
Tolerance for d of -0.03  
Tolérance de - 0,03 pour le diamètre

P	●
M	
K	
N	
S	
H	●

● Hauptanwendung  
Main application  
Application principale  
○ Nebenanwendung  
Secondary application  
Application secondaire

Solid carbide end-mill  
Fraise carbure monobloc à tige

## AFH508.1-...

6-8 Schneiden, lange Ausführung / 6-8 flutes, long design / 6-8 dents, version longue

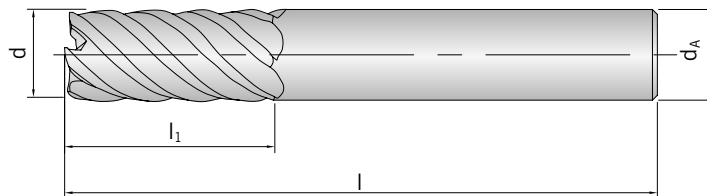

AFH

							PG 24
							beschichtet coated revêtu
Schaft DIN 6535HA Shank Tige	d -0,02	d <sub>A</sub> h6	l <sub>1</sub>	l	z	TIA70	
AFH50861-060	6	6	13	57	6	●	
AFH50861-080	8	8	19	63	6	●	
AFH50861-100	10	10	22	72	6	●	
AFH50861-120	12	12	26	83	6	●	
AFH50861-140	14	14	26	83	6	●	
AFH50861-160	16	16	32	92	6	●	
AFH50881-180	18	18	32	92	8	●	
AFH50881-200	20	20	38	104	8	●	
AFH50881-250	25	25	44	104	8	●	

P	●
M	
K	
N	
S	
H	●

● **Hauptanwendung**  
Main application  
Application principale

○ **Nebenanwendung**  
Secondary application  
Application secondaire

Solid carbide end-mill  
Fraise carbure monobloc à tige

## AFH508.2-...

6-8 Schneiden, extra lange Ausführung / 6-8 flutes, extra long design / 6-8 dents, version extra longue

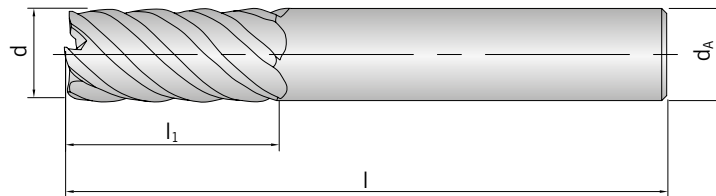

							PG 24
							beschichtet coated revêtu
Schaft DIN 6535HA Shank Tige	d -0,03	d <sub>A</sub> h6	l <sub>1</sub>	l	z	TIA70	
AFH50862-060	6	6	26	70	6	●	
AFH50862-080	8	8	36	90	6	●	
AFH50862-100	10	10	46	100	6	●	
AFH50862-120	12	12	56	110	6	●	
AFH50862-160	16	16	66	130	6	●	
AFH50882-200	20	20	76	140	8	●	
AFH50882-250	25	25	92	180	8	●	

P	●
M	
K	
N	
S	
H	●

● Hauptanwendung  
Main application  
Application principale

○ Nebenanwendung  
Secondary application  
Application secondaire

AFH

Solid carbide high-feed end-mill

Fraise carbure monobloc à tige torique / Fraise haute avance

## AFH50746-...R...

4 Schneiden, kurze Ausführung, mit Eckenradius / 4 flutes, short design, with corner radius / 4 dents, version courte avec rayon d'angle

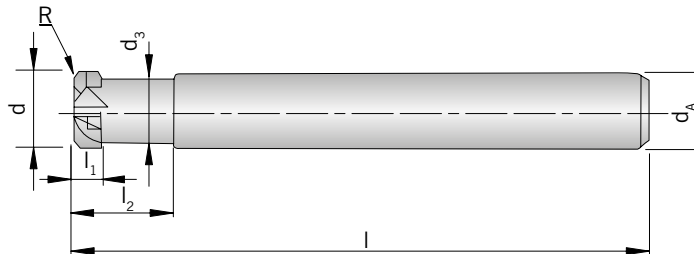
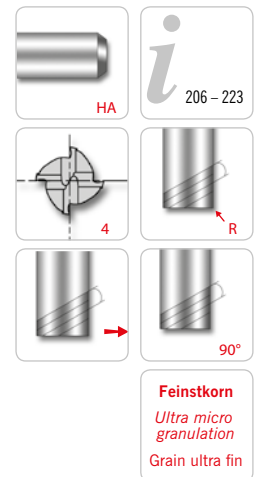

PG 24

beschichtet  
coated  
revêtu

Schaft DIN 6535HA

Shank  
Tige

	d -0,02	d <sub>A</sub> h6	d <sub>3</sub>	l <sub>1</sub>	l <sub>2</sub>	l	R ± 0,005	TIA70
AFH50746-020 R0.5	2	6	1,8	1,0	6	50	0,5	●
AFH50746-030 R0.5	3	6	2,8	1,2	8	50	0,5	●
AFH50746-040 R0.5	4	6	3,8	1,5	10	50	0,5	●
AFH50746-060 R0.5	6	6	5,4	2,5	12	60	0,5	●
AFH50746-060 R1.0	6	6	5,4	2,5	12	60	1,0	●
AFH50746-080 R1.0	8	8	7,2	3,5	16	60	1,0	●
AFH50746-080 R2.0	8	8	7,2	3,5	16	60	2,0	●
AFH50746-100 R1.0	10	10	9,0	4,0	20	70	1,0	●
AFH50746-100 R2.0	10	10	9,0	4,0	20	70	2,0	●
AFH50746-120 R2.0	12	12	11,0	5,0	25	80	2,0	●
AFH50746-120 R3.0	12	12	11,0	5,0	25	80	3,0	●

P	●
M	
K	
N	
S	
H	●

● Hauptanwendung  
Main application  
Application principale

○ Nebenanwendung  
Secondary application  
Application secondaire

Solid carbide high-feed end-mill

Fraise carbure monobloc à tige torique / Fraise haute avance

## AFH50741-...R...

4 Schneiden, lange Ausführung, mit Eckenradius / 4 flutes, long design, with corner radius / 4 dents, version longue, avec rayon d'angle

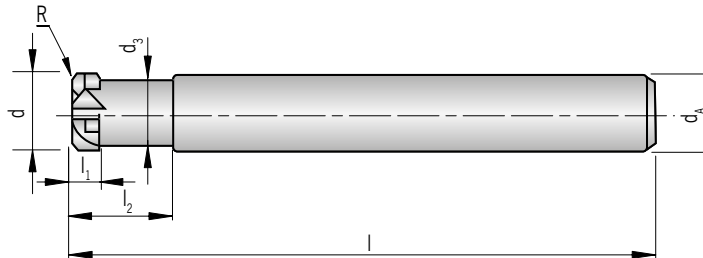
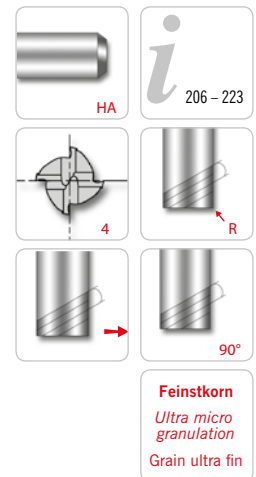

								PG 24
								beschichtet coated revêtu
Schaft DIN 6535HA Shank Tige	d -0,02	d <sub>A</sub> h6	d <sub>3</sub>	l <sub>1</sub>	l <sub>2</sub>	l	R ± 0,005	TiAl70
AFH50741-020 R0.5	2	6	1,8	1,0	6	70	0,5	●
AFH50741-030 R0.5	3	6	2,8	1,2	8	70	0,5	●
AFH50741-040 R0.5	4	6	3,8	1,5	10	70	0,5	●
AFH50741-050 R0.5	5	6	4,6	2,0	10	70	0,5	●
AFH50741-060 R0.5	6	6	5,4	2,5	12	90	0,5	●
AFH50741-060 R1.0	6	6	5,4	2,5	12	90	1,0	●
AFH50741-080 R1.0	8	8	7,2	3,5	16	100	1,0	●
AFH50741-080 R2.0	8	8	7,2	3,5	16	100	2,0	●
AFH50741-100 R1.0	10	10	9,0	4,0	20	100	1,0	●
AFH50741-100 R2.0	10	10	9,0	4,0	20	100	2,0	●
AFH50741-120 R2.0	12	12	11,0	5,0	25	110	2,0	●
AFH50741-120 R3.0	12	12	11,0	5,0	25	110	3,0	●
AFH50741-160 R3.0	16	16	15,0	6,5	30	130	3,0	●

P	●
M	
K	
N	
S	
H	●

● Hauptanwendung  
Main application  
Application principale

○ Nebenanwendung  
Secondary application  
Application secondaire

AFH

→ Radius / radius / rayon **0,1 mm – D 4,0 mm MINI Z2**

Fräser End-mill Fraise	Stahl Steel Acier					Stahl Steel Acier					Stahl Steel Acier					Stahl gehärtet hardened steel Acier trempé					Stahl gehärtet hardened steel Acier trempé						
	≤ 800 N/mm² (≥ 22 HRC)					≤ 1100 N/mm² (25-35 HRC)					≤ 1400 N/mm² (35-45 HRC)					≤ 1950 N/mm² (45-55 HRC)					≥ 2000 N/mm² (55-70 HRC)						
D	R	I <sub>1</sub>	a <sub>p</sub>	n	f <sub>z</sub>	v <sub>f</sub>	a <sub>p</sub>	n	f <sub>z</sub>	v <sub>f</sub>	a <sub>p</sub>	n	f <sub>z</sub>	v <sub>f</sub>	a <sub>p</sub>	n	f <sub>z</sub>	v <sub>f</sub>	a <sub>p</sub>	n	f <sub>z</sub>	v <sub>f</sub>	a <sub>p</sub>	n	f <sub>z</sub>	v <sub>f</sub>	
[mm]	[mm]	[mm]	[mm]	[mm]	[mm]	[mm/min]	[mm]	[mm]	[mm]	[mm/min]	[mm]	[mm]	[mm]	[mm/min]	[mm]	[mm]	[mm]	[mm/min]	[mm]	[mm]	[mm]	[mm/min]	[mm]	[mm]	[mm]	[mm]	[mm/min]
0,10	-	0,15	0,006	50000	0,011	1050	0,005	50000	0,011	1050	0,004	50000	0,008	780	0,003	45000	0,007	594	0,002	42000	0,006	479					
0,10	-	0,20	0,006	50000	0,011	1050	0,005	50000	0,011	1050	0,004	50000	0,008	780	0,003	45000	0,007	594	0,002	42000	0,006	479					
0,20	-	0,30	0,020	45000	0,016	1418	0,018	40500	0,016	1276	0,014	38250	0,012	895	0,010	33750	0,010	668	0,008	31500	0,009	539					
0,20	-	0,40	0,020	45000	0,016	1418	0,018	40500	0,016	1276	0,014	38250	0,012	895	0,010	33750	0,010	668	0,008	31500	0,009	539					
0,30	-	0,45	0,021	40000	0,016	1260	0,019	36000	0,016	1134	0,015	34000	0,012	796	0,011	30000	0,010	594	0,008	28000	0,009	479					
0,30	-	0,60	0,021	40000	0,016	1260	0,019	36000	0,016	1134	0,015	34000	0,012	796	0,011	30000	0,010	594	0,008	28000	0,009	479					
0,40	-	0,60	0,040	32000	0,021	1344	0,036	28800	0,021	1210	0,028	27200	0,016	849	0,020	24000	0,013	634	0,016	22400	0,011	511					
0,40	-	0,80	0,040	32000	0,021	1344	0,036	28800	0,021	1210	0,028	27200	0,016	849	0,020	24000	0,013	634	0,016	22400	0,011	511					
0,50	-	0,70	0,050	32000	0,021	1344	0,045	28800	0,021	1210	0,035	27200	0,016	849	0,025	24000	0,013	634	0,020	22400	0,011	511					
0,50	0,05	0,70	0,050	32000	0,021	1344	0,045	28800	0,021	1210	0,035	27200	0,016	849	0,025	24000	0,013	634	0,020	22400	0,011	511					
0,50	-	1,00	0,050	32000	0,021	1344	0,045	28800	0,021	1210	0,035	27200	0,016	849	0,025	24000	0,013	634	0,020	22400	0,011	511					
0,50	0,05	1,00	0,050	32000	0,021	1344	0,045	28800	0,021	1210	0,035	27200	0,016	849	0,025	24000	0,013	634	0,020	22400	0,011	511					
0,60	-	0,90	0,042	32000	0,026	1680	0,038	28800	0,026	1512	0,029	27200	0,020	1061	0,021	24000	0,017	792	0,017	22400	0,014	638					
0,60	0,05	0,90	0,042	32000	0,026	1680	0,038	28800	0,026	1512	0,029	27200	0,020	1061	0,021	24000	0,017	792	0,017	22400	0,014	638					
0,60	-	1,20	0,042	32000	0,026	1680	0,038	28800	0,026	1512	0,029	27200	0,020	1061	0,021	24000	0,017	792	0,017	22400	0,014	638					
0,60	0,05	1,20	0,042	32000	0,026	1680	0,038	28800	0,026	1512	0,029	27200	0,020	1061	0,021	24000	0,017	792	0,017	22400	0,014	638					
0,70	-	1,40	0,049	28800	0,024	1382	0,044	25920	0,024	1244	0,034	24480	0,020	955	0,025	21600	0,017	713	0,020	20160	0,014	575					
0,70	0,05	1,40	0,049	28800	0,024	1382	0,044	25920	0,024	1244	0,034	24480	0,020	955	0,025	21600	0,017	713	0,020	20160	0,014	575					
0,70	0,10	1,00	0,049	28800	0,024	1382	0,044	25920	0,024	1244	0,034	24480	0,020	955	0,025	21600	0,017	713	0,020	20160	0,014	575					
0,80	-	1,20	0,056	32000	0,026	1680	0,050	28800	0,026	1512	0,039	27200	0,020	1061	0,028	24000	0,017	792	0,022	22400	0,014	638					
0,80	0,05	1,20	0,056	32000	0,026	1680	0,050	28800	0,026	1512	0,039	27200	0,020	1061	0,028	24000	0,017	792	0,022	22400	0,014	638					
0,80	-	1,60	0,056	32000	0,026	1680	0,050	28800	0,026	1512	0,039	27200	0,020	1061	0,028	24000	0,017	792	0,022	22400	0,014	638					
0,80	0,05	1,60	0,056	32000	0,026	1680	0,050	28800	0,026	1512	0,039	27200	0,020	1061	0,028	24000	0,017	792	0,022	22400	0,014	638					
0,80	0,10	1,20	0,056	32000	0,026	1680	0,050	28800	0,026	1512	0,039	27200	0,020	1061	0,028	24000	0,017	792	0,022	22400	0,014	638					
0,90	-	2,00	0,036	28800	0,024	1382	0,032	25920	0,024	1244	0,025	24480	0,020	955	0,018	21600	0,017	713	0,014	20160	0,014	575					
0,90	0,05	2,00	0,036	28800	0,024	1382	0,032	25920	0,024	1244	0,025	24480	0,020	955	0,018	21600	0,017	713	0,014	20160	0,014	575					
1,00	-	1,50	0,010	28800	0,032	1814	0,090	25920	0,032	1633	0,070	24480	0,023	1146	0,050	21600	0,020	855	0,040	20160	0,017	689					
1,00	0,10	1,50	0,010	28800	0,032	1814	0,090	25920	0,032	1633	0,070	24480	0,023	1146	0,050	21600	0,020	855	0,040	20160	0,017	689					
1,00	0,10	1,80	0,010	28800	0,032	1814	0,090	25920	0,032	1633	0,070	24480	0,023	1146	0,050	21600	0,020	855	0,040	20160	0,017	689					
1,20	0,10	1,80	0,084	25600	0,032	1613	0,076	23040	0,032	1452	0,059	21760	0,023	1018	0,042	19200	0,020	760	0,034	17920	0,017	613					
1,50	-	1,70	0,110	22400	0,032	1411	0,099	20160	0,032	1270	0,077	19040	0,023	891	0,055	16800	0,020	665	0,044	15680	0,017	536					
1,50	-	2,30	0,110	22400	0,032	1411	0,099	20160	0,032	1270	0,077	19040	0,023	891	0,055	16800	0,020	665	0,044	15680	0,017	536					
1,50	0,10	2,20	0,110	22400	0,032	1411	0,099	20160	0,032	1270	0,077	19040	0,023	891	0,055	16800	0,020	665	0,044	15680	0,017	536					
1,50	0,15	2,20	0,110	22400	0,032	1411	0,099	20160	0,032	1270	0,077	19040	0,023	891	0,055	16800	0,020	665	0,044	15680	0,017	536					
1,50	0,20	2,50	0,110	22400	0,032	1411	0,099	20160	0,032	1270	0,077	19040	0,023	891	0,055	16800	0,020	665	0,044	15680	0,017	536					
2,00	-	2,00	0,200	16800	0,042	1411	0,180	15120	0,042	1270	0,140	14280	0,031	891	0,100	12600	0,026	665	0,080	11760	0,023	536					
2,00	-	3,00	0,200	16800	0,042	1411	0,180	15120	0,042	1270	0,140	14280	0,031	891	0,100	12600	0,026	665	0,080	11760	0,023	536					
2,00	0,10	3,00	0,200	16800	0,042	1411	0,180	15120	0,042	1270	0,140	14280	0,031	891	0,100	12600	0,026	665	0,080	11760	0,023	536					
2,00	0,15	2,20	0,200	16800	0,042	1411	0,180	15120	0,042	1270	0,140	14280	0,031	891	0,100	12600	0,026	665	0,080	11760	0,023	536					
2,00	0,20	3,00	0,200	16800	0,042	1411	0,180	15120	0,042	1270	0,140	14280	0,031	891	0,100	12600	0,026	665	0,080	11760	0,023	536					
2,00	0,30	3,00	0,200	16800	0,042	1411	0,180	15120	0,042	1270	0,140	14280	0,031	891	0,100	12600	0,026	665	0,080	11760	0,023	536					
2,00	0,50	3,00	0,200	16800	0,042	1411	0,180	15120	0,042	1270	0,140	14280	0,031	891	0,100	12600	0,026	665	0,080	11760	0,023	536					
2,50	-	2,50	0,180	14400	0,053	1512	0,162	12960	0,053	1361	0,126	12240	0,039	955	0,090	10800	0,033	713	0,072	10080	0,029	575					
2,50	0,10	4,00	0,180	14400	0,053	1512	0,162	12960	0,053	1361	0,126	12240	0,039	955	0,090	10800	0,033	713	0,072	10080	0,029	575					
3,00	-	3,00	0,300	12800	0,053	1344	0,270	11520	0,053	1210	0,210	10880	0,039	849	0,150	9600	0,033	634	0,120	8960	0,029	511					
3,00	-	4,50	0,300	12800	0,053	1344	0,270	11520	0,053	1210	0,210	10880	0,039	849	0,150	9600	0,033	634	0,120	8960	0,029	511					
3,00	0,10	4,00	0,300	12800	0,053	1344	0,270	11520	0,053	1210	0,210	10880	0,039	849	0,150	9600	0,033	634	0,120								

## Umfangfräsen / Contour milling / Contournage

55–70 HRC

Ø	Stahl gehärtet hardened steel Acier trempé (≤ 55 HRC)			Stahl gehärtet hardened steel Acier trempé (55–62 HRC)			Stahl gehärtet hardened steel Acier trempé (62–70 HRC)		
	D [mm]	n [min <sup>-1</sup> ]	v <sub>f</sub> [mm/min]	a <sub>e</sub> [mm]	n [min <sup>-1</sup> ]	v <sub>f</sub> [mm/min]	a <sub>e</sub> [mm]	n [min <sup>-1</sup> ]	v <sub>f</sub> [mm/min]
1,0	40000	1200	0,05	40000	800	0,03	32000	500	0,02
2,0	40000	2000	0,10	24000	1000	0,05	16000	600	0,05
3,0	32000	3800	0,20	16000	1900	0,10	11000	1200	0,05
4,0	24000	4400	0,20	12000	2200	0,10	8000	1300	0,05
6,0	16000	5800	0,30	8000	2900	0,20	5300	1800	0,10
8,0	12000	5800	0,40	6000	2900	0,20	4000	1800	0,10
10,0	9600	5800	0,50	4800	2900	0,30	3200	1800	0,20
12,0	8000	4800	0,60	4000	2400	0,30	2700	1500	0,20
16,0	6000	3600	0,80	3000	1800	0,50	2000	1100	0,30
20,0	4800	2900	1,00	2400	1400	0,50	1600	880	0,30

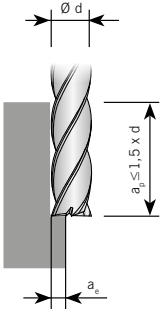
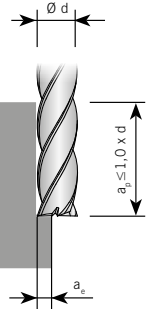



AFH

## Nutfräsen / Slot milling / Rainurage

35–70 HRC

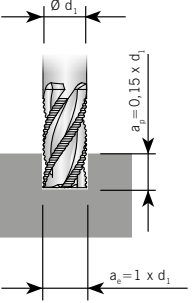
Ø	Stahl Steel Acier ≤ 1400 N/mm <sup>2</sup> (35-45 HRC)					Stahl gehärtet hardened steel Acier trempé ≤ 1950 N/mm <sup>2</sup> (45-55 HRC)					Stahl gehärtet hardened steel Acier trempé > 2000 N/mm <sup>2</sup> (55-70 HRC)				
	D [mm]	a <sub>p</sub> [mm]	a <sub>e</sub> [mm]	n [min <sup>-1</sup> ]	f <sub>z</sub> [mm]	v <sub>f</sub> [mm/min]	a <sub>p</sub> [mm]	a <sub>e</sub> [mm]	n [min <sup>-1</sup> ]	f <sub>z</sub> [mm]	v <sub>f</sub> [mm/min]	a <sub>p</sub> [mm]	a <sub>e</sub> [mm]	n [min <sup>-1</sup> ]	f <sub>z</sub> [mm]
1,0	0,15	1,0	15000	0,008	240	0,15	1,0	12600	0,004	100	0,15	1,0	6300	0,003	38
2,0	0,30	2,0	7600	0,010	152	0,30	2,0	6400	0,006	76	0,30	2,0	3200	0,006	38
3,0	0,45	3,0	5100	0,015	153	0,45	3,0	4200	0,010	84	0,45	3,0	2100	0,009	38
4,0	0,60	4,0	3800	0,025	190	0,60	4,0	3200	0,018	115	0,60	4,0	1600	0,013	41
5,0	0,75	5,0	3100	0,030	186	0,75	5,0	2500	0,025	125	0,75	5,0	1300	0,018	47
6,0	0,90	6,0	2500	0,038	190	0,90	6,0	2100	0,030	126	0,90	6,0	1100	0,021	46
8,0	1,20	8,0	1900	0,050	190	1,20	8,0	1600	0,040	128	1,20	8,0	800	0,028	45
10,0	1,50	10,0	1500	0,063	189	1,50	10,0	1300	0,050	130	1,50	10,0	600	0,035	42
12,0	1,80	12,0	1300	0,070	182	1,80	12,0	1100	0,055	121	1,80	12,0	500	0,039	39
16,0	2,40	16,0	955	0,085	162	2,40	16,0	800	0,060	96	2,40	16,0	400	0,043	35
20,0	3,00	20,0	765	0,112	171	3,00	20,0	640	0,070	90	3,00	20,0	340	0,049	35



Hinweis: Grundlage der Berechnung ist Zähnezahl Z2 / Information: Calculation is based on two tooth Z2 / Remarque: Le calcul repose sur deux dents Z2

Recommended cutting data full radius end-mill

Valeurs de coupe recommandées fraise à rayon complet en carbure monobloc

→ Radius / radius / rayon 0,05 mm – 1,5 mm

Fräser End-mill	Stahl Steel Acier						Stahl Steel Acier					Stahl Steel Acier					Stahl gehärtet hardened steel Acier trempé					Stahl gehärtet hardened steel Acier trempé						
	≤ 800 N/mm <sup>2</sup> (≥ 22 HRC)						≤ 1100 N/mm <sup>2</sup> (25-35 HRC)					≤ 1400 N/mm <sup>2</sup> (35-45 HRC)					≤ 1950 N/mm <sup>2</sup> (45-55 HRC)					≥ 2000 N/mm <sup>2</sup> (55-70 HRC)						
	D	R	l <sub>1</sub>	a <sub>p</sub>	a <sub>e</sub>	n	f <sub>z</sub>	v <sub>f</sub>	a <sub>p</sub>	a <sub>e</sub>	n	f <sub>z</sub>	v <sub>f</sub>	a <sub>p</sub>	a <sub>e</sub>	n	f <sub>z</sub>	v <sub>f</sub>	a <sub>p</sub>	a <sub>e</sub>	n	f <sub>z</sub>	v <sub>f</sub>	a <sub>p</sub>	a <sub>e</sub>	n	f <sub>z</sub>	v <sub>f</sub>
[mm]	[mm]	[mm]	[mm]	[mm]	[mm]	[mm]	[mm/min]	[mm]	[mm]	[mm]	[mm]	[mm/min]	[mm]	[mm]	[mm]	[mm]	[mm/min]	[mm]	[mm]	[mm]	[mm]	[mm/min]	[mm]	[mm]	[mm]	[mm]	[mm]	[mm/min]
0,10	0,05	0,10	0,008	0,024	50000	0,015	1500	0,007	0,022	50000	0,015	1500	0,006	0,019	50000	0,014	1350	0,005	0,016	45000	0,012	1080	0,005	0,014	42000	0,011	882	
0,10	0,05	0,20	0,008	0,024	50000	0,015	1500	0,007	0,022	50000	0,015	1500	0,006	0,019	50000	0,014	1350	0,005	0,016	45000	0,012	1080	0,005	0,014	42000	0,011	882	
0,20	0,10	0,20	0,020	0,060	50000	0,023	2250	0,018	0,054	45000	0,023	2025	0,016	0,048	42500	0,020	1721	0,013	0,039	37500	0,018	1350	0,012	0,036	35000	0,016	1103	
0,20	0,10	0,30	0,020	0,060	50000	0,023	2250	0,018	0,054	45000	0,023	2025	0,016	0,048	42500	0,020	1721	0,013	0,039	37500	0,018	1350	0,012	0,036	35000	0,016	1103	
0,30	0,15	0,30	0,021	0,063	50000	0,023	2250	0,019	0,057	45000	0,023	2025	0,017	0,050	42500	0,020	1721	0,014	0,041	37500	0,018	1350	0,013	0,038	35000	0,016	1103	
0,30	0,15	0,50	0,021	0,063	50000	0,023	2250	0,019	0,057	45000	0,023	2025	0,017	0,050	42500	0,020	1721	0,014	0,041	37500	0,018	1350	0,013	0,038	35000	0,016	1103	
0,40	0,20	0,40	0,040	0,120	40000	0,030	2400	0,036	0,108	36000	0,030	2160	0,032	0,096	34000	0,027	1836	0,026	0,078	30000	0,024	1440	0,024	0,072	28000	0,021	1176	
0,40	0,20	0,60	0,040	0,120	40000	0,030	2400	0,036	0,108	36000	0,030	2160	0,032	0,096	34000	0,027	1836	0,026	0,078	30000	0,024	1440	0,024	0,072	28000	0,021	1176	
0,50	0,25	0,40	0,045	0,135	40000	0,030	2400	0,041	0,122	36000	0,030	2160	0,036	0,108	34000	0,027	1836	0,029	0,088	30000	0,024	1440	0,027	0,081	28000	0,021	1176	
0,50	0,25	0,50	0,045	0,135	40000	0,030	2400	0,041	0,122	36000	0,030	2160	0,036	0,108	34000	0,027	1836	0,029	0,088	30000	0,024	1440	0,027	0,081	28000	0,021	1176	
0,60	0,30	0,50	0,042	0,126	40000	0,038	3000	0,038	0,113	36000	0,038	2700	0,034	0,101	34000	0,034	2295	0,027	0,082	30000	0,030	1800	0,025	0,076	28000	0,026	1470	
0,60	0,30	0,60	0,042	0,126	40000	0,038	3000	0,038	0,113	36000	0,038	2700	0,034	0,101	34000	0,034	2295	0,027	0,082	30000	0,030	1800	0,025	0,076	28000	0,026	1470	
0,60	0,30	0,90	0,042	0,126	40000	0,038	3000	0,038	0,113	36000	0,038	2700	0,034	0,101	34000	0,034	2295	0,027	0,082	30000	0,030	1800	0,025	0,076	28000	0,026	1470	
0,70	0,35	1,10	0,080	0,240	40000	0,038	3000	0,072	0,216	36000	0,038	2700	0,064	0,192	34000	0,034	2295	0,052	0,156	30000	0,030	1800	0,048	0,144	28000	0,026	1470	
0,80	0,40	0,60	0,080	0,240	40000	0,038	3000	0,072	0,216	36000	0,038	2700	0,064	0,192	34000	0,034	2295	0,052	0,156	30000	0,030	1800	0,048	0,144	28000	0,026	1470	
0,80	0,40	0,80	0,080	0,240	40000	0,038	3000	0,072	0,216	36000	0,038	2700	0,064	0,192	34000	0,034	2295	0,052	0,156	30000	0,030	1800	0,048	0,144	28000	0,026	1470	
0,80	0,40	1,20	0,080	0,240	40000	0,038	3000	0,072	0,216	36000	0,038	2700	0,064	0,192	34000	0,034	2295	0,052	0,156	30000	0,030	1800	0,048	0,144	28000	0,026	1470	
0,90	0,45	1,40	0,100	0,300	36000	0,045	3240	0,090	0,270	32400	0,045	2916	0,080	0,240	30600	0,041	2479	0,065	0,195	27000	0,036	1944	0,060	0,180	25200	0,032	1588	
1,00	0,50	0,80	0,100	0,300	36000	0,045	3240	0,090	0,270	32400	0,045	2916	0,080	0,240	30600	0,041	2479	0,065	0,195	27000	0,036	1944	0,060	0,180	25200	0,032	1588	
1,00	0,50	1,00	0,100	0,300	36000	0,045	3240	0,090	0,270	32400	0,045	2916	0,080	0,240	30600	0,041	2479	0,065	0,195	27000	0,036	1944	0,060	0,180	25200	0,032	1588	
1,00	0,50	1,50	0,100	0,300	36000	0,045	3240	0,090	0,270	32400	0,045	2916	0,080	0,240	30600	0,041	2479	0,065	0,195	27000	0,036	1944	0,060	0,180	25200	0,032	1588	
1,20	0,60	1,00	0,040	0,120	28800	0,041	2333	0,036	0,108	25920	0,041	2100	0,032	0,096	24480	0,041	1983	0,026	0,078	21600	0,036	1555	0,024	0,072	20160	0,032	1270	
1,20	0,60	1,20	0,040	0,120	28800	0,041	2333	0,036	0,108	25920	0,041	2100	0,032	0,096	24480	0,041	1983	0,026	0,078	21600	0,036	1555	0,024	0,072	20160	0,032	1270	
1,50	0,75	1,20	0,100	0,300	28000	0,045	2520	0,090	0,270	25200	0,045	2268	0,080	0,240	23800	0,041	1928	0,065	0,195	21000	0,036	1512	0,060	0,180	19600	0,032	1235	
1,50	0,75	1,50	0,100	0,300	28000	0,045	2520	0,090	0,270	25200	0,045	2268	0,080	0,240	23800	0,041	1928	0,065	0,195	21000	0,036	1512	0,060	0,180	19600	0,032	1235	
1,50	0,75	2,00	0,100	0,300	28000	0,045	2520	0,090	0,270	25200	0,045	2268	0,080	0,240	23800	0,041	1928	0,065	0,195	21000	0,036	1512	0,060	0,180	19600	0,032	1235	
2,00	1,00	1,60	0,140	0,420	21000	0,075	3150	0,126	0,378	18900	0,075	2835	0,112	0,336	17850	0,075	2678	0,091	0,273	15750	0,060	1890	0,084	0,253	14700	0,053	1544	
2,00	1,00	2,00	0,140	0,420	21000	0,075	3150	0,126	0,378	18900	0,075	2835	0,112	0,336	17850	0,075	2678	0,091	0,273	15750	0,060	1890	0,084	0,253	14700	0,053	1544	
2,00	1,00	2,50	0,140	0,420	21000	0,075	3150	0,126	0,378	18900	0,075	2835	0,112	0,336	17850	0,075	2678	0,091	0,273	15750	0,060	1890	0,084	0,253	14700	0,053	1544	
2,50	1,25	3,00	0,140	0,420	21000	0,075	3150	0,126	0,378	18900	0,075	2835	0,112	0,336	17850	0,075	2678	0,091	0,273	15750	0,060	1890	0,084	0,253	14700	0,053	1544	
3,00	1,50	2,40	0,210	0,630	14400	0,068	1944	0,189	0,567	12960	0,068	1750	0,168	0,504	12240	0,069	1652	0,137	0,410	10800	0,060	1296	0,126	0,380	10080	0,053	1058	
3,00	1,50	3,00	0,210	0,630	14400	0,068	1944	0,189	0,567	12960	0,068	1750	0,168	0,504	12240	0,069	1652	0,137	0,410	10800	0,060	1296	0,126	0,380	10080	0,053	1058	
3,00	1,50	4,00	0,210	0,630	14400	0,068	1944	0,189	0,567	12960	0,068	1750	0,168	0,504	12240	0,069	1652	0,137	0,410	10800	0,060	1296	0,126	0,380	10080	0,053	1058	
3,00	1,50	8,00	0,080	0,240	14400	0,068	1944	0,072	0,216	12960	0,068	1750	0,064	0,192	12240	0,068	1652	0,052	0,156	10800	0,060	1296	0,048	0,144	10080	0,053	1058	

D = Schaftdurchmesser / Shank diameter / diamètre de tige  
 R = Radius / radius / rayon  
 l<sub>1</sub> = Schneidlänge / Cutting length / longueur de coupe

Achtung: Die Tabellenwerte sind Richtwerte. Es kann notwendig sein, die Werte den jeweiligen Bearbeitungsbedingungen anzupassen.  
 Attention: The recommended cutting data are only approximate values. It may be necessary to adjust them to each individual machining application.  
 Attention: Les valeurs du tableau sont indicatives. Il peut être nécessaire de les adapter aux conditions d'usinage respectives.



Recommended cutting data Solid carbide end-mill

Valeurs de coupe recommandées fraise à queue en carbure monobloc

→ Radius / radius / rayon 0,2 mm – 12,5 mm

Radius radius rayon	Stahl gehärtet hardened steel Acier trempé (≤ 55 HRC)					Stahl gehärtet hardened steel Acier trempé (55–62 HRC)					Stahl gehärtet hardened steel Acier trempé (62–70 HRC)				
	α < 15°		α > 15°			α < 15°		α > 15°			α < 15°		α > 15°		
	R [mm]	n [min <sup>-1</sup> ]	v <sub>f</sub> [mm/min]	n [min <sup>-1</sup> ]	v <sub>f</sub> [mm/min]	a <sub>p</sub> [mm]	n [min <sup>-1</sup> ]	v <sub>f</sub> [mm/min]	n [min <sup>-1</sup> ]	v <sub>f</sub> [mm/min]	a <sub>p</sub> [mm]	n [min <sup>-1</sup> ]	v <sub>f</sub> [mm/min]	n [min <sup>-1</sup> ]	v <sub>f</sub> [mm/min]
2,0	32000	10880	20000	3600	0,15	24000	6200	12000	1900	0,13	12000	2400	8000	800	0,10
2,5	25000	9000	16000	2900	0,20	19000	5300	9600	1700	0,15	9600	2100	6000	600	0,10
3,0	21000	8400	13000	2600	0,25	16000	4800	8000	1600	0,20	8000	1700	5000	600	0,11
4,0	16000	6400	10000	2000	0,30	12000	3600	6000	1200	0,20	6000	1400	4000	480	0,11
4,5	14500	5800	9000	1800	0,40	11000	3300	5400	1080	0,20	5400	1200	3500	450	0,11
5,0	13000	5200	8000	1700	0,50	10000	3200	4800	960	0,20	4800	1100	3000	420	0,12
5,5	11000	4400	7000	1450	0,50	8500	2550	4200	840	0,30	3600	860	2200	310	0,12
6,0	9000	3600	6000	1300	0,50	7000	2200	3600	720	0,30	3000	780	1850	290	0,12
8,0	6000	2400	4000	1000	0,50	5000	1600	2500	500	0,30	2500	650	1500	240	0,15
9,0	5500	2200	3500	875	0,50	4500	1400	2100	420	0,30	2200	570	1250	200	0,15
10,0	4500	1800	3000	780	0,50	4000	1300	1800	360	0,30	1800	470	1000	160	0,15
12,5	3500	1400	2000	520	0,50	3500	1100	1500	300	0,30	1500	390	700	105	0,15

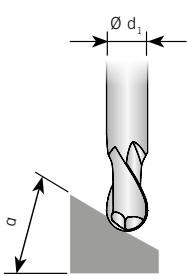

**Hinweis:**

1. Für den Fall, dass keine stabile Werkstück- und Werkzeugspannung vorhanden ist, oder während der Bearbeitung starke Vibrationen auftreten, empfiehlt es sich, die Höhe des Vorschubes und die Drehzahl proportional zu reduzieren.
2. Bei geringeren Schnitttiefen können Drehzahl und Vorschub erhöht werden.
3. „α“ ist der Bearbeitungswinkel.

**Information:**

1. In case of unstable workpiece or tool clamping or heavy vibration during machining, we recommend proportional reduction of feed rate and revolutions.
2. At low cutting depths, revolutions and feed rate can be increased.
3. „α“ is the machine angle.

**Remarque :**

1. Si le serrage pièce et outil n'est pas stable ou si de fortes vibrations surviennent au cours de l'usinage, il est recommandé de réduire proportionnellement la hauteur d'avance et la vitesse de rotation.
2. La vitesse de rotation et l'avance peuvent être augmentées lorsque les profondeurs de coupe sont réduites.
3. « α » est l'angle d'usinage.

AFH

Application Solid carbide - High feed end-mill

Consignes d'utilisation fraise à queue en carbure monobloc et torique - fraise à haute avance

**Feste Radius-Toleranzen, radiale Zustellung**

**0,005 - 0,010 mm**

Tighter radius tolerance

Tolérances fixes de rayon, disposition radiale

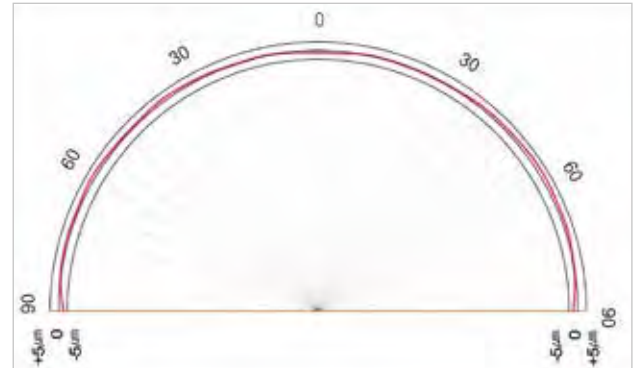
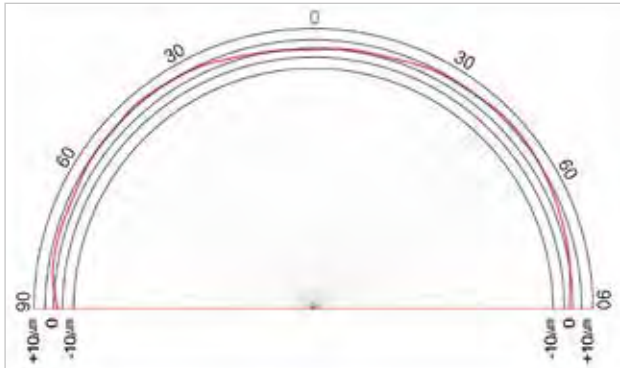

Mit einer Radius-Toleranz von  $\pm 0,005$  mm ist eine höhere Genauigkeit und längere Standzeit garantiert.

Tighter radius tolerance  $\pm 0,005$  mm for a higher accuracy and longer tool life.

Une tolérance de rayon de  $\pm 0,005$  mm garantit une précision plus élevée et une durée de vie prolongée.

**Polierte Oberflächen und speziell entwickelte Beschichtung für beste Zerspanungsergebnisse auch in der Hochgeschwindigkeitsbearbeitung:**

Polished surface and specifically engineered coating for the best results also for high speed machining:

Surfaces polies et revêtement spécialement conçu pour de meilleurs résultats d'usinage même avec l'usinage à grande vitesse :



**Hochgeschwindigkeitsfräser**  
High end-mill  
Fraise à grande vitesse



**Herkömmlicher Fräser**  
Normal end-mill  
Fraise traditionnelle

Speziell entwickelte Hochleistungsbeschichtung – besonders leistungsstark in der Hochgeschwindigkeitsbearbeitung – oder der Bearbeitung hochharter Werkstoffe.

Special coating give consistent result in high speed cutting of high hardness materials.

Revêtement à haute performance spécial : particulièrement performant pour l'usinage à grande vitesse ou pour l'usinage de matériaux très durs.

**Vergleich der Schneidkantenformen: Hochgeschwindigkeitsbearbeitung – normale Bearbeitung**

Comparison of the endteeth shape: High feed end-mill – normal end-mill

Comparaison des formes de tranchants : Usinage à grande vitesse – usinage normal



**Hochgeschwindigkeitsfräser**  
High end-mill  
Fraise à grande vitesse

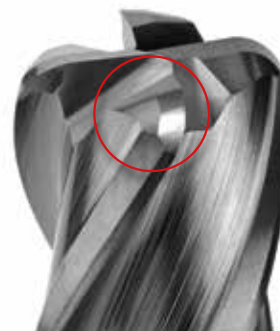

**Herkömmlicher Fräser**  
Normal end-mill  
Fraise traditionnelle

Application Solid carbide - High feed end-mill

Consignes d'utilisation fraise à queue en carbure monobloc et torique - fraise à haute avance

**Vergleich der Schneidkantenformen: Hochgeschwindigkeitsbearbeitung – normale Bearbeitung**

Comparison of the endteeth shape: High feed end-mill – normal end-mill

Comparaison des formes de tranchants : Usinage à grande vitesse – usinage normal



**Extra kurze Schneidenlänge für höchste Stabilität.**  
 Extra short flutes length for high rigidity.  
 Longueur de coupe extra courte pour une stabilité extrême.

**Reduzierter Freiwinkel, kurze Schneide, verstärkter Eckenradius und verkürzte Kantenführung.**

Reduced clearance angles and short strengthens corner radius and reduces chattering.

Angle de dépouille réduit, coupe courte, rayon d'angle renforcé et guidage de bord raccourci.

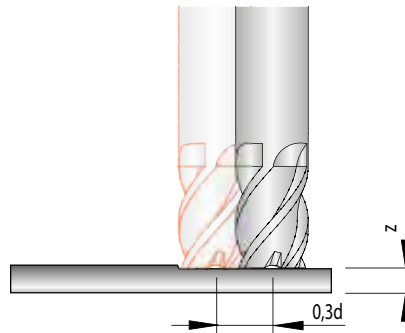
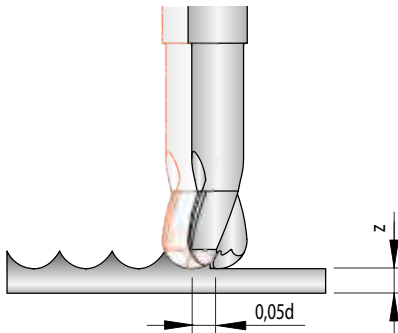

**Anwendungsbeispiel**

Example of performance

Exemple d'application

**(HRC 50-55)**

Werkzeug Item Outil	Größe Size Dimension [mm]	Drehzahl Revolution Vitesse de rotation [U/min] / RPM	Vorschub Feed rate Avance [mm/U]	Zustellung Depth of cut Disposition	
				Z [mm]	X-Y [mm]
<b>Hochgeschwindigkeitsfräser</b> High feed end-mill Fraise à grande vitesse	Ø10 R2	5400	11000	0,2	3,0

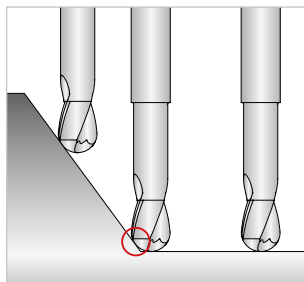

**Radiusfräser**  
Ball-nose milling cutter  
Fraise à rayon

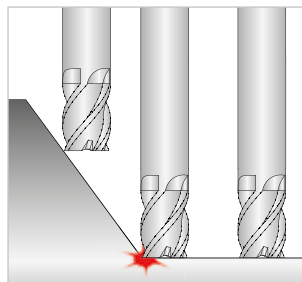

**Schaftfräser**  
End-mill  
Fraise à queue

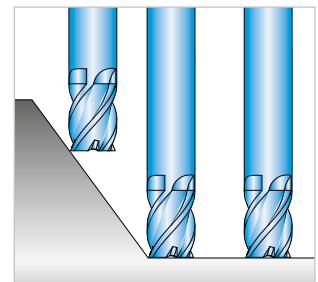

**Torus-Schaftfräser**  
Torus end-mill  
Fraise à queue torique

Richtwerte für den Vorschub pro Zahn  $f_z$  [mm]

ISO	Werkstoff	Festigkeit [N/mm <sup>2</sup> ]	Mittlere Bearbeitung $V_c$ [m/min]	Schrupp- bearbeitung $V_c$ [m/min]	Mittel $d_1 = 2$ mm		Schruppen $d_1 = 2$ mm	
					$a_D$ [mm]	$f_z$ [mm]	$a_D$ [mm]	$f_z$ [mm]
P	Allgemeiner Baustahl	< 800	250-300	150-250	0,05-0,2	0,1-0,2	0,2-0,3	0,2-0,3
	Automatenstahl	< 800	250-300	150-250	0,05-0,2	0,1-0,2	0,2-0,3	0,2-0,3
	Einsatzstahl, unlegiert	< 800	250-300	150-250	0,05-0,2	0,1-0,2	0,2-0,3	0,2-0,3
	Einsatzstahl, legiert	< 1000	200-250	180-200	0,05-0,2	0,1-0,2	0,2-0,3	0,2-0,3
	Vergütungsstahl, unlegiert	< 850	220-250	200-220	0,05-0,2	0,1-0,2	0,2-0,3	0,2-0,3
	Vergütungsstahl, unlegiert	< 1000	220-250	200-220	0,05-0,2	0,1-0,2	0,2-0,3	0,2-0,3
	Vergütungsstahl, legiert	< 800	170-190	170-190	0,05-0,2	0,1-0,2	0,2-0,3	0,2-0,3
	Vergütungsstahl, legiert	< 1300	160-180	160-180	0,05-0,2	0,1-0,2	0,2-0,3	0,2-0,3
	Stahlguss	< 850	220-250	200-220	0,05-0,2	0,1-0,2	0,2-0,3	0,2-0,3
	Nitrierstahl	< 1000	170-190	170-190	0,05-0,2	0,1-0,2	0,2-0,3	0,2-0,3
	Nitrierstahl	< 1200	160-180	160-180	0,05-0,2	0,1-0,2	0,2-0,3	0,2-0,3
	Wälzlagerstahl	< 1200	170-190	170-190	0,05-0,2	0,1-0,2	0,2-0,3	0,2-0,3
	Federstahl	< 1200	100-120	100-120	0,05-0,2	0,1-0,2	0,2-0,3	0,2-0,3
	Schnellarbeitsstahl	< 1300	80-100	80-100	0,05-0,2	0,1-0,2	0,2-0,3	0,2-0,3
	Werkzeugstahl für Kaltarbeit	< 1300	140-180	140-180	0,05-0,2	0,1-0,2	0,2-0,3	0,2-0,3
	Werkzeugstahl für Warmarbeit	< 1300	140-180	140-180	0,05-0,2	0,1-0,2	0,2-0,3	0,2-0,3
M	Stahl und Stahlguss, rostfrei geschwefelt	< 850	110-150	70-110	0,05-0,2	0,1-0,2	0,2-0,3	0,2-0,3
	Nichtrostender Stahl, ferritisch	< 750	110-150	70-110	0,05-0,2	0,1-0,2	0,2-0,3	0,2-0,3
	Nichtrostender Stahl, martensitisch	< 900	110-150	70-110	0,05-0,2	0,1-0,2	0,2-0,3	0,2-0,3
	Nichtrostender Stahl, ferritisch/martensitisch	< 1100	110-150	70-110	0,05-0,2	0,1-0,2	0,2-0,3	0,2-0,3
	Nichtrostender Stahl, austenitisch/ferritisch	< 850	110-150	70-110	0,05-0,2	0,1-0,2	0,2-0,3	0,2-0,3
	Nichtrostender Stahl, austenitisch	< 750	80-110	60-90	0,05-0,2	0,1-0,2	0,2-0,3	0,2-0,3
	Hitzebeständig	< 1100	80-110	60-90	0,05-0,2	0,1-0,2	0,2-0,3	0,2-0,3
K	Grauguss mit Lammellengraphit	100-350	300-350	250-300	0,05-0,2	0,1-0,2	0,2-0,3	0,2-0,3
	Grauguss mit Lammellengraphit	300-1000	180-250	180-250	0,05-0,2	0,1-0,2	0,2-0,3	0,2-0,3
	Kugelgraphitguss	300-500	200-250	150-200	0,05-0,2	0,1-0,2	0,2-0,3	0,2-0,3
	Kugelgraphitguss	550-800	200-250	150-200	0,05-0,2	0,1-0,2	0,2-0,3	0,2-0,3
	Temperguss, weiß	350-450	200-250	150-200	0,05-0,2	0,1-0,2	0,2-0,3	0,2-0,3
	Temperguss, weiß	500-650	200-250	150-200	0,05-0,2	0,1-0,2	0,2-0,3	0,2-0,3
	Temperguss, schwarz	350-450	200-250	150-200	0,05-0,2	0,1-0,2	0,2-0,3	0,2-0,3
	Temperguss, schwarz	500-700	200-250	150-200	0,05-0,2	0,1-0,2	0,2-0,3	0,2-0,3
N	Aluminium (unlegiert, niedrig legiert)	< 350	400-600	400-600	0,05-0,2	0,1-0,2	0,2-0,3	0,2-0,3
	Aluminiumlegierungen < 0,5% Si	< 500	400-600	400-600	0,05-0,2	0,1-0,2	0,2-0,3	0,2-0,3
	Aluminiumlegierungen 0,5 - 10% Si	< 400	400-600	400-600	0,05-0,2	0,1-0,2	0,2-0,3	0,2-0,3
	Aluminiumlegierungen 10 - 15% Si	< 400	400-600	400-600	0,05-0,2	0,1-0,2	0,2-0,3	0,2-0,3
	Aluminiumlegierungen > 15% Si	< 400	400-600	400-600	0,05-0,2	0,1-0,2	0,2-0,3	0,2-0,3
	Kupfer (unlegiert, niedrig legiert)	< 350	300-500	300-500	0,05-0,2	0,1-0,2	0,2-0,3	0,2-0,3
	Kupfer-Knetlegierungen	< 700	300-500	300-500	0,05-0,2	0,1-0,2	0,2-0,3	0,2-0,3
	Kupfer-Sonderlegierungen	< 200 HB	300-500	300-500	0,05-0,2	0,1-0,2	0,2-0,3	0,2-0,3
	Kupfer-Sonderlegierungen	< 300 HB	300-500	300-500	0,05-0,2	0,1-0,2	0,2-0,3	0,2-0,3
	Kupfer-Sonderlegierungen	> 300 HB	300-500	300-500	0,05-0,2	0,1-0,2	0,2-0,3	0,2-0,3
	Messing kurzspanend, Bronze, Rotguss	< 600	300-500	300-500	0,05-0,2	0,1-0,2	0,2-0,3	0,2-0,3
	Messing langspanend	< 600	300-500	300-500	0,05-0,2	0,1-0,2	0,2-0,3	0,2-0,3
	Thermoplaste							
	Duroplaste							
Faserverstärkte Kunststoffe								
Magnesium und Magnesiumlegierungen	< 850							
Graphit								
Wolfram und Wolframlegierungen								
Molybdän und Molybdänlegierungen								
S	Reinnickel							
	Nickellegierungen							
	Nickellegierungen	< 850						
	Nickel-Chromlegierungen		50-80	30-50	0,05-0,2	0,1-0,2	0,2-0,3	0,2-0,3
	Nickel- und Kobaltlegierungen	< 1300						
	Hochwarmfeste Legierungen	< 1300						
	Nickel-Kobalt-(Chrom-)legierungen	< 1400	50-80	30-50	0,05-0,2	0,1-0,2	0,2-0,3	0,2-0,3
	Nickel- und Kobaltlegierungen	< 1300						
	Reintitan	< 900						
Titanlegierungen	< 700	60-80	60-80					
Titanlegierungen	< 1200	40-80	40-80					
H	Stahl gehärtet	< 45 HRC	160-190	160-190	0,05-0,2	0,1-0,2	0,2-0,3	0,2-0,3
		46-55 HRC	150-180	80-120	0,05-0,2	0,1-0,2	0,2-0,3	0,2-0,3
		56-60 HRC	120-150	80-100	0,05-0,2	0,1-0,2	0,2-0,3	0,2-0,25
		61-65 HRC	80-110	60-90	0,05-0,2	0,1-0,2	0,2-0,3	0,2-0,25
		65-70 HRC						

Die Tabellenwerte sind Richtwerte. Es kann notwendig sein, die Werte den jeweiligen Bearbeitungsbedingungen anzupassen.

AFH



Richtwerte für den Vorschub pro Zahn  $f_z$  [mm]

ISO	Werkstoff	Festigkeit [N/mm <sup>2</sup> ]	Mittlere Bearbeitung $V_c$ [m/min]	Schrupp- bearbeitung $V_c$ [m/min]	Mittel $d_1 = 8$ mm		Schruppen $d_1 = 8$ mm	
					$a_D$ [mm]	$f_z$ [mm]	$a_D$ [mm]	$f_z$ [mm]
P	Allgemeiner Baustahl	< 800	250-300	150-250	0,1-0,2	0,1-0,3	0,2-0,3	0,3-0,5
	Automatenstahl	< 800	250-300	150-250	0,1-0,2	0,1-0,3	0,2-0,3	0,3-0,5
	Einsatzstahl, unlegiert	< 800	250-300	150-250	0,1-0,2	0,1-0,3	0,2-0,3	0,3-0,5
	Einsatzstahl, legiert	< 1000	200-250	180-200	0,1-0,2	0,1-0,25	0,2-0,3	0,25-0,4
	Vergütungsstahl, unlegiert	< 850	220-250	200-220	0,1-0,2	0,1-0,25	0,2-0,3	0,25-0,4
	Vergütungsstahl, unlegiert	< 1000	220-250	200-220	0,1-0,2	0,1-0,25	0,2-0,3	0,25-0,4
	Vergütungsstahl, legiert	< 800	170-190	170-190	0,1-0,2	0,1-0,25	0,2-0,3	0,25-0,4
	Vergütungsstahl, legiert	< 1300	160-180	160-180	0,1-0,2	0,1-0,25	0,2-0,3	0,25-0,4
	Stahlguss	< 850	220-250	200-220	0,1-0,2	0,1-0,25	0,2-0,3	0,25-0,4
	Nitrierstahl	< 1000	170-190	170-190	0,1-0,2	0,1-0,25	0,2-0,3	0,25-0,4
	Nitrierstahl	< 1200	160-180	160-180	0,1-0,2	0,1-0,25	0,2-0,3	0,25-0,4
	Wälzlagerstahl	< 1200	170-190	170-190	0,1-0,2	0,1-0,25	0,2-0,3	0,25-0,4
	Federstahl	< 1200	100-120	100-120	0,1-0,2	0,1-0,25	0,2-0,3	0,25-0,4
	Schnellarbeitsstahl	< 1300	80-100	80-100	0,1-0,2	0,1-0,25	0,2-0,3	0,25-0,4
	Werkzeugstahl für Kaltarbeit	< 1300	140-180	140-180	0,1-0,2	0,1-0,25	0,2-0,3	0,25-0,4
Werkzeugstahl für Warmarbeit	< 1300	140-180	140-180	0,1-0,2	0,1-0,25	0,2-0,3	0,25-0,4	
M	Stahl und Stahlguss, rostfrei geschwefelt	< 850	110-150	70-110	0,1-0,2	0,1-0,25	0,2-0,3	0,25-0,4
	Nichtrostender Stahl, ferritisch	< 750	110-150	70-110	0,1-0,2	0,1-0,25	0,2-0,3	0,25-0,4
	Nichtrostender Stahl, martensitisch	< 900	110-150	70-110	0,1-0,2	0,1-0,25	0,2-0,3	0,25-0,4
	Nichtrostender Stahl, ferritisch/martensitisch	< 1100	110-150	70-110	0,1-0,2	0,1-0,25	0,2-0,3	0,25-0,4
	Nichtrostender Stahl, austenitisch/ferritisch	< 850	110-150	70-110	0,1-0,2	0,1-0,25	0,2-0,3	0,25-0,4
	Nichtrostender Stahl, austenitisch	< 750	80-110	60-90	0,1-0,2	0,1-0,25	0,2-0,3	0,25-0,4
K	Hitzebeständig	< 1100	80-110	60-90	0,1-0,2	0,1-0,25	0,2-0,3	0,25-0,4
	Grauguss mit Lammellengraphit	100-350	300-350	250-300	0,1-0,2	0,1-0,3	0,2-0,3	0,3-0,5
	Grauguss mit Lammellengraphit	300-1000	180-250	180-250	0,1-0,2	0,1-0,3	0,2-0,3	0,3-0,5
	Kugelgraphitguss	300-500	200-250	150-200	0,1-0,2	0,1-0,25	0,2-0,3	0,25-0,4
	Kugelgraphitguss	550-800	200-250	150-200	0,1-0,2	0,1-0,25	0,2-0,3	0,25-0,4
	Temperguss, weiß	350-450	200-250	150-200	0,1-0,2	0,1-0,25	0,2-0,3	0,25-0,4
	Temperguss, weiß	500-650	200-250	150-200	0,1-0,2	0,1-0,25	0,2-0,3	0,25-0,4
	Temperguss, schwarz	350-450	200-250	150-200	0,1-0,2	0,1-0,25	0,2-0,3	0,25-0,4
Temperguss, schwarz	500-700	200-250	150-200	0,1-0,2	0,1-0,25	0,2-0,3	0,25-0,4	
N	Aluminium (unlegiert, niedrig legiert)	< 350	400-600	400-600	0,1-0,2	0,1-0,3	0,2-0,3	0,3-0,5
	Aluminiumlegierungen < 0,5% Si	< 500	400-600	400-600	0,1-0,2	0,1-0,3	0,2-0,3	0,3-0,5
	Aluminiumlegierungen 0,5 - 10% Si	< 400	400-600	400-600	0,1-0,2	0,1-0,3	0,2-0,3	0,3-0,5
	Aluminiumlegierungen 10 - 15% Si	< 400	400-600	400-600	0,1-0,2	0,1-0,3	0,2-0,3	0,3-0,5
	Aluminiumlegierungen > 15% Si	< 400	400-600	400-600	0,1-0,2	0,1-0,3	0,2-0,3	0,3-0,5
	Kupfer (unlegiert, niedrig legiert)	< 350	300-500	300-500	0,1-0,2	0,1-0,3	0,2-0,3	0,3-0,5
	Kupfer-Knetlegierungen	< 700	300-500	300-500	0,1-0,2	0,1-0,3	0,2-0,3	0,3-0,5
	Kupfer-Sonderlegierungen	< 200 HB	300-500	300-500	0,1-0,2	0,1-0,3	0,2-0,3	0,3-0,5
	Kupfer-Sonderlegierungen	< 300 HB	300-500	300-500	0,1-0,2	0,1-0,3	0,2-0,3	0,3-0,5
	Kupfer-Sonderlegierungen	> 300 HB	300-500	300-500	0,1-0,2	0,1-0,3	0,2-0,3	0,3-0,5
	Messing kurzspanend, Bronze, Rotguss	< 600	300-500	300-500	0,1-0,2	0,1-0,3	0,2-0,3	0,3-0,5
	Messing langspanend	< 600	300-500	300-500	0,1-0,2	0,1-0,3	0,2-0,3	0,3-0,5
	Thermoplaste							
	Duroplaste							
	Faserverstärkte Kunststoffe							
	Magnesium und Magnesiumlegierungen	< 850						
Graphit								
Wolfram und Wolframlegierungen								
Molybdän und Molybdänlegierungen								
S	Reinnickel							
	Nickellegierungen							
	Nickellegierungen	< 850						
	Nickel-Chromlegierungen		50-80	30-50	0,1-0,2	0,1-0,3	0,2-0,3	0,3-0,5
	Nickel- und Kobaltlegierungen	< 1300						
	Hochwärmefeste Legierungen	< 1300						
	Nickel-Kobalt-(Chrom-)legierungen	< 1400	50-80	30-50	0,1-0,2	0,1-0,3	0,2-0,3	0,3-0,5
	Nickel- und Kobaltlegierungen	< 1300						
	Reintitan	< 900						
Titanlegierungen	< 700	60-80	60-80	0,1-0,2	0,1-0,3	0,2-0,3	0,3-0,5	
Titanlegierungen	< 1200	40-80	40-80	0,1-0,2	0,1-0,3	0,2-0,3	0,3-0,5	
H	Stahl gehärtet	< 45 HRC	160-190	160-190	0,1-0,2	0,1-0,3	0,2-0,3	0,3-0,5
		46-55 HRC	150-180	80-120	0,1-0,2	0,1-0,25	0,2-0,3	0,25-0,4
		56-60 HRC	120-150	80-100	0,1-0,2	0,1-0,25	0,2-0,3	0,2-0,3
		61-65 HRC	80-110	60-90	0,1-0,2	0,1-0,25	0,2-0,3	0,2-0,3
	65-70 HRC							

Die Tabellenwerte sind Richtwerte. Es kann notwendig sein, die Werte den jeweiligen Bearbeitungsbedingungen anzupassen.



Approximate values Feed per tooth  $f_z$  [mm]

ISO	Material	Strength [N/mm <sup>2</sup> ]	Medium machining $V_c$ [m/min]	Rough machining $V_c$ [m/min]	Medium $d_1 = 2$ mm		Roughing $d_1 = 2$ mm	
					$a_D$ [mm]	$f_z$ [mm]	$a_D$ [mm]	$f_z$ [mm]
<b>P</b>	General construction steel	< 800	250-300	150-250	0,05-0,2	0,1-0,2	0,2-0,3	0,2-0,3
	Free cutting steel	< 800	250-300	150-250	0,05-0,2	0,1-0,2	0,2-0,3	0,2-0,3
	Case hardened steel, non alloyed	< 800	250-300	150-250	0,05-0,2	0,1-0,2	0,2-0,3	0,2-0,3
	Alloyed case hardened steel	< 1000	200-250	180-200	0,05-0,2	0,1-0,2	0,2-0,3	0,2-0,3
	Tempering steel, non alloyed	< 850	220-250	200-220	0,05-0,2	0,1-0,2	0,2-0,3	0,2-0,3
	Tempering steel, non alloyed	< 1000	220-250	200-220	0,05-0,2	0,1-0,2	0,2-0,3	0,2-0,3
	Tempering steel, alloyed	< 800	170-190	170-190	0,05-0,2	0,1-0,2	0,2-0,3	0,2-0,3
	Tempering steel, alloyed	< 1300	160-180	160-180	0,05-0,2	0,1-0,2	0,2-0,3	0,2-0,3
	Steel castings	< 850	220-250	200-220	0,05-0,2	0,1-0,2	0,2-0,3	0,2-0,3
	Nitriding steel	< 1000	170-190	170-190	0,05-0,2	0,1-0,2	0,2-0,3	0,2-0,3
	Nitriding steel	< 1200	160-180	160-180	0,05-0,2	0,1-0,2	0,2-0,3	0,2-0,3
	Roller bearing steel	< 1200	170-190	170-190	0,05-0,2	0,1-0,2	0,2-0,3	0,2-0,3
	Spring steel	< 1200	100-120	100-120	0,05-0,2	0,1-0,2	0,2-0,3	0,2-0,3
	High-speed steel	< 1300	80-100	80-100	0,05-0,2	0,1-0,2	0,2-0,3	0,2-0,3
	Cold working tool steel	< 1300	140-180	140-180	0,05-0,2	0,1-0,2	0,2-0,3	0,2-0,3
Hot working tool steel	< 1300	140-180	140-180	0,05-0,2	0,1-0,2	0,2-0,3	0,2-0,3	
<b>M</b>	Steel and sulphured cast stainless steel	< 850	110-150	70-110	0,05-0,2	0,1-0,2	0,2-0,3	0,2-0,3
	Stainless steel, ferritic	< 750	110-150	70-110	0,05-0,2	0,1-0,2	0,2-0,3	0,2-0,3
	Stainless steel, martensitic	< 900	110-150	70-110	0,05-0,2	0,1-0,2	0,2-0,3	0,2-0,3
	Stainless steel, ferritic / martensitic	< 1100	110-150	70-110	0,05-0,2	0,1-0,2	0,2-0,3	0,2-0,3
	Stainless steel, austenitic / ferritic	< 850	110-150	70-110	0,05-0,2	0,1-0,2	0,2-0,3	0,2-0,3
	Stainless steel, austenitic	< 750	80-110	60-90	0,05-0,2	0,1-0,2	0,2-0,3	0,2-0,3
	Heat resistant steel	< 1100	80-110	60-90	0,05-0,2	0,1-0,2	0,2-0,3	0,2-0,3
<b>K</b>	Grey cast iron with lamellar graphite	100-350	300-350	250-300	0,05-0,2	0,1-0,2	0,2-0,3	0,2-0,3
	Grey cast iron with lamellar graphite	300-1000	180-250	180-250	0,05-0,2	0,1-0,2	0,2-0,3	0,2-0,3
	Spheroidal cast iron	300-500	200-250	150-200	0,05-0,2	0,1-0,2	0,2-0,3	0,2-0,3
	Spheroidal cast iron	550-800	200-250	150-200	0,05-0,2	0,1-0,2	0,2-0,3	0,2-0,3
	White cast iron, tempered	350-450	200-250	150-200	0,05-0,2	0,1-0,2	0,2-0,3	0,2-0,3
	White cast iron, tempered	500-650	200-250	150-200	0,05-0,2	0,1-0,2	0,2-0,3	0,2-0,3
	Black cast iron, tempered	350-450	200-250	150-200	0,05-0,2	0,1-0,2	0,2-0,3	0,2-0,3
	Black cast iron, tempered	500-700	200-250	150-200	0,05-0,2	0,1-0,2	0,2-0,3	0,2-0,3
<b>N</b>	Aluminium (non alloyed, low alloyed)	< 350	400-600	400-600	0,05-0,2	0,1-0,2	0,2-0,3	0,2-0,3
	Aluminium alloys < 0,5% Si	< 500	400-600	400-600	0,05-0,2	0,1-0,2	0,2-0,3	0,2-0,3
	Aluminium alloys 0,5% - 10% Si	< 400	400-600	400-600	0,05-0,2	0,1-0,2	0,2-0,3	0,2-0,3
	Aluminium alloys 10% - 15% Si	< 400	400-600	400-600	0,05-0,2	0,1-0,2	0,2-0,3	0,2-0,3
	Aluminium alloys > 15% Si	< 400	400-600	400-600	0,05-0,2	0,1-0,2	0,2-0,3	0,2-0,3
	Copper (non alloyed, low alloyed)	< 350	300-500	300-500	0,05-0,2	0,1-0,2	0,2-0,3	0,2-0,3
	Copper wrought alloys	< 700	300-500	300-500	0,05-0,2	0,1-0,2	0,2-0,3	0,2-0,3
	Special copper alloys	< 200 HB	300-500	300-500	0,05-0,2	0,1-0,2	0,2-0,3	0,2-0,3
	Special copper alloys	< 300 HB	300-500	300-500	0,05-0,2	0,1-0,2	0,2-0,3	0,2-0,3
	Special copper alloys	> 300 HB	300-500	300-500	0,05-0,2	0,1-0,2	0,2-0,3	0,2-0,3
	Short-chipping brass, bronze, red bronze	< 600	300-500	300-500	0,05-0,2	0,1-0,2	0,2-0,3	0,2-0,3
	Long-chipping brass	< 600	300-500	300-500	0,05-0,2	0,1-0,2	0,2-0,3	0,2-0,3
	Thermoplastics							
	Duroplastics							
	Fibre-reinforced plastics							
	Magnesium and magnesium alloys	< 850						
	Graphite							
Tungsten and tungsten alloys								
Molybdenum and molybdenum alloys								
<b>S</b>	Pure nickel							
	Nickel alloys							
	Nickel alloys	< 850						
	Nickel-chromium alloys		50-80	30-50	0,05-0,2	0,1-0,2	0,2-0,3	0,2-0,3
	Nickel and cobalt alloys	< 1300						
	Nickel and cobalt alloys	< 1300						
	Heat resistant alloys	< 1400	50-80	30-50	0,05-0,2	0,1-0,2	0,2-0,3	0,2-0,3
	Nickel-cobalt-chromium alloys	< 1300						
	Pure titanium	< 900						
<b>H</b>	Titanium alloys	< 700	60-80	60-80				
	Titanium alloys	< 1200	40-80	40-80				
	Tempered steel	< 45 HRC	160-190	160-190	0,05-0,2	0,1-0,2	0,2-0,3	0,2-0,3
		46-55 HRC	150-180	80-120	0,05-0,2	0,1-0,2	0,2-0,3	0,2-0,3
		56-60 HRC	120-150	80-100	0,05-0,2	0,1-0,2	0,2-0,3	0,2-0,25
	61-65 HRC	80-110	60-90	0,05-0,2	0,1-0,2	0,2-0,3	0,2-0,25	
	65-70 HRC							

The recommended cutting data are only approximate values. It may be necessary to adjust them to each individual machining application.





Approximate values Feed per tooth  $f_z$  [mm]

ISO	Material	Strength [N/mm <sup>2</sup> ]	Medium machining $V_c$ [m/min]	Rough machining $V_c$ [m/min]	Medium $d_1 = 8$ mm		Roughing $d_1 = 8$ mm	
					$a_D$ [mm]	$f_z$ [mm]	$a_D$ [mm]	$f_z$ [mm]
P	General construction steel	< 800	250 - 300	150-250	0,1-0,2	0,1-0,3	0,2-0,3	0,3-0,5
	Free cutting steel	< 800	250-300	150-250	0,1-0,2	0,1-0,3	0,2-0,3	0,3-0,5
	Case hardened steel, non alloyed	< 800	250-300	150-250	0,1-0,2	0,1-0,3	0,2-0,3	0,3-0,5
	Alloyed case hardened steel	< 1000	200-250	180-200	0,1-0,2	0,1-0,25	0,2-0,3	0,25-0,4
	Tempering steel, non alloyed	< 850	220-250	200-220	0,1-0,2	0,1-0,25	0,2-0,3	0,25-0,4
	Tempering steel, non alloyed	< 1000	220-250	200-220	0,1-0,2	0,1-0,25	0,2-0,3	0,25-0,4
	Tempering steel, alloyed	< 800	170-190	170-190	0,1-0,2	0,1-0,25	0,2-0,3	0,25-0,4
	Tempering steel, alloyed	< 1300	160-180	160-180	0,1-0,2	0,1-0,25	0,2-0,3	0,25-0,4
	Steel castings	< 850	220-250	200-220	0,1-0,2	0,1-0,25	0,2-0,3	0,25-0,4
	Nitriding steel	< 1000	170-190	170-190	0,1-0,2	0,1-0,25	0,2-0,3	0,25-0,4
	Nitriding steel	< 1200	160-180	160-180	0,1-0,2	0,1-0,25	0,2-0,3	0,25-0,4
	Roller bearing steel	< 1200	170-190	170-190	0,1-0,2	0,1-0,25	0,2-0,3	0,25-0,4
	Spring steel	< 1200	100-120	100-120	0,1-0,2	0,1-0,25	0,2-0,3	0,25-0,4
	High-speed steel	< 1300	80-100	80-100	0,1-0,2	0,1-0,25	0,2-0,3	0,25-0,4
	Cold working tool steel	< 1300	140-180	140-180	0,1-0,2	0,1-0,25	0,2-0,3	0,25-0,4
Hot working tool steel	< 1300	140-180	140-180	0,1-0,2	0,1-0,25	0,2-0,3	0,25-0,4	
M	Steel and sulphured cast stainless steel	< 850	110-150	70-110	0,1-0,2	0,1-0,25	0,2-0,3	0,25-0,4
	Stainless steel, ferritic	< 750	110-150	70-110	0,1-0,2	0,1-0,25	0,2-0,3	0,25-0,4
	Stainless steel, martensitic	< 900	110-150	70-110	0,1-0,2	0,1-0,25	0,2-0,3	0,25-0,4
	Stainless steel, ferritic/martensitic	< 1100	110-150	70-110	0,1-0,2	0,1-0,25	0,2-0,3	0,25-0,4
	Stainless steel, austenitic/ferritic	< 850	110-150	70-110	0,1-0,2	0,1-0,25	0,2-0,3	0,25-0,4
	Stainless steel, austenitic	< 750	80-110	60-90	0,1-0,2	0,1-0,25	0,2-0,3	0,25-0,4
	Heat resistant steel	< 1100	80-110	60-90	0,1-0,2	0,1-0,25	0,2-0,3	0,25-0,4
K	Grey cast iron with lamellar graphite	100-350	300-350	250-300	0,1-0,2	0,1-0,3	0,2-0,3	0,3-0,5
	Grey cast iron with lamellar graphite	300-1000	180-250	180-250	0,1-0,2	0,1-0,3	0,2-0,3	0,3-0,5
	Spheroidal cast iron	300-500	200-250	150-200	0,1-0,2	0,1-0,25	0,2-0,3	0,25-0,4
	Spheroidal cast iron	550-800	200-250	150-200	0,1-0,2	0,1-0,25	0,2-0,3	0,25-0,4
	White cast iron, tempered	350-450	200-250	150-200	0,1-0,2	0,1-0,25	0,2-0,3	0,25-0,4
	White cast iron, tempered	500-650	200-250	150-200	0,1-0,2	0,1-0,25	0,2-0,3	0,25-0,4
	Black cast iron, tempered	350-450	200-250	150-200	0,1-0,2	0,1-0,25	0,2-0,3	0,25-0,4
	Black cast iron, tempered	500-700	200-250	150-200	0,1-0,2	0,1-0,25	0,2-0,3	0,25-0,4
N	Aluminium (non alloyed, low alloyed)	< 350	400-600	400-600	0,1-0,2	0,1-0,3	0,2-0,3	0,3-0,5
	Aluminium alloys < 0,5% Si	< 500	400-600	400-600	0,1-0,2	0,1-0,3	0,2-0,3	0,3-0,5
	Aluminium alloys 0,5% - 10% Si	< 400	400-600	400-600	0,1-0,2	0,1-0,3	0,2-0,3	0,3-0,5
	Aluminium alloys 10% - 15% Si	< 400	400-600	400-600	0,1-0,2	0,1-0,3	0,2-0,3	0,3-0,5
	Aluminium alloys > 15% Si	< 400	400-600	400-600	0,1-0,2	0,1-0,3	0,2-0,3	0,3-0,5
	Copper (non alloyed, low alloyed)	< 350	300-500	300-500	0,1-0,2	0,1-0,3	0,2-0,3	0,3-0,5
	Copper wrought alloys	< 700	300-500	300-500	0,1-0,2	0,1-0,3	0,2-0,3	0,3-0,5
	Special copper alloys	< 200 HB	300-500	300-500	0,1-0,2	0,1-0,3	0,2-0,3	0,3-0,5
	Special copper alloys	< 300 HB	300-500	300-500	0,1-0,2	0,1-0,3	0,2-0,3	0,3-0,5
	Special copper alloys	> 300 HB	300-500	300-500	0,1-0,2	0,1-0,3	0,2-0,3	0,3-0,5
	Short-chipping brass, bronze, red bronze	< 600	300-500	300-500	0,1-0,2	0,1-0,3	0,2-0,3	0,3-0,5
	Long-chipping brass	< 600	300-500	300-500	0,1-0,2	0,1-0,3	0,2-0,3	0,3-0,5
	Thermoplastics							
	Duroplastics							
	Fibre-reinforced plastics							
Magnesium and magnesium alloys	< 850							
Graphite								
Tungsten and tungsten alloys								
Molybdenum and molybdenum alloys								
S	Pure nickel							
	Nickel alloys							
	Nickel alloys	< 850						
	Nickel-chromium alloys		50-80	30-50	0,1-0,2	0,1-0,3	0,2-0,3	0,3-0,5
	Nickel and cobalt alloys	< 1300						
	Nickel and cobalt alloys	< 1300						
	Heat resistant alloys	< 1400	50-80	30-50	0,1-0,2	0,1-0,3	0,2-0,3	0,3-0,5
	Nickel-cobalt-chromium alloys	< 1300						
	Pure titanium	< 900						
H	Titanium alloys	< 700	60-80	60-80	0,1-0,2	0,1-0,3	0,2-0,3	0,3-0,5
	Titanium alloys	< 1200	40-80	40-80	0,1-0,2	0,1-0,3	0,2-0,3	0,3-0,5
	Tempered steel	< 45 HRC	160-190	160-190	0,1-0,2	0,1-0,3	0,2-0,3	0,3-0,5
		46-55 HRC	150-180	80-120	0,1-0,2	0,1-0,25	0,2-0,3	0,25-0,4
		56-60 HRC	120-150	80-100	0,1-0,2	0,1-0,25	0,2-0,3	0,2-0,3
	61-65 HRC	80-110	60-90	0,1-0,2	0,1-0,25	0,2-0,3	0,2-0,3	
	65-70 HRC							

The recommended cutting data are only approximate values. It may be necessary to adjust them to each individual machining application.



# Valeurs de coupe recommandées fraise à queue en carbure monobloc torique / fraise à haute avance

AFH

Valeurs indicatives pour l'avance par dent  $f_z$  [mm]

ISO	Matériau	Résistance [N/mm <sup>2</sup> ]	Usinage moyen $V_c$ [m/min]	Usinage d'ébauche $V_c$ [m/min]	Moyen $d_1 = 2$ mm		Ébauche $d_1 = 2$ mm	
					$a_D$ [mm]	$f_z$ [mm]	$a_D$ [mm]	$f_z$ [mm]
P	Acier de construction en général	< 800	250-300	150-250	0,05-0,2	0,1-0,2	0,2-0,3	0,2-0,3
	Acier de décolletage	< 800	250-300	150-250	0,05-0,2	0,1-0,2	0,2-0,3	0,2-0,3
	Acier cimenté, non allié	< 800	250-300	150-250	0,05-0,2	0,1-0,2	0,2-0,3	0,2-0,3
	Acier cimenté, allié	< 1000	200-250	180-200	0,05-0,2	0,1-0,2	0,2-0,3	0,2-0,3
	Acier de traitement, non allié	< 850	220-250	200-220	0,05-0,2	0,1-0,2	0,2-0,3	0,2-0,3
	Acier de traitement, non allié	< 1000	220-250	200-220	0,05-0,2	0,1-0,2	0,2-0,3	0,2-0,3
	Acier de traitement, allié	< 800	170-190	170-190	0,05-0,2	0,1-0,2	0,2-0,3	0,2-0,3
	Acier de traitement, allié	< 1300	160-180	160-180	0,05-0,2	0,1-0,2	0,2-0,3	0,2-0,3
	Acier coulé	< 850	220-250	200-220	0,05-0,2	0,1-0,2	0,2-0,3	0,2-0,3
	Acier de nitruration	< 1000	170-190	170-190	0,05-0,2	0,1-0,2	0,2-0,3	0,2-0,3
	Acier de nitruration	< 1200	160-180	160-180	0,05-0,2	0,1-0,2	0,2-0,3	0,2-0,3
	Acier à roulement	< 1200	170-190	170-190	0,05-0,2	0,1-0,2	0,2-0,3	0,2-0,3
	Acier à ressort	< 1200	100-120	100-120	0,05-0,2	0,1-0,2	0,2-0,3	0,2-0,3
	Acier rapide	< 1300	80-100	80-100	0,05-0,2	0,1-0,2	0,2-0,3	0,2-0,3
Acier à outils pour le travail à froid	< 1300	140-180	140-180	0,05-0,2	0,1-0,2	0,2-0,3	0,2-0,3	
Acier à outils pour le travail à chaud	< 1300	140-180	140-180	0,05-0,2	0,1-0,2	0,2-0,3	0,2-0,3	
M	Acier et acier coulé, inoxydable, sulfuré	< 850	110-150	70-110	0,05-0,2	0,1-0,2	0,2-0,3	0,2-0,3
	Acier inoxydable, ferritique	< 750	110-150	70-110	0,05-0,2	0,1-0,2	0,2-0,3	0,2-0,3
	Acier inoxydable, martensitique	< 900	110-150	70-110	0,05-0,2	0,1-0,2	0,2-0,3	0,2-0,3
	Acier inoxydable, ferritique/martensitique	< 1100	110-150	70-110	0,05-0,2	0,1-0,2	0,2-0,3	0,2-0,3
	Acier inoxydable, austénitique/ferritique	< 850	110-150	70-110	0,05-0,2	0,1-0,2	0,2-0,3	0,2-0,3
	Acier inoxydable, austénitique	< 750	80-110	60-90	0,05-0,2	0,1-0,2	0,2-0,3	0,2-0,3
	Matériau résistant à la chaleur	< 1100	80-110	60-90	0,05-0,2	0,1-0,2	0,2-0,3	0,2-0,3
K	Fonte grise à graphite lamellaire	100-350	300-350	250-300	0,05-0,2	0,1-0,2	0,2-0,3	0,2-0,3
	Fonte grise à graphite lamellaire	300-1000	180-250	180-250	0,05-0,2	0,1-0,2	0,2-0,3	0,2-0,3
	Fonte à graphite sphéroïdal	300-500	200-250	150-200	0,05-0,2	0,1-0,2	0,2-0,3	0,2-0,3
	Fonte à graphite sphéroïdal	550-800	200-250	150-200	0,05-0,2	0,1-0,2	0,2-0,3	0,2-0,3
	Fonte malléable, blanche	350-450	200-250	150-200	0,05-0,2	0,1-0,2	0,2-0,3	0,2-0,3
	Fonte malléable, blanche	500-650	200-250	150-200	0,05-0,2	0,1-0,2	0,2-0,3	0,2-0,3
	Fonte malléable, noire	350-450	200-250	150-200	0,05-0,2	0,1-0,2	0,2-0,3	0,2-0,3
	Fonte malléable, noire	500-700	200-250	150-200	0,05-0,2	0,1-0,2	0,2-0,3	0,2-0,3
N	Aluminium (non allié, faiblement allié)	< 350	400-600	400-600	0,05-0,2	0,1-0,2	0,2-0,3	0,2-0,3
	Alliages d'aluminium < 0,5 % Si	< 500	400-600	400-600	0,05-0,2	0,1-0,2	0,2-0,3	0,2-0,3
	Alliages d'aluminium 0,5 – 10 % Si	< 400	400-600	400-600	0,05-0,2	0,1-0,2	0,2-0,3	0,2-0,3
	Alliages d'aluminium 10 – 15 % Si	< 400	400-600	400-600	0,05-0,2	0,1-0,2	0,2-0,3	0,2-0,3
	Alliages d'aluminium > 15 % Si	< 400	400-600	400-600	0,05-0,2	0,1-0,2	0,2-0,3	0,2-0,3
	Cuivre (non allié, faiblement allié)	< 350	300-500	300-500	0,05-0,2	0,1-0,2	0,2-0,3	0,2-0,3
	Alliages de cuivre corroyés	< 700	300-500	300-500	0,05-0,2	0,1-0,2	0,2-0,3	0,2-0,3
	Alliages de cuivre et alliages spéciaux	< 200 HB	300-500	300-500	0,05-0,2	0,1-0,2	0,2-0,3	0,2-0,3
	Alliages de cuivre et alliages spéciaux	< 300 HB	300-500	300-500	0,05-0,2	0,1-0,2	0,2-0,3	0,2-0,3
	Alliages de cuivre et alliages spéciaux	> 300 HB	300-500	300-500	0,05-0,2	0,1-0,2	0,2-0,3	0,2-0,3
	Laiton à copeaux courts, bronze, fonte rouge	< 600	300-500	300-500	0,05-0,2	0,1-0,2	0,2-0,3	0,2-0,3
	Laiton à copeaux longs	< 600	300-500	300-500	0,05-0,2	0,1-0,2	0,2-0,3	0,2-0,3
	Thermoplastiques							
	Matériaux thermodurcissables							
	Matières plastiques renforcées							
Magnésium et alliages de magnésium	< 850							
Graphite								
Tungstène et alliages de tungstène								
Molybdène et alliages de molybdène								
S	Nickel pur							
	Alliages de nickel							
	Alliages de nickel	< 850						
	Alliages de nickel et de chrome		50-80	30-50	0,05-0,2	0,1-0,2	0,2-0,3	0,2-0,3
	Alliages de nickel et de cobalt	< 1300						
	Alliages réfractaires	< 1300						
	Alliages nickel-cobalt (chrome)	< 1400	50-80	30-50	0,05-0,2	0,1-0,2	0,2-0,3	0,2-0,3
	Alliages de nickel et de cobalt	< 1300						
	Titane pur	< 900						
	Alliages de titane	< 700	60-80	60-80				
Alliages de titane	< 1200	40-80	40-80					
H	Acier trempé	< 45 HRC	160-190	160-190	0,05-0,2	0,1-0,2	0,2-0,3	0,2-0,3
		46 – 55 HRC	150-180	80-120	0,05-0,2	0,1-0,2	0,2-0,3	0,2-0,3
		56 – 60 HRC	120-150	80-100	0,05-0,2	0,1-0,2	0,2-0,3	0,2-0,25
		61 – 65 HRC	80-110	60-90	0,05-0,2	0,1-0,2	0,2-0,3	0,2-0,25
		65 – 70 HRC						

Les valeurs du tableau sont indicatives. Il peut être nécessaire de les adapter aux conditions d'usinage respectives.



Valeurs indicatives pour l'avance par dent  $f_z$  [mm]

ISO	Matériau	Résistance [N/mm <sup>2</sup> ]	Usinage moyen $V_c$ [m/min]	Usinage d'ébauche $V_c$ [m/min]	Moyen $d_1 = 8$ mm		Ébauche $d_1 = 8$ mm	
					$a_D$ [mm]	$f_z$ [mm]	$a_D$ [mm]	$f_z$ [mm]
P	Acier de construction en général	< 800	250-300	150-250	0,1-0,2	0,1-0,3	0,2-0,3	0,3-0,5
	Acier de décolletage	< 800	250-300	150-250	0,1-0,2	0,1-0,3	0,2-0,3	0,3-0,5
	Acier cémenté, non allié	< 800	250-300	150-250	0,1-0,2	0,1-0,3	0,2-0,3	0,3-0,5
	Acier cémenté, allié	< 1000	200-250	180-200	0,1-0,2	0,1-0,25	0,2-0,3	0,25-0,4
	Acier de traitement, non allié	< 850	220-250	200-220	0,1-0,2	0,1-0,25	0,2-0,3	0,25-0,4
	Acier de traitement, non allié	< 1000	220-250	200-220	0,1-0,2	0,1-0,25	0,2-0,3	0,25-0,4
	Acier de traitement, allié	< 800	170-190	170-190	0,1-0,2	0,1-0,25	0,2-0,3	0,25-0,4
	Acier de traitement, allié	< 1300	160-180	160-180	0,1-0,2	0,1-0,25	0,2-0,3	0,25-0,4
	Acier coulé	< 850	220-250	200-220	0,1-0,2	0,1-0,25	0,2-0,3	0,25-0,4
	Acier de nitruration	< 1000	170-190	170-190	0,1-0,2	0,1-0,25	0,2-0,3	0,25-0,4
	Acier de nitruration	< 1200	160-180	160-180	0,1-0,2	0,1-0,25	0,2-0,3	0,25-0,4
	Acier à roulement	< 1200	170-190	170-190	0,1-0,2	0,1-0,25	0,2-0,3	0,25-0,4
	Acier à ressort	< 1200	100-120	100-120	0,1-0,2	0,1-0,25	0,2-0,3	0,25-0,4
	Acier rapide	< 1300	80-100	80-100	0,1-0,2	0,1-0,25	0,2-0,3	0,25-0,4
	Acier à outils pour le travail à froid	< 1300	140-180	140-180	0,1-0,2	0,1-0,25	0,2-0,3	0,25-0,4
Acier à outils pour le travail à chaud	< 1300	140-180	140-180	0,1-0,2	0,1-0,25	0,2-0,3	0,25-0,4	
M	Acier et acier coulé, inoxydable, sulfuré	< 850	110-150	70-110	0,1-0,2	0,1-0,25	0,2-0,3	0,25-0,4
	Acier inoxydable, ferritique	< 750	110-150	70-110	0,1-0,2	0,1-0,25	0,2-0,3	0,25-0,4
	Acier inoxydable, martensitique	< 900	110-150	70-110	0,1-0,2	0,1-0,25	0,2-0,3	0,25-0,4
	Acier inoxydable, ferritique/martensitique	< 1100	110-150	70-110	0,1-0,2	0,1-0,25	0,2-0,3	0,25-0,4
	Acier inoxydable, austénitique/ferritique	< 850	110-150	70-110	0,1-0,2	0,1-0,25	0,2-0,3	0,25-0,4
	Acier inoxydable, austénitique	< 750	80-110	60-90	0,1-0,2	0,1-0,25	0,2-0,3	0,25-0,4
	Matériau résistant à la chaleur	< 1100	80-110	60-90	0,1-0,2	0,1-0,25	0,2-0,3	0,25-0,4
K	Fonte grise à graphite lamellaire	100-350	300-350	250-300	0,1-0,2	0,1-0,3	0,2-0,3	0,3-0,5
	Fonte grise à graphite lamellaire	300-1000	180-250	180-250	0,1-0,2	0,1-0,3	0,2-0,3	0,3-0,5
	Fonte à graphite sphéroïdal	300-500	200-250	150-200	0,1-0,2	0,1-0,25	0,2-0,3	0,25-0,4
	Fonte à graphite sphéroïdal	550-800	200-250	150-200	0,1-0,2	0,1-0,25	0,2-0,3	0,25-0,4
	Fonte malléable, blanche	350-450	200-250	150-200	0,1-0,2	0,1-0,25	0,2-0,3	0,25-0,4
	Fonte malléable, blanche	500-650	200-250	150-200	0,1-0,2	0,1-0,25	0,2-0,3	0,25-0,4
	Fonte malléable, noire	350-450	200-250	150-200	0,1-0,2	0,1-0,25	0,2-0,3	0,25-0,4
	Fonte malléable, noire	500-700	200-250	150-200	0,1-0,2	0,1-0,25	0,2-0,3	0,25-0,4
N	Aluminium (non allié, faiblement allié)	< 350	400-600	400-600	0,1-0,2	0,1-0,3	0,2-0,3	0,3-0,5
	Alliages d'aluminium < 0,5 % Si	< 500	400-600	400-600	0,1-0,2	0,1-0,3	0,2-0,3	0,3-0,5
	Alliages d'aluminium 0,5 – 10 % Si	< 400	400-600	400-600	0,1-0,2	0,1-0,3	0,2-0,3	0,3-0,5
	Alliages d'aluminium 10 – 15 % Si	< 400	400-600	400-600	0,1-0,2	0,1-0,3	0,2-0,3	0,3-0,5
	Alliages d'aluminium > 15 % Si	< 400	400-600	400-600	0,1-0,2	0,1-0,3	0,2-0,3	0,3-0,5
	Cuivre (non allié, faiblement allié)	< 350	300-500	300-500	0,1-0,2	0,1-0,3	0,2-0,3	0,3-0,5
	Alliages de cuivre corroyés	< 700	300-500	300-500	0,1-0,2	0,1-0,3	0,2-0,3	0,3-0,5
	Alliages de cuivre et alliages spéciaux	< 200 HB	300-500	300-500	0,1-0,2	0,1-0,3	0,2-0,3	0,3-0,5
	Alliages de cuivre et alliages spéciaux	< 300 HB	300-500	300-500	0,1-0,2	0,1-0,3	0,2-0,3	0,3-0,5
	Alliages de cuivre et alliages spéciaux	> 300 HB	300-500	300-500	0,1-0,2	0,1-0,3	0,2-0,3	0,3-0,5
	Laiton à copeaux courts, bronze, fonte rouge	< 600	300-500	300-500	0,1-0,2	0,1-0,3	0,2-0,3	0,3-0,5
	Laiton à copeaux longs	< 600	300-500	300-500	0,1-0,2	0,1-0,3	0,2-0,3	0,3-0,5
	Thermoplastiques							
	Matériaux thermodurcissables							
	Matières plastiques renforcées							
Magnésium et alliages de magnésium	< 850							
Graphite								
Tungstène et alliages de tungstène								
Molybdène et alliages de molybdène								
S	Nickel pur							
	Alliages de nickel							
	Alliages de nickel	< 850						
	Alliages de nickel et de chrome		50-80	30-50	0,1-0,2	0,1-0,3	0,2-0,3	0,3-0,5
	Alliages de nickel et de cobalt	< 1300						
	Alliages réfractaires	< 1300						
	Alliages nickel-cobalt (chrome)	< 1400	50-80	30-50	0,1-0,2	0,1-0,3	0,2-0,3	0,3-0,5
	Alliages de nickel et de cobalt	< 1300						
	Titane pur	< 900						
	Alliages de titane	< 700	60-80	60-80	0,1-0,2	0,1-0,3	0,2-0,3	0,3-0,5
Alliages de titane	< 1200	40-80	40-80	0,1-0,2	0,1-0,3	0,2-0,3	0,3-0,5	
H	Acier trempé	< 45 HRC	160-190	160-190	0,1-0,2	0,1-0,3	0,2-0,3	0,3-0,5
		46 – 55 HRC	150-180	80-120	0,1-0,2	0,1-0,25	0,2-0,3	0,25-0,4
		56 – 60 HRC	120-150	80-100	0,1-0,2	0,1-0,25	0,2-0,3	0,2-0,3
		61 – 65 HRC	80-110	60-90	0,1-0,2	0,1-0,25	0,2-0,3	0,2-0,3
		65 – 70 HRC						

Les valeurs du tableau sont indicatives. Il peut être nécessaire de les adapter aux conditions d'usinage respectives.



## Weitere Highlights unserer Frässysteme.

*Other highlights from our milling range.*

*Autres points forts de notre gamme de fraisage.*



### **ARNO®-Frässystem DUO-MILL**

**Eckfräsen und HFC-Fräsen mit nur einem Werkzeug.**

*ARNO® milling-system DUO-MILL*

*Square shoulder and high feed (HFC) milling with just one tool.*

Système de fraisage ARNO® DUO-MILL

Fraisage à 90° et grande avance avec un seul outil



### **ARNO®-Frässystem FTA**

**Der universelle Planfräser zur Kostenreduzierung.**

*ARNO® milling-system FTA*

*Face milling tool for cost reduction.*

Système de fraisage ARNO® FTA

Le surfacage rentable !



### **ARNO®-Frässystem FOA**

**Der positiv weichschneidende Planfräser, der eine Rundplatte und eine oktagonale Wendschneidplatte in einem Plattensitz vereint.**

*ARNO® milling-system FOA*

*The positive face-milling-cutter, in which both a round and an octogonal insert can be used.*

Système de fraisage ARNO® FOA

La fraise polyvalente qui peut recevoir des plaquettes octogonales ou rondes, angle d'attaque positif pour une coupe douce et des efforts de coupe réduits au minimum.

**Weitere Informationen finden Sie unter**

*For more information see*

*Pour plus d'informations*

**ARNO®**  
**WERKZEUGE**

**www.arno.de**



# ARNO<sup>®</sup>

## WERKZEUGE

We have a passion for precision.

# AUSFÜHRUNG AFJ

*Design AFJ / Modèle AFJ*

**Ideal für Exoten und rostfreie Stähle.**

*Ideal for exotics and stainless steel.*

*Idéal pour les matériaux exotiques et les aciers inoxydables.*

**Spezielle Fräser zur Bearbeitung rostfreier Stähle und exotischer Materialien wie Titan, Inconel<sup>®</sup> oder Hastelloy<sup>®</sup> – auch für die HSC-Bearbeitung geeignet.**



*Especially developed for milling stainless steel and exotic materials such as titanium, Inconel<sup>®</sup> and Hastelloy<sup>®</sup>. Also suitable for high speed milling.*

Fraises spéciales pour l'usinage des aciers inoxydables et des matériaux exotiques comme le titane, Inconel<sup>®</sup> ou Hastelloy<sup>®</sup>. Convient également à l'usinage à grande vitesse.

Solid carbide end-mill

Fraise carbure monobloc à tige

## AFJ612.1-...

3 - 4 Schneiden, lange Ausführung / 3 - 4 flutes, long design / 3 - 4 dents, version longue

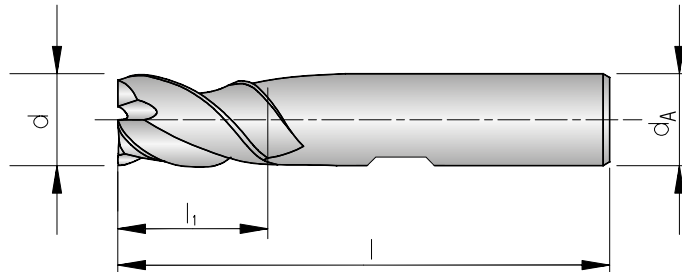
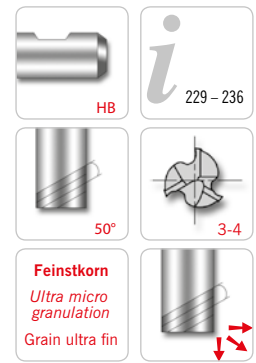

PG 24

beschichtet  
coated  
revêtu

Schaft DIN 6535HB

Shank  
Tige

	d -0,03	d <sub>A</sub> h6	l <sub>1</sub>	l	z	TiAIN
AFJ61231-030A	3	6	8	52	3	●
AFJ61231-040A	4	6	11	55	3	●
AFJ61231-050A	5	6	13	57	3	●
AFJ61231-060	6	6	13	50	3	●
AFJ61231-060A	6	6	13	57	3	●
AFJ61231-080	8	8	19	60	3	●
AFJ61231-080A	8	8	19	63	3	●
AFJ61231-100	10	10	22	70	3	●
AFJ61231-100A	10	10	22	72	3	●
AFJ61231-120	12	12	25	75	3	●
AFJ61231-120A	12	12	25	83	3	●
AFJ61231-160	16	16	32	90	3	●
AFJ61231-160A	16	16	32	92	3	●
AFJ61241-200	20	20	38	100	4	●
AFJ61241-200A	20	20	38	104	4	●
AFJ61241-250	25	25	45	120	4	●
AFJ61241-250A	25	25	45	121	4	●

P	○
M	●
K	
N	
S	●
H	

● Hauptanwendung  
Main application  
Application principale

○ Nebenanwendung  
Secondary application  
Application secondaire

AFJ

Solid carbide end-mill

Fraise carbure monobloc à tige

## AFJ602.0-...

4 - 8 Schneiden, kurze Ausführung / 4 - 8 flutes, short design / 4 - 8 dents, version courte

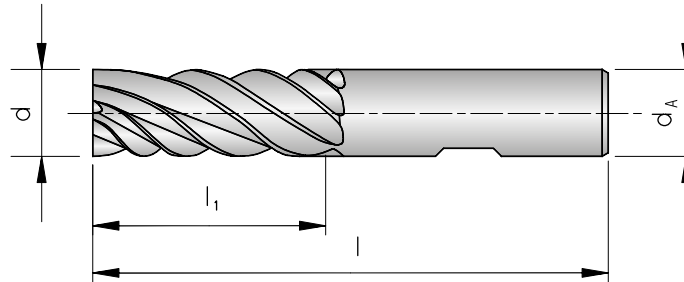
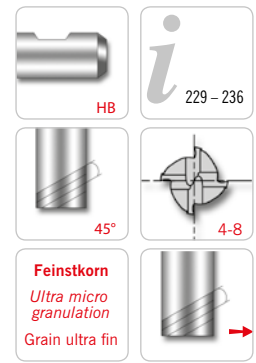

							PG 24
							beschichtet coated revêtu
Schaft DIN 6535HB Shank Tige	d -0,03	d <sub>A</sub> h6	l <sub>1</sub>	l	z	TiN	
AFJ60240-030	3	6	8	52	4	●	
AFJ60240-040	4	6	11	55	4	●	
AFJ60240-050	5	6	13	57	4	●	
AFJ60260-060	6	6	13	57	6	●	
AFJ60260-080	8	8	19	63	6	●	
AFJ60260-100	10	10	22	72	6	●	
AFJ60260-120	12	12	26	83	6	●	
AFJ60260-140	14	14	26	83	6	●	
AFJ60260-160	16	16	32	92	6	●	
AFJ60280-200	20	20	38	104	8	●	

P	○
M	●
K	
N	
S	●
H	

● Hauptanwendung  
Main application  
Application principale

○ Nebenanwendung  
Secondary application  
Application secondaire

Solid carbide roughing end-mill  
Fraise carbure monobloc d'ébauche

## AFJ619.1-...

3 - 6 Schneiden, lange Ausführung / 3 - 6 flutes, long design / 3 - 6 dents, version longue

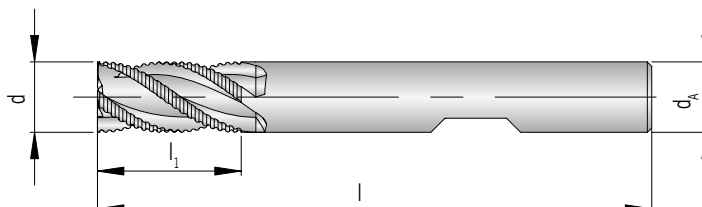

PG 24

beschichtet  
coated  
revêtu

Schaft DIN 6535HB

Shank  
Tige

	d h10	d <sub>A</sub> h6	l <sub>1</sub>	l	z	TiAIN
AFJ61931-040	4	6	11	57	3	●
AFJ61941-050	5	6	13	57	4	●
AFJ61941-060	6	6	16	57	4	●
AFJ61941-080	8	8	16	63	4	●
AFJ61941-100	10	10	22	72	4	●
AFJ61941-120	12	12	26	83	4	●
AFJ61941-140	14	14	26	83	4	●
AFJ61951-160	16	16	32	92	5	●
AFJ61961-200	20	20	38	104	6	●
AFJ61961-250	25	25	45	121	6	●

P	○
M	●
K	
N	
S	●
H	

● Hauptanwendung  
Main application  
Application principale  
○ Nebenanwendung  
Secondary application  
Application secondaire

Werkstoff- gruppe	Gliederung der Werkstoffhauptgruppen und Kennbuchstaben		Brinell-Härte	Zugfestigkeit Rm (N/mm <sup>2</sup> )	Zerspanungsgruppe	Korrekturfaktor	Schnittgeschwindigkeit V <sub>c</sub> (m/min)	
							VHM	TiAlN
<b>P</b>	Unlegierter Stahl	C ≤ 0,25 % geglüht	125	428	P1		-	-
		C > 0,25 ... ≤ 0,55 % geglüht	190	639	P2		-	-
		C > 0,25 ... ≤ 0,55 % vergütet	210	708	P3		-	-
		C > 0,55 % geglüht	190	639	P4		-	-
		C > 0,55 % vergütet	300	1013	P5		-	-
		Automatenstahl (kurzspanend) geglüht	220	745	P6		-	-
	Niedrig legierter Stahl	geglüht	175	591	P7		-	-
		vergütet	300	1013	P8		-	-
		vergütet	380	1282	P9		-	-
		vergütet	430	1477	P10		-	-
	Hochlegierter Stahl und hochlegierter Werkzeugstahl	geglüht	200	675	P11		-	-
		gehärtet und angelassen	300	1013	P12		-	-
		gehärtet und angelassen	400	1361	P13		-	-
	Nichtrostender Stahl	ferritisch / martensitisch, geglüht	200	675	P14		-	-
		martensitisch, vergütet	330	1114	P15		-	-
<b>M</b>	Nichtrostender Stahl	austenitisch, abgeschreckt	200	675	M1	1,0	60 - 90 - 120	
		austenitisch, ausscheidungsgehärtet (PH)	300	1013	M2	0,9	30 - 55 - 80	
		austenitisch-ferritisch, Duplex	230	778	M3	1,0	50 - 85 - 120	
<b>K</b>	Temperguss	ferritisch	200	675	K1		-	-
		perritisch	260	867	K2		-	-
	Grauguss	niedrige Festigkeit	180	602	K3		-	-
		hohe Festigkeit / austenitisch	245	825	K4		-	-
	Gusseisen mit Kugelgraphit	ferritisch	155	518	K5		-	-
		perritisch	265	885	K6		-	-
	GGV (CGI)		200	675	K7		-	-
<b>N</b>	Aluminium-Knetlegierungen	nicht aushärtbar	30	-	N1		-	-
		aushärtbar, ausgehärtet	100	343	N2		-	-
	Aluminium-Gusslegierungen	≤ 12 % Si, nicht aushärtbar	75	260	N3		-	-
		≤ 12 % Si, aushärtbar, ausgehärtet	90	314	N4		-	-
		> 12 % Si, nicht aushärtbar	130	447	N5		-	-
	Magnesiumlegierungen		70	250	N6		-	-
	Kupfer und Kupferlegierungen (Bronze / Messing)	unlegiert, Elektrolytkupfer	100	343	N7		-	-
		Messing, Bronze, Rotguss	90	314	N8		-	-
		Cu-Legierung, kurzspanend	110	382	N9		-	-
		hochfest, Ampco	300	1013	N10		-	-
Nichtmetallische Werkstoffe	Thermoplaste (ohne abrasive Füllstoffe)	-	-	N11		-	-	
	Duroplaste (ohne abrasive Füllstoffe)	-	-	N12		-	-	
	Kunststoff glasfaserverstärkt GFRP	-	-	N13		-	-	
	Kunststoff kohlefaserverstärkt CFRP	-	-	N14		-	-	
	Kunststoff aramidfaserverstärkt AFRP	-	-	N15		-	-	
	Graphit (technisch)	80 Shore	-	N16		-	-	
<b>S</b>	Warmfeste Legierungen	Fe-Basis geglüht	200	675	S1	0,7	30 - 60 - 90	
		ausgehärtet	280	943	S2	0,7	30 - 60 - 90	
		geglüht	250	839	S3	0,9	30 - 50 - 70	
		Ni- oder Co-Basis ausgehärtet	350	1177	S4	0,7	30 - 55 - 80	
		gegossen	320	1076	S5	0,7	30 - 55 - 80	
	Titanlegierungen	Reintitan	200	675	S6	1,0	50 - 85 - 120	
		α- und β-Legierungen, ausgehärtet	375	1262	S7	1,0	40 - 75 - 110	
		β-Legierungen	410	1396	S8	1,0	40 - 75 - 110	
	Wolframlegierungen		300	1013	S9		-	-
	Molybdänlegierungen		300	1013	S10		-	-
<b>H</b>	Gehärteter Stahl	gehärtet und angelassen	50 HRC	-	H1		-	-
		gehärtet und angelassen	55 HRC	-	H2		-	-
		gehärtet und angelassen	60 HRC	-	H3		-	-
	Gehärtetes Gusseisen	gehärtet und angelassen	55 HRC	-	H4		-	-

Die Tabellenwerte sind Richtwerte. Es kann notwendig sein, die Werte den jeweiligen Bearbeitungsumständen anzupassen.

Material group	Structure of the material groups and identification letters		Brinell hardness HB	Tensile strength Rm (N/mm <sup>2</sup> )	Chipping group	Correction factor	Cutting speed V <sub>c</sub> (m/min)	
							VHM	TiAIN
P	Unalloyed steel	C ≤ 0.25 % annealed	125	428	P1		-	-
		C > 0.25 ... ≤ 0.55 % annealed	190	639	P2		-	-
		C > 0.25 ... ≤ 0.55 % hardened and tempered	210	708	P3		-	-
		C > 0.55 % annealed	190	639	P4		-	-
		C > 0.55 % hardened and tempered	300	1013	P5		-	-
		Machining steel (short-chipping) tempered	220	745	P6		-	-
	Low alloyed steel	annealed	175	591	P7		-	-
		hardened and tempered	300	1013	P8		-	-
		hardened and tempered	380	1282	P9		-	-
		hardened and tempered	430	1477	P10		-	-
	High alloyed steel and high alloyed tool steel	annealed	200	675	P11		-	-
		hardened	300	1013	P12		-	-
		hardened	400	1361	P13		-	-
	Stainless steel	ferritic / martensitic, annealed	200	675	P14		-	-
		martensitic, hardened and tempered	330	1114	P15		-	-
M	Stainless steel	austenitic, chilled	200	675	M1	1,0	60 - 90 - 120	-
		austenitic, precipitation-hardened (PH)	300	1013	M2	0,9	30 - 55 - 80	-
		austenitic-ferritic, Duplex	230	778	M3	1,0	50 - 85 - 120	-
K	Malleable cast iron	ferritic	200	675	K1		-	-
		pearlitic	260	867	K2		-	-
	Cast iron	low tensile strength	180	602	K3		-	-
		high tensile strength / austenitic	245	825	K4		-	-
	Cast iron with nodular graphite	ferritic	155	518	K5		-	-
		pearlitic	265	885	K6		-	-
	GGV (CGI)		200	675	K7		-	-
N	Aluminium alloys long chipping	not heat treatable	30	-	N1		-	-
		heat treatable, heat treated	100	343	N2		-	-
	Casted aluminium alloys	≤ 12 % Si, not heat treatable	75	260	N3		-	-
		≤ 12 % Si, aushärtbar, ausgehärtet	90	314	N4		-	-
		> 12 % Si, not heat treatable	130	447	N5		-	-
	Magnesium alloys		70	250	N6		-	-
	Copper and copper alloys (Brass / Bronze)	Unalloyed, elektrolyte copper	100	343	N7		-	-
		Brass, Bronze	90	314	N8		-	-
		Cu-alloys, short-chipping	110	382	N9		-	-
		High-tensile, Ampco	300	1013	N10		-	-
	Non-ferrous materials	Lead alloys (without abrasive filling material)	-	-	N11		-	-
		Duroplastic (without abrasive filling material)	-	-	N12		-	-
		Plastic glas fibre reinforced GFRP	-	-	N13		-	-
		Plastic carbon fibre reinforced CFRP	-	-	N14		-	-
		Plastic aramid fibre reinforced AFRP	-	-	N15		-	-
		Graphite (tech.)	80 Shore	-	N16		-	-
S	High temperature resistant alloys	Fe-Basis	annealed	200	675	S1	0,7	30 - 60 - 90
			heat treated	280	943	S2	0,7	30 - 60 - 90
		Ni- or Co-alloyed	annealed	250	839	S3	0,9	30 - 50 - 70
			heat treated	350	1177	S4	0,7	30 - 55 - 80
			casting	320	1076	S5	0,7	30 - 55 - 80
	Titanium alloys	Pure titan	200	675	S6	1,0	50 - 85 - 120	
		α- and β-alloys, heat treated	375	1262	S7	1,0	40 - 75 - 110	
	β-alloys	410	1396	S8	1,0	40 - 75 - 110		
	Wolfram alloys		300	1013	S9		-	
	Molybdän alloys		300	1013	S10		-	
H	Hardened steel	hardened	50 HRC	-	H1		-	
		hardened	55 HRC	-	H2		-	
		hardened	60 HRC	-	H3		-	
	Hardened cast iron	hardened	55 HRC	-	H4		-	

The recommended cutting data are only approximate values. It may be necessary to adjust them to each individual machining application.

ISO	Matériaux	Dureté Brinell	Résistance (N/mm <sup>2</sup> )	Groupe d'usinage	facteur de correction	Vitesse de coupe Vc (m/min)	
						VHM	TAIN
P	Acier non allié	C ≤ 0,25 % recuit	125	428	P1		-
		C > 0,25 ... ≤ 0,55 % recuit	190	639	P2		-
		C > 0,25 ... ≤ 0,55 % traité	210	708	P3		-
		C > 0,55 % recuit	190	639	P4		-
		C > 0,55 % traité	300	1013	P5		-
		Aciers de décolletage (à copeaux courts) recuit	220	745	P6		-
	Acier faiblement allié	recuit	175	591	P7		-
		traité	300	1013	P8		-
		traité	380	1282	P9		-
		traité	430	1477	P10		-
	Acier allié et acier outil allié	recuit	200	675	P11		-
		trempe et revenu	300	1013	P12		-
		trempe et revenu	400	1361	P13		-
	Acier inox	ferritique, martensitique, recuit	200	675	P14		-
		martensitique, traité	330	1114	P15		-
M	Acier inox	austénitique	200	675	M1	1,0	60 - 90 - 120
		austénitique	300	1013	M2	0,9	30 - 55 - 80
		austénitique-ferritique, Duplex	230	778	M3	1,0	50 - 85 - 120
K	Fonte malléable	ferritique	200	675	K1		-
		perlitique	260	867	K2		-
	Fonte grise	faible résistance	180	602	K3		-
		haute résistance / austénitique	245	825	K4		-
	Fonte à Graphite sphéroïdale	ferritique	155	518	K5		-
		perlitique	265	885	K6		-
	GGV (CGI)		200	675	K7		-
N	Alliages de fonderie d'aluminium	ne pouvant pas subir un durcissement	30	-	N1		-
		pouvant subir un durcissement, durci	100	343	N2		-
	Alliage de fonte d'aluminium	≤ 12 % Si, ne pouvant pas subir de durcissement	75	260	N3		-
		≤ 12 % Si, pouvant subir un durcissement, durci	90	314	N4		-
		> 12 % Si, ne pouvant pas subir de durcissement	130	447	N5		-
	Alliage de Magnésium		70	250	N6		-
	Cuivre et alliage de cuivre (bronze / laiton)	non allié, cuivre électrolytique	100	343	N7		-
		Laiton, bronze, fonte rouge	90	314	N8		-
		Alliage de cuivre à copeaux courts	110	382	N9		-
		forte résistance, Ampco	300	1013	N10		-
Matériaux non métalliques	Thermoplaste (sans agents de charge abrasives)	-	-	N11		-	
	Duroplaste (sans agents de charge abrasives)	-	-	N12		-	
	Matière plastique renforcée de fibres de verre GFRP	-	-	N13		-	
	Matière plastique renforcé composite CFRP	-	-	N14		-	
	Plastique renforcé fibre aramide AFRP	-	-	N15		-	
	Graphite	80 Shore	-	N16		-	
S	Alliages réfractaires	à base de Fe recuit	200	675	S1	0,7	30 - 60 - 90
		à base de Fe durci	280	943	S2	0,7	30 - 60 - 90
		à base de Fe recuit	250	839	S3	0,9	30 - 50 - 70
		à base Ni ou Co durci	350	1177	S4	0,7	30 - 55 - 80
		à base Ni ou Co jeter	320	1076	S5	0,7	30 - 55 - 80
	Alliage de titane	Titane pur	200	675	S6	1,0	50 - 85 - 120
		Alliages Alpha + Beta, trempé	375	1262	S7	1,0	40 - 75 - 110
		Alliages Beta	410	1396	S8	1,0	40 - 75 - 110
	Alliage de tungstène		300	1013	S9		-
	Alliage de molybdène		300	1013	S10		-
H	Acier trempé	trempe et revenu	50 HRC	-	H1		-
		trempe et revenu	55 HRC	-	H2		-
		trempe et revenu	60 HRC	-	H3		-
	Fonte durci	trempe et revenu	55 HRC	-	H4		-

Les valeurs du tableau sont indicatives. Il peut être nécessaire de les adapter aux conditions d'usinage respectives.

## Vorschub pro Zahn bei einer radialen Zustellung von 0,2 – 0,3 mm

Feed per tooth with radial depth of cut from 0,2 – 0,3 mm

Avance par dent avec un engagement radial de 0,2 – 0,3 mm

Ø d <sub>1</sub> [mm]	Korrekturfaktor / Correction factor / Facteur de correction									
	1	0,7	0,8	0,9	1,1	1,2	1,5	1,6	1,8	1,9
1	0,004	0,003	0,003	0,004	0,004	0,005	0,006	0,006	0,007	0,008
2	0,008	0,006	0,006	0,007	0,009	0,010	0,012	0,013	0,014	0,015
3	0,012	0,008	0,010	0,011	0,013	0,014	0,018	0,019	0,022	0,023
4	0,016	0,011	0,013	0,014	0,018	0,019	0,024	0,026	0,029	0,030
5	0,020	0,014	0,016	0,018	0,022	0,024	0,030	0,032	0,036	0,038
6	0,024	0,017	0,019	0,022	0,026	0,029	0,036	0,038	0,043	0,046
8	0,032	0,022	0,026	0,029	0,035	0,038	0,048	0,051	0,058	0,061
10	0,040	0,028	0,032	0,036	0,044	0,048	0,060	0,064	0,072	0,076
12	0,048	0,034	0,038	0,043	0,053	0,058	0,072	0,077	0,086	0,091
14	0,056	0,039	0,045	0,050	0,062	0,067	0,084	0,090	0,101	0,106
16	0,064	0,045	0,051	0,058	0,070	0,077	0,096	0,102	0,115	0,122
18	0,072	0,050	0,058	0,065	0,079	0,086	0,108	0,115	0,130	0,137
20	0,080	0,056	0,064	0,072	0,088	0,096	0,120	0,128	0,144	0,152
25	0,100	0,070	0,080	0,090	0,110	0,120	0,150	0,160	0,180	0,190

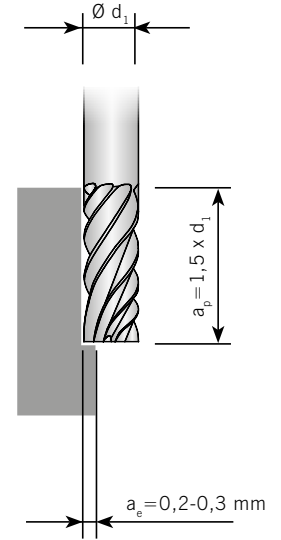

## Vorschub pro Zahn bei einer radialen Zustellung 10% vom Schneidendurchmesser (Ø d<sub>1</sub>)

Feed per tooth with radial depth of cut of 10% of the cutter (Ø d<sub>1</sub>)

Avance par dent avec un engagement radial de 10 % du diamètre de coupe (Ø d<sub>1</sub>)

Ø d <sub>1</sub> [mm]	Korrekturfaktor / Correction factor / Facteur de correction									
	1	0,7	0,8	0,9	1,1	1,2	1,5	1,6	1,8	1,9
1	0,003	0,002	0,002	0,003	0,003	0,004	0,005	0,005	0,005	0,006
2	0,008	0,006	0,006	0,007	0,009	0,010	0,012	0,013	0,014	0,015
3	0,012	0,008	0,010	0,011	0,013	0,014	0,018	0,019	0,022	0,023
4	0,014	0,010	0,011	0,013	0,015	0,017	0,021	0,022	0,025	0,027
5	0,017	0,012	0,014	0,015	0,019	0,020	0,026	0,027	0,031	0,032
6	0,020	0,014	0,016	0,018	0,022	0,024	0,030	0,032	0,036	0,038
8	0,027	0,019	0,022	0,024	0,030	0,032	0,041	0,043	0,049	0,051
10	0,033	0,023	0,026	0,030	0,036	0,040	0,050	0,053	0,059	0,063
12	0,040	0,028	0,032	0,036	0,044	0,048	0,060	0,064	0,072	0,076
14	0,047	0,033	0,038	0,042	0,052	0,056	0,071	0,075	0,085	0,089
16	0,053	0,037	0,042	0,048	0,058	0,064	0,080	0,085	0,095	0,101
18	0,060	0,042	0,048	0,054	0,066	0,072	0,090	0,096	0,108	0,114
20	0,067	0,047	0,054	0,060	0,074	0,080	0,101	0,107	0,121	0,127
25	0,083	0,058	0,066	0,075	0,091	0,100	0,125	0,133	0,149	0,158

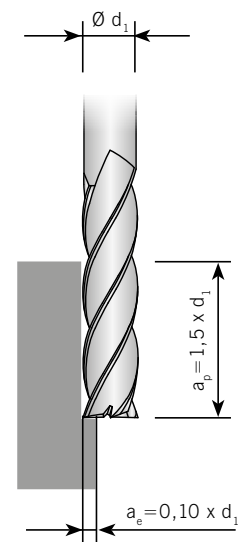

**Achtung:** Korrekturfaktor aus der Tabelle "Schnittgeschwindigkeiten" entnehmen.  
Korrekturfaktor -> 1,1 bei  $a_p = 1 \times d_1$  -> 1,2 bei  $a_p = 0,5 \times d_1$

Attention: Take the correction factor from the table "Cutting speeds".  
Correction factor -> 1,1 with  $a_p = 1 \times d_1$  -> 1,2 with  $a_p = 0,5 \times d_1$

Attention: Prenez le facteur de correction du tableau «Vitesses de coupe».  
Facteur de correction -> 1,1 pour  $a_p = 1 \times d_1$  -> 1,2 pour  $a_p = 0,5 \times d_1$



**Vorschub pro Zahn bei einer radialen Zustellung 20% vom Schneidendurchmesser ( $\varnothing d_1$ )**

Feed per tooth with radial depth of cut of 20% of the cutter ( $\varnothing d_1$ )

Avance par dent avec un engagement radial de 20% du diamètre de coupe ( $\varnothing d_1$ )

$\varnothing d_1$ [mm]	Korrekturfaktor / Correction factor / Facteur de correction									
	1	0,7	0,8	0,9	1,1	1,2	1,5	1,6	1,8	1,9
1	0,002	0,001	0,001	0,001	0,002	0,002	0,003	0,003	0,003	0,003
2	0,005	0,003	0,004	0,004	0,005	0,006	0,007	0,008	0,009	0,009
3	0,008	0,005	0,006	0,007	0,008	0,009	0,012	0,012	0,014	0,015
4	0,010	0,007	0,008	0,009	0,011	0,012	0,015	0,016	0,018	0,019
5	0,013	0,009	0,010	0,011	0,014	0,015	0,019	0,020	0,023	0,024
6	0,015	0,010	0,012	0,013	0,016	0,018	0,022	0,024	0,027	0,028
8	0,020	0,014	0,016	0,018	0,022	0,024	0,030	0,032	0,036	0,038
10	0,025	0,017	0,020	0,022	0,027	0,030	0,037	0,040	0,045	0,047
12	0,030	0,021	0,024	0,027	0,033	0,036	0,045	0,048	0,054	0,057
14	0,035	0,024	0,028	0,031	0,038	0,042	0,052	0,056	0,063	0,066
16	0,040	0,028	0,032	0,036	0,044	0,048	0,060	0,064	0,072	0,076
18	0,045	0,031	0,036	0,040	0,049	0,054	0,067	0,072	0,081	0,085
20	0,050	0,035	0,040	0,045	0,055	0,060	0,075	0,080	0,090	0,095
25	0,063	0,044	0,050	0,056	0,069	0,075	0,094	0,100	0,113	0,119

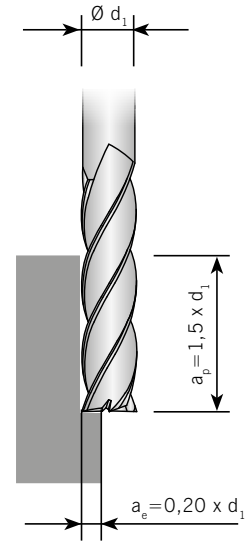

**Vorschub pro Zahn bei einer radialen Zustellung 40% vom Schneidendurchmesser ( $\varnothing d_1$ )**

Feed per tooth with radial depth of cut of 40% of the cutter ( $\varnothing d_1$ )

Avance par dent avec un engagement radial de 40% du diamètre de coupe ( $\varnothing d_1$ )

$\varnothing d_1$ [mm]	Korrekturfaktor / Correction factor / Facteur de correction									
	1	0,7	0,8	0,9	1,1	1,2	1,5	1,6	1,8	1,9
1	0,001	0,001	0,001	0,001	0,001	0,001	0,002	0,002	0,002	0,003
2	0,004	0,002	0,003	0,003	0,004	0,004	0,006	0,006	0,007	0,007
3	0,006	0,004	0,005	0,005	0,007	0,007	0,009	0,010	0,011	0,012
4	0,008	0,005	0,006	0,007	0,008	0,009	0,012	0,012	0,014	0,015
5	0,010	0,007	0,008	0,009	0,011	0,012	0,015	0,016	0,018	0,019
6	0,012	0,008	0,009	0,010	0,013	0,014	0,018	0,019	0,021	0,022
8	0,016	0,011	0,012	0,014	0,017	0,019	0,024	0,025	0,028	0,030
10	0,020	0,014	0,016	0,018	0,022	0,024	0,030	0,032	0,036	0,038
12	0,024	0,016	0,019	0,021	0,026	0,028	0,036	0,038	0,043	0,045
14	0,028	0,019	0,022	0,025	0,030	0,033	0,042	0,044	0,050	0,053
16	0,032	0,022	0,025	0,028	0,035	0,038	0,048	0,051	0,057	0,060
18	0,036	0,025	0,028	0,032	0,039	0,043	0,054	0,057	0,064	0,068
20	0,040	0,028	0,032	0,036	0,044	0,048	0,060	0,064	0,072	0,076
25	0,050	0,035	0,040	0,045	0,055	0,060	0,075	0,080	0,090	0,095

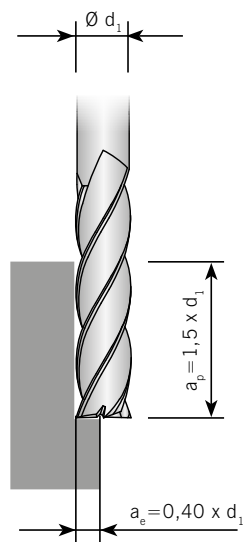

Achtung: Korrekturfaktor aus der Tabelle "Schnittgeschwindigkeiten" entnehmen.  
Korrekturfaktor -> 1,1 bei  $a_p = 1 \times d_1$  -> 1,2 bei  $a_p = 0,5 \times d_1$

Attention: Take the correction factor from the table "Cutting speeds".  
Correction factor -> 1,1 with  $a_p = 1 \times d_1$  -> 1,2 with  $a_p = 0,5 \times d_1$

Attention: Prenez le facteur de correction du tableau «Vitesse de coupe».  
Facteur de correction -> 1,1 pour  $a_p = 1 \times d_1$  -> 1,2 pour  $a_p = 0,5 \times d_1$

**Vorschub pro Zahn bei einer radialen Zustellung 60% vom Schneidendurchmesser ( $\varnothing d_1$ )**

Feed per tooth with radial depth of cut of 60% of the cutter ( $\varnothing d_1$ )

Avance par dent avec un engagement radial de 60% du diamètre de coupe ( $\varnothing d_1$ )

$\varnothing d_1$ [mm]	Korrekturfaktor / Correction factor / Facteur de correction									
	1	0,7	0,8	0,9	1,1	1,2	1,5	1,6	1,8	1,9
1	0,001	0,001	0,001	0,001	0,001	0,001	0,001	0,002	0,002	0,002
2	0,003	0,002	0,002	0,002	0,003	0,003	0,004	0,005	0,005	0,006
3	0,005	0,003	0,004	0,004	0,005	0,006	0,007	0,008	0,009	0,009
4	0,006	0,004	0,005	0,005	0,007	0,007	0,009	0,010	0,011	0,012
5	0,008	0,005	0,006	0,007	0,009	0,010	0,012	0,013	0,015	0,016
6	0,009	0,006	0,007	0,008	0,010	0,011	0,014	0,015	0,017	0,018
8	0,013	0,009	0,010	0,011	0,014	0,015	0,019	0,020	0,023	0,024
10	0,016	0,011	0,013	0,014	0,017	0,019	0,024	0,026	0,029	0,030
12	0,019	0,013	0,015	0,017	0,021	0,023	0,029	0,031	0,035	0,037
14	0,022	0,015	0,018	0,020	0,025	0,027	0,034	0,036	0,040	0,043
16	0,026	0,018	0,020	0,023	0,028	0,031	0,039	0,041	0,046	0,049
18	0,029	0,020	0,023	0,026	0,032	0,035	0,043	0,046	0,052	0,055
20	0,032	0,022	0,026	0,029	0,035	0,039	0,048	0,052	0,058	0,061
25	0,040	0,028	0,032	0,036	0,045	0,049	0,061	0,065	0,073	0,077

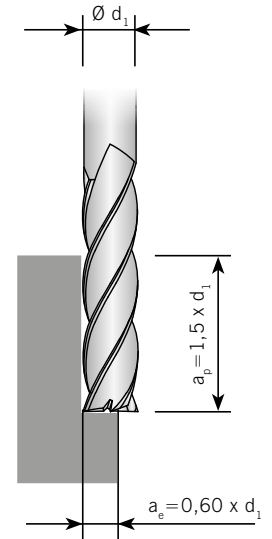

**Vorschub pro Zahn bei einer radialen Zustellung 80% vom Schneidendurchmesser ( $\varnothing d_1$ )**

Feed per tooth with radial depth of cut of 80% of the cutter ( $\varnothing d_1$ )

Avance par dent avec un engagement radial de 80% du diamètre de coupe ( $\varnothing d_1$ )

$\varnothing d_1$ [mm]	Korrekturfaktor / Correction factor / Facteur de correction									
	1	0,7	0,8	0,9	1,1	1,2	1,5	1,6	1,8	1,9
1	0,001	0,001	0,001	0,001	0,001	0,001	0,001	0,001	0,001	0,001
2	0,002	0,001	0,002	0,002	0,002	0,003	0,003	0,004	0,004	0,004
3	0,004	0,002	0,003	0,003	0,004	0,004	0,006	0,006	0,007	0,007
4	0,005	0,003	0,004	0,004	0,005	0,006	0,007	0,008	0,009	0,009
5	0,006	0,004	0,005	0,005	0,007	0,007	0,009	0,010	0,011	0,012
6	0,007	0,005	0,006	0,006	0,008	0,009	0,011	0,012	0,013	0,014
8	0,010	0,007	0,008	0,009	0,011	0,012	0,015	0,016	0,018	0,019
10	0,012	0,008	0,010	0,011	0,013	0,015	0,018	0,020	0,022	0,023
12	0,015	0,010	0,012	0,013	0,016	0,018	0,022	0,024	0,027	0,028
14	0,017	0,012	0,014	0,015	0,019	0,021	0,026	0,028	0,031	0,033
16	0,020	0,014	0,016	0,018	0,022	0,024	0,030	0,032	0,036	0,038
18	0,022	0,015	0,018	0,020	0,024	0,027	0,033	0,036	0,040	0,042
20	0,025	0,017	0,020	0,022	0,027	0,030	0,037	0,040	0,045	0,047
25	0,031	0,022	0,025	0,028	0,034	0,037	0,047	0,050	0,056	0,059

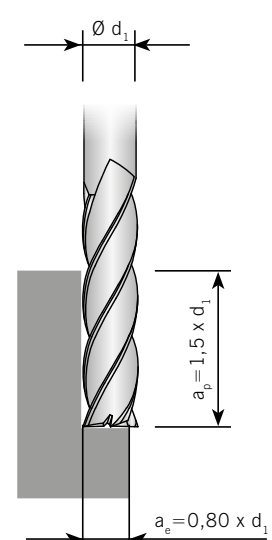

Achtung: Korrekturfaktor aus der Tabelle "Schnittgeschwindigkeiten" entnehmen.  
Korrekturfaktor -> 1,1 bei  $a_p = 1 \times d_1$  -> 1,2 bei  $a_p = 0,5 \times d_1$

Attention: Take the correction factor from the table "Cutting speeds".  
Correction factor -> 1,1 with  $a_p = 1 \times d_1$  -> 1,2 with  $a_p = 0,5 \times d_1$

Attention: Prenez le facteur de correction du tableau «Vitesses de coupe».  
Facteur de correction -> 1,1 pour  $a_p = 1 \times d_1$  -> 1,2 pour  $a_p = 0,5 \times d_1$

AFJ

Recommended cutting data feed tables

Tableaux des avances valeurs de coupe recommandées

**Vorschub pro Zahn beim Vollnutfräsen →  $a_p = 0,5 \times d_1$**

Feed per tooth when full slot milling →  $a_p = 0,5 \times d_1$

Avance par dent pour le rainurage →  $a_p = 0,5 \times d_1$

Ø d <sub>1</sub> [mm]	Korrekturfaktor / Correction factor / Facteur de correction									
	1	0,7	0,8	0,9	1,1	1,2	1,5	1,6	1,8	1,9
1	0,002	0,001	0,001	0,001	0,002	0,002	0,003	0,003	0,003	0,003
2	0,004	0,002	0,003	0,003	0,004	0,004	0,006	0,006	0,007	0,007
3	0,007	0,004	0,005	0,006	0,007	0,008	0,010	0,011	0,012	0,013
4	0,009	0,006	0,007	0,008	0,009	0,010	0,013	0,014	0,016	0,017
5	0,011	0,007	0,008	0,009	0,012	0,013	0,016	0,017	0,019	0,020
6	0,013	0,009	0,010	0,011	0,014	0,015	0,019	0,020	0,023	0,024
8	0,018	0,012	0,014	0,016	0,019	0,021	0,027	0,028	0,032	0,034
10	0,022	0,015	0,017	0,019	0,024	0,026	0,033	0,035	0,039	0,041
12	0,030	0,021	0,024	0,027	0,033	0,036	0,045	0,048	0,054	0,057
14	0,032	0,022	0,025	0,028	0,035	0,038	0,048	0,051	0,057	0,060
16	0,036	0,025	0,028	0,032	0,039	0,043	0,054	0,057	0,064	0,068
18	0,042	0,029	0,033	0,037	0,046	0,050	0,063	0,067	0,075	0,079
20	0,045	0,031	0,036	0,040	0,049	0,054	0,067	0,072	0,081	0,085
25	0,056	0,039	0,044	0,050	0,061	0,067	0,084	0,089	0,100	0,106

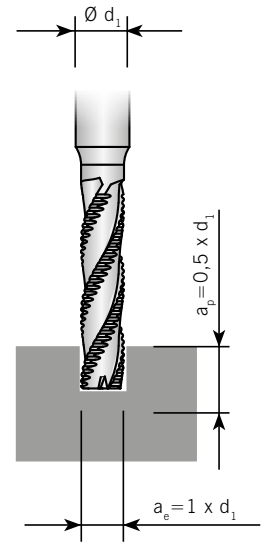

**Vorschub pro Zahn beim Vollnutfräsen →  $a_p = 1 \times d_1$**

Feed per tooth when full slot milling →  $a_p = 1 \times d_1$

Avance par dent pour le rainurage →  $a_p = 1 \times d_1$

Ø d <sub>1</sub> [mm]	Korrekturfaktor / Correction factor / Facteur de correction									
	1	0,7	0,8	0,9	1,1	1,2	1,5	1,6	1,8	1,9
1	0,001	0,001	0,001	0,001	0,001	0,002	0,002	0,002	0,002	0,002
2	0,003	0,002	0,002	0,002	0,003	0,003	0,004	0,004	0,005	0,005
3	0,005	0,003	0,004	0,004	0,005	0,005	0,007	0,007	0,008	0,009
4	0,006	0,004	0,005	0,005	0,006	0,007	0,009	0,009	0,011	0,011
5	0,007	0,005	0,006	0,006	0,008	0,009	0,011	0,011	0,013	0,014
6	0,008	0,006	0,007	0,008	0,009	0,010	0,013	0,014	0,015	0,016
8	0,012	0,008	0,009	0,011	0,013	0,014	0,018	0,019	0,021	0,022
10	0,014	0,010	0,011	0,013	0,016	0,017	0,021	0,023	0,026	0,027
12	0,020	0,014	0,016	0,018	0,021	0,023	0,029	0,031	0,035	0,037
14	0,021	0,015	0,017	0,019	0,023	0,025	0,031	0,033	0,037	0,040
16	0,023	0,016	0,019	0,021	0,026	0,028	0,035	0,037	0,042	0,044
18	0,027	0,019	0,022	0,025	0,030	0,033	0,041	0,044	0,049	0,052
20	0,029	0,020	0,023	0,026	0,032	0,035	0,044	0,047	0,053	0,056
25	0,036	0,025	0,029	0,033	0,040	0,044	0,055	0,058	0,066	0,069

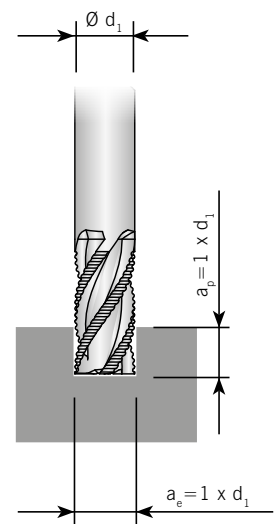

**Achtung:** Für unbeschichtete Werkzeuge ist der Vorschub um 10-20% zu reduzieren.

Attention: Feed rates are reduced by 10-20% for uncoated tools.

Attention: Pour les outils sans revêtement, l'avance doit être réduite de 10 à 20 %.

Vorschübe für Vollradius- und Torusfräser

Feed rates for ball nosed- and High feed cutters

Avances pour les fraises à rayon complet et toriques

Radiusfräser Ball nose end milling cutters Fraise à rayon		Radiusfräser Ball nose end milling cutters Fraise à rayon		Formenbau-Radiusfräser Ball nose cutter for mold and die production Fraise à rayon pour la fabrication de moules		Torusfräser Torus end milling cutters Fraise torique		Torusfräser Torus end milling cutters Fraise torique	
$d_1$ [mm]	fz [mm]	fz [mm]	fz [mm]	fz [mm]	fz [mm]	fz [mm]	fz [mm]	fz [mm]	fz [mm]
2	0,015	0,010	0,005	0,010	0,015	0,010	0,015	0,015	0,020
3	0,030	0,020	0,015	0,015	0,020	0,015	0,020	0,030	0,030
4	0,040	0,030	0,030	0,030	0,040	0,020	0,030	0,060	0,060
5	0,060	0,050	0,050	0,050	0,060	0,030	0,040	0,070	0,080
6	0,070	0,060	0,060	0,060	0,070	0,050	0,060	0,100	0,100
8	0,100	0,080	0,070	0,080	0,100	0,070	0,080	0,120	0,120
10	0,120	0,100	0,080	0,100	0,120	0,080	0,100	0,150	0,150
12	0,150	0,120	0,090	0,100	0,120	0,100	0,120	0,180	0,180
16	0,180	0,150	0,100	0,120	0,150	0,120	0,150	0,200	0,200
18	0,200	0,180	0,110	0,140	0,160	0,140	0,160	0,220	0,220
20	0,220	0,200	0,120	0,150	0,180	0,150	0,180	0,250	0,250
25	0,250	0,240	0,140	0,170	0,200	0,170	0,200		

Achtung: Für unbeschichtete Werkzeuge ist der Vorschub um 10-20% zu reduzieren.

Attention: Feed rates are reduced by 10-20% for uncoated tools.

Attention : Pour les outils sans revêtement, l'avance doit être réduite de 10 à 20 %.

# ARNO<sup>®</sup>

## WERKZEUGE

We have a passion for precision.

# AUSFÜHRUNG AFR

*Design AFR / Modèle AFR*

## Schruppfräsen ganz nach Ihrem Bedarf.

Roughing to your requirements.

Le fraisage d'ébauche parfaitement adapté à vos besoins.

Die AFR Schruppfräser - mit ungleicher Drallsteigung von 43° - 46° - sind für die Bearbeitung legierter und unlegierter Stähle und Werkzeugstähle, sowie Gusseisen und gehärteten Werkstoffen bis 40 HRC optimal geeignet.



*The cutter design with uneven pitch, 43°-46°, is suitable for milling alloy steel, non-alloy steel, cast iron and hardened materials up to 40HRC.*

Les fraises d'ébauche AFR à pas inégal de 43° à 46° sont parfaitement adaptées pour l'usinage d'aciers alliés et non alliés, d'aciers à outils, de fontes et de matières trempées jusqu'à 40 HRC.

Solid carbide roughing end-mill  
Fraise carbure monobloc d'ébauche

## AFR619.0-...

4-5 Schneiden, kurze Ausführung / 4-5 flutes, short design / 4 - 5 dents, version courte

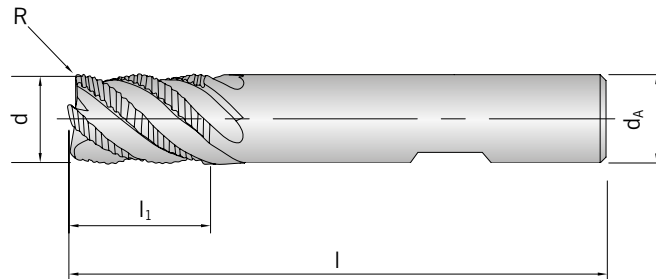
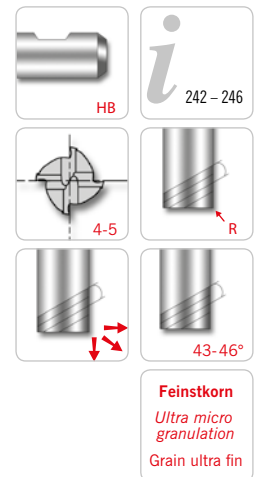

							PG 24
							beschichtet coated revêtu
Schaft DIN 6535HB Shank Tige	d -0,05	d <sub>A</sub> h6	l <sub>1</sub>	l	R	z	AlCrN
AFR61940-060	6	6	9	57	0,5	4	●
AFR61940-080	8	8	12	63	0,5	4	●
AFR61940-100	10	10	15	72	0,5	4	●
AFR61940-120	12	12	18	83	0,5	4	●
AFR61950-160	16	16	24	92	1,0	5	●
AFR61950-200	20	20	30	104	1,0	5	●

P	●
M	●
K	●
N	
S	
H	

● Hauptanwendung  
Main application  
Application principale

○ Nebenanwendung  
Secondary application  
Application secondaire

AFR

Solid carbide roughing end-mill  
Fraise carbure monobloc d'ébauche

## AFR619.1-...

4-5 Schneiden, extra lange Ausführung / 4-5 flutes, extra long design / 4 - 5 dents, version extra longue

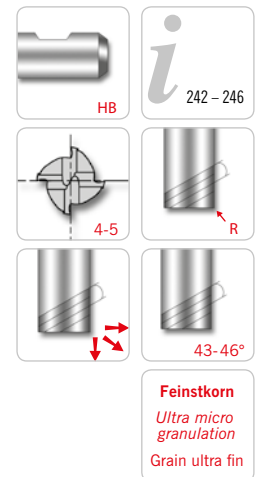
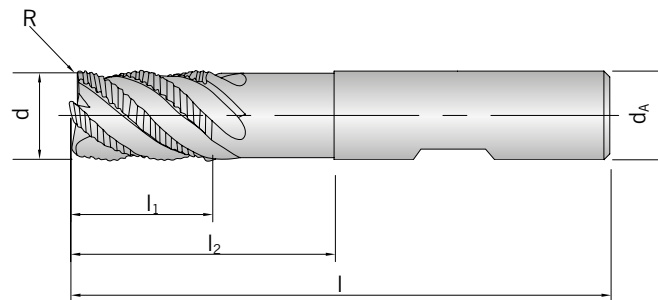

									PG 24
									beschichtet coated revêtu
Schaft DIN 6535HB Shank Tige	d -0,05	d <sub>A</sub> h6	l <sub>1</sub>	l <sub>2</sub>	l	R	z	AICrN	
AFR61941-060	6	6	9	18	57	0,5	4	●	
AFR61941-080	8	8	12	24	63	0,5	4	●	
AFR61941-100	10	10	15	30	72	0,5	4	●	
AFR61941-120	12	12	18	36	83	0,5	4	●	
AFR61951-160	16	16	24	48	100	1,0	5	●	
AFR61951-200	20	20	30	60	110	1,0	5	●	

P	●
M	●
K	●
N	
S	
H	

● Hauptanwendung  
Main application  
Application principale

○ Nebenanwendung  
Secondary application  
Application secondaire

AFR

Solid carbide roughing end-mill  
Fraise carbure monobloc d'ébauche

## AFR619.2-...

4-5 Schneiden, lange Ausführung / 4-5 flutes, long design / 4 - 5 dents, version longue

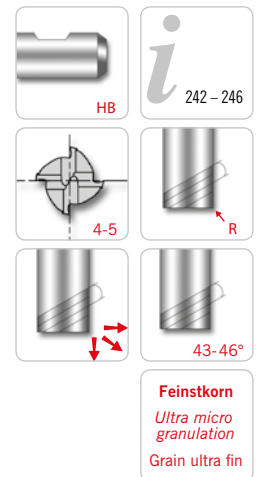
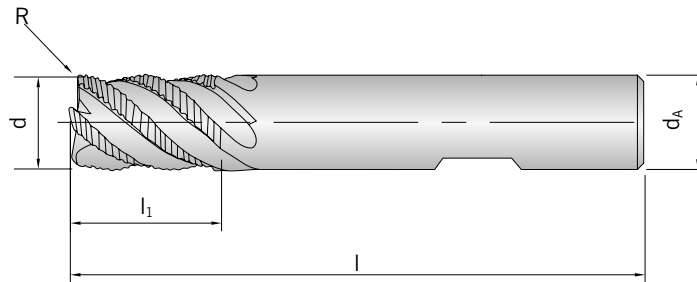

								PG 24
								beschichtet coated revêtu
Schaft DIN 6535HB Shank Tige	d -0,05	d <sub>A</sub> h6	l <sub>1</sub>	l	R	z	TiAlN	
AFR61942-060	6	6	12	57	0,5	4	●	
AFR61942-080	8	8	16	63	0,5	4	●	
AFR61942-100	10	10	20	72	0,5	4	●	
AFR61942-120	12	12	24	83	0,5	4	●	
AFR61952-160	16	16	32	92	1,0	5	●	
AFR61952-200	20	20	40	104	1,0	5	●	

P	●
M	●
K	●
N	
S	
H	

● Hauptanwendung  
Main application  
Application principale  
○ Nebenanwendung  
Secondary application  
Application secondaire

AFR



PM-HSS roughing end-mill  
Fraise d'ébauche-PM-HSS

## AFR619.3-...-PM

4-5 Schneiden, lange Ausführung / 4-5 flutes, long design / 4 - 5 dents, version longue

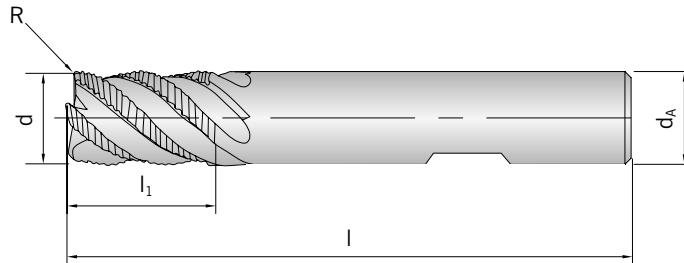
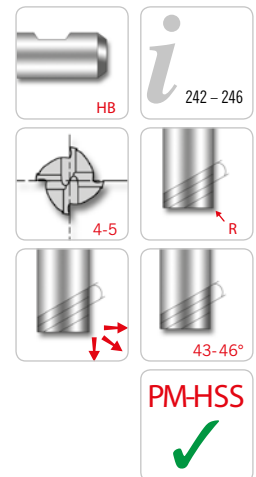

							PG 24
							beschichtet coated revêtu
Schaft DIN 6535HB Shank Tige	d js12	d <sub>A</sub> h6	l <sub>1</sub>	l	R	z	TiAIN
AFR61943-060-PM	6	6	13	57	0,5	4	●
AFR61943-080-PM	8	10	19	69	0,5	4	●
AFR61943-100-PM	10	10	22	72	0,5	4	●
AFR61943-120-PM	12	12	26	83	0,5	4	●
AFR61953-160-PM	16	16	32	92	1,0	5	●
AFR61953-200-PM	20	20	38	104	1,0	5	●

P	●
M	●
K	●
N	
S	
H	

● Hauptanwendung  
Main application  
Application principale

○ Nebenanwendung  
Secondary application  
Application secondaire

AFR

Werkstoffgruppe	Gliederung der Werkstoffhauptgruppen und Kennbuchstaben		Brinell-Härte	Zugfestigkeit Rm (N/mm <sup>2</sup> )	Zerspanungsgruppe	Korrekturfaktor	Schnittgeschwindigkeit V <sub>c</sub> (m/min)	
							VHM AlCrN	PM-HSS TiAlN
P	Unlegierter Stahl	C ≤ 0,25 % geglüht	125	428	P1	1,2	150 - 175 - 200	50 - 60 - 70
		C > 0,25 ... ≤ 0,55 % geglüht	190	639	P2	1,2	140 - 165 - 190	50 - 60 - 70
		C > 0,25 ... ≤ 0,55 % vergütet	210	708	P3	1,2	140 - 165 - 190	25 - 33 - 40
		C > 0,55 % geglüht	190	639	P4	1,2	140 - 165 - 190	50 - 60 - 70
		C > 0,55 % vergütet	300	1013	P5	1,0	120 - 140 - 160	25 - 33 - 40
		Automatenstahl (kurzspanend) geglüht	220	745	P6	1,2	170 - 195 - 220	50 - 60 - 70
	Niedrig legierter Stahl	geglüht	175	591	P7	1,2	100 - 135 - 170	25 - 33 - 40
		vergütet	300	1013	P8	1,0	100 - 140 - 180	25 - 33 - 40
		vergütet	380	1282	P9	0,8	100 - 130 - 160	25 - 33 - 40
		vergütet	430	1477	P10	0,8	100 - 130 - 160	25 - 30 - 35
	Hochlegierter Stahl und hochlegierter Werkzeugstahl	geglüht	200	675	P11	1,2	100 - 135 - 170	25 - 33 - 40
		gehärtet und angelassen	300	1013	P12	1,0	-	25 - 30 - 35
		gehärtet und angelassen	400	1361	P13	0,8	80 - 115 - 150	20 - 28 - 35
	Nichtrostender Stahl	ferritisch / martensitisch, geglüht	200	675	P14	1,0	-	20 - 28 - 35
		martensitisch, vergütet	330	1114	P15	0,9	-	20 - 25 - 30
austenitisch, abgeschreckt		200	675	M1	1,0	-	25 - 30 - 35	
M	Nichtrostender Stahl	austenitisch, ausscheidungsgehärtet (PH)	300	1013	M2	0,9	-	10 - 18 - 25
		austenitisch-ferritisch, Duplex	230	778	M3	1,0	-	20 - 28 - 35
		ferritisch	200	675	K1	1,0	100 - 120 - 140	30 - 38 - 45
K	Temperguss	perritisch	260	867	K2	0,8	80 - 100 - 120	25 - 33 - 40
		niedrige Festigkeit	180	602	K3	1,0	100 - 125 - 150	35 - 45 - 55
	Grauguss	hohe Festigkeit / austenitisch	245	825	K4	1,0	100 - 120 - 140	25 - 33 - 40
		ferritisch	155	518	K5	1,0	100 - 120 - 140	30 - 38 - 45
	Gusseisen mit Kugelgraphit	perritisch	265	885	K6	1,0	80 - 100 - 120	30 - 38 - 45
		GGV (CGI)	200	675	K7	1,0	100 - 120 - 140	30 - 38 - 45
N	Aluminium-Knetlegierungen	nicht aushärtbar	30	-	N1		-	-
		aushärtbar, ausgehärtet	100	343	N2		-	-
	Aluminium-Gusslegierungen	≤ 12 % Si, nicht aushärtbar	75	260	N3		-	-
		≤ 12 % Si, aushärtbar, ausgehärtet	90	314	N4		-	-
		> 12 % Si, nicht aushärtbar	130	447	N5		-	-
	Magnesiumlegierungen		70	250	N6		-	-
	Kupfer und Kupferlegierungen (Bronze / Messing)	unlegiert, Elektrolytkupfer	100	343	N7		-	-
		Messing, Bronze, Rotguss	90	314	N8		-	-
		Cu-Legierung, kurzspanend	110	382	N9		-	-
		hochfest, Ampco	300	1013	N10		-	-
Nichtmetallische Werkstoffe	Thermoplaste (ohne abrasive Füllstoffe)	-	-	N11		-	-	
	Duroplaste (ohne abrasive Füllstoffe)	-	-	N12		-	-	
	Kunststoff glasfaserverstärkt GFRP	-	-	N13		-	-	
	Kunststoff kohlefaserverstärkt CFRP	-	-	N14		-	-	
	Kunststoff aramidfaserverstärkt AFRP	-	-	N15		-	-	
	Graphit (technisch)	80 Shore	-	N16		-	-	
S	Warmfeste Legierungen	Fe-Basis geglüht	200	675	S1		-	-
		ausgehärtet	280	943	S2		-	-
		geglüht	250	839	S3		-	-
		Ni- oder Co-Basis ausgehärtet	350	1177	S4		-	-
		gegossen	320	1076	S5		-	-
	Titanlegierungen	Reintitan	200	675	S6		-	-
		α- und β-Legierungen, ausgehärtet	375	1262	S7		-	-
		β-Legierungen	410	1396	S8		-	-
	Wolframlegierungen		300	1013	S9		-	-
	Molybdänlegierungen		300	1013	S10		-	-
H	Gehärteter Stahl	gehärtet und angelassen	50 HRC	-	H1		-	-
		gehärtet und angelassen	55 HRC	-	H2		-	-
		gehärtet und angelassen	60 HRC	-	H3		-	-
	Gehärtetes Gusseisen	gehärtet und angelassen	55 HRC	-	H4		-	-

Die Tabellenwerte sind Richtwerte. Es kann notwendig sein, die Werte den jeweiligen Bearbeitungsumständen anzupassen.

Material group	Structure of the material groups and identification letters		Brinell hardness HB	Tensile strength Rm (N/mm <sup>2</sup> )	Chipping group	Correction factor	Cutting speed V <sub>c</sub> (m/min)		
							VHM AlCrN	PM-HSS TiAlN	
P	Unalloyed steel	C ≤ 0.25 % annealed	125	428	P1	1,2	150 - 175 - 200	50 - 60 - 70	
		C > 0.25 ... ≤ 0.55 % annealed	190	639	P2	1,2	140 - 165 - 190	50 - 60 - 70	
		C > 0.25 ... ≤ 0.55 % hardened and tempered	210	708	P3	1,2	140 - 165 - 190	25 - 33 - 40	
		C > 0.55 % annealed	190	639	P4	1,2	140 - 165 - 190	50 - 60 - 70	
		C > 0.55 % hardened and tempered	300	1013	P5	1,0	120 - 140 - 160	25 - 33 - 40	
		Machining steel (short-chipping) tempered	220	745	P6	1,2	170 - 195 - 220	50 - 60 - 70	
	Low alloyed steel	annealed	175	591	P7	1,2	100 - 135 - 170	25 - 33 - 40	
		hardened and tempered	300	1013	P8	1,0	100 - 140 - 180	25 - 33 - 40	
		hardened and tempered	380	1282	P9	0,8	100 - 130 - 160	25 - 33 - 40	
		hardened and tempered	430	1477	P10	0,8	100 - 130 - 160	25 - 30 - 35	
	High alloyed steel and high alloyed tool steel	annealed	200	675	P11	1,2	100 - 135 - 170	25 - 33 - 40	
		hardened	300	1013	P12	1,0	-	25 - 30 - 35	
		hardened	400	1361	P13	0,8	80 - 115 - 150	20 - 28 - 35	
	Stainless steel	ferritic / martensitic, annealed	200	675	P14	1,0	-	20 - 28 - 35	
		martensitic, hardened and tempered	330	1114	P15	0,9	-	20 - 25 - 30	
M	Stainless steel	austenitic, chilled	200	675	M1	1,0	-	25 - 30 - 35	
		austenitic, precipitation-hardened (PH)	300	1013	M2	0,9	-	10 - 18 - 25	
		austenitic-ferritic, Duplex	230	778	M3	1,0	-	20 - 28 - 35	
K	Malleable cast iron	ferritic	200	675	K1	1,0	100 - 120 - 140	30 - 38 - 45	
		pearlitic	260	867	K2	0,8	80 - 100 - 120	25 - 33 - 40	
	Cast iron	low tensile strength	180	602	K3	1,0	100 - 125 - 150	35 - 45 - 55	
		high tensile strength / austenitic	245	825	K4	1,0	100 - 120 - 140	25 - 33 - 40	
	Cast iron with nodular graphite	ferritic	155	518	K5	1,0	100 - 120 - 140	30 - 38 - 45	
		pearlitic	265	885	K6	1,0	80 - 100 - 120	30 - 38 - 45	
	GGV (CGI)		200	675	K7	1,0	100 - 120 - 140	30 - 38 - 45	
N	Aluminium alloys long chipping	not heat treatable	30	-	N1		-	-	
		heat treatable, heat treated	100	343	N2		-	-	
	Casted aluminium alloys	≤ 12 % Si, not heat treatable	75	260	N3		-	-	
		≤ 12 % Si, aushärtbar, ausgehärtet	90	314	N4		-	-	
		> 12 % Si, not heat treatable	130	447	N5		-	-	
	Magnesium alloys		70	250	N6		-	-	
	Copper and copper alloys (Brass / Bronze)	Unalloyed, elektrolyte copper	100	343	N7		-	-	
		Brass, Bronze	90	314	N8		-	-	
		Cu-alloys, short-chipping	110	382	N9		-	-	
		High-tensile, Ampco	300	1013	N10		-	-	
	Non-ferrous materials	Lead alloys (without abrasive filling material)	-	-	N11		-	-	
		Duroplastic (without abrasive filling material)	-	-	N12		-	-	
		Plastic glas fibre reinforced GFRP	-	-	N13		-	-	
		Plastic carbon fibre reinforced CFRP	-	-	N14		-	-	
		Plastic aramid fibre reinforced AFRP	-	-	N15		-	-	
Graphite (tech.)		80 Shore	-	N16		-	-		
S	High temperature resistant alloys	Fe-Basis	annealed	200	675	S1		-	-
			heat treated	280	943	S2		-	-
		Ni- or Co-alloyed	annealed	250	839	S3		-	-
			heat treated	350	1177	S4		-	-
			casting	320	1076	S5		-	-
	Titanium alloys	Pure titan	200	675	S6		-	-	
		α- and β-alloys, heat treated	375	1262	S7		-	-	
		β-alloys	410	1396	S8		-	-	
	Wolfram alloys		300	1013	S9		-	-	
	Molybdän alloys		300	1013	S10		-	-	
H	Hardened steel	hardened	50 HRC	-	H1		-	-	
		hardened	55 HRC	-	H2		-	-	
		hardened	60 HRC	-	H3		-	-	
	Hardened cast iron	hardened	55 HRC	-	H4		-	-	

The recommended cutting data are only approximate values. It may be necessary to adjust them to each individual machining application.

ISO	Matériaux	Dureté Brinell	Résistance (N/mm <sup>2</sup> )	Groupe d'usinage	facteur de correction	Vitesse de coupe Vc (m/min)		
						VHM AlCrN	PM-HSS TiAlN	
P	Acier non allié	C ≤ 0,25 % recuit	125	428	P1	1,2	150 - 175 - 200	50 - 60 - 70
		C > 0,25 ... ≤ 0,55 % recuit	190	639	P2	1,2	140 - 165 - 190	50 - 60 - 70
		C > 0,25 ... ≤ 0,55 % traité	210	708	P3	1,2	140 - 165 - 190	25 - 33 - 40
		C > 0,55 % recuit	190	639	P4	1,2	140 - 165 - 190	50 - 60 - 70
		C > 0,55 % traité	300	1013	P5	1,0	120 - 140 - 160	25 - 33 - 40
		Aciers de décolletage (à copeaux courts) recuit	220	745	P6	1,2	170 - 195 - 220	50 - 60 - 70
	Acier faiblement allié	recuit	175	591	P7	1,2	100 - 135 - 170	25 - 33 - 40
		traité	300	1013	P8	1,0	100 - 140 - 180	25 - 33 - 40
		traité	380	1282	P9	0,8	100 - 130 - 160	25 - 33 - 40
		traité	430	1477	P10	0,8	100 - 130 - 160	25 - 30 - 35
	Acier allié et acier outil allié	recuit	200	675	P11	1,2	100 - 135 - 170	25 - 33 - 40
		trempe et revenu	300	1013	P12	1,0	-	25 - 30 - 35
		trempe et revenu	400	1361	P13	0,8	80 - 115 - 150	20 - 28 - 35
	Acier inox	ferritique, martensitique, recuit	200	675	P14	1,0	-	20 - 28 - 35
		martensitique, traité	330	1114	P15	0,9	-	20 - 25 - 30
M	Acier inox	austénitique	200	675	M1	1,0	-	25 - 30 - 35
		austénitique	300	1013	M2	0,9	-	10 - 18 - 25
		austénitique-ferritique, Duplex	230	778	M3	1,0	-	20 - 28 - 35
K	Fonte malléable	ferritique	200	675	K1	1,0	100 - 120 - 140	30 - 38 - 45
		perlitique	260	867	K2	0,8	80 - 100 - 120	25 - 33 - 40
	Fonte grise	faible résistance	180	602	K3	1,0	100 - 125 - 150	35 - 45 - 55
		haute résistance / austénitique	245	825	K4	1,0	100 - 120 - 140	25 - 33 - 40
	Fonte à Graphite sphéroïdale	ferritique	155	518	K5	1,0	100 - 120 - 140	30 - 38 - 45
		perlitique	265	885	K6	1,0	80 - 100 - 120	30 - 38 - 45
GGV (CGI)		200	675	K7	1,0	100 - 120 - 140	30 - 38 - 45	
N	Alliages de fonderie d'aluminium	ne pouvant pas subir un durcissement	30	-	N1		-	-
		pouvant subir un durcissement, durci	100	343	N2		-	-
		≤ 12 % Si, ne pouvant pas subir de durcissement	75	260	N3		-	-
	Alliage de fonte d'aluminium	≤ 12 % Si, pouvant subir un durcissement, durci	90	314	N4		-	-
		> 12 % Si, ne pouvant pas subir de durcissement	130	447	N5		-	-
	Alliage de Magnésium		70	250	N6		-	-
	Cuivre et alliage de cuivre (bronze / laiton)	non allié, cuivre électrolytique	100	343	N7		-	-
		Laiton, bronze, fonte rouge	90	314	N8		-	-
		Alliage de cuivre à copeaux courts	110	382	N9		-	-
		forte résistance, Ampco	300	1013	N10		-	-
Matériaux non métalliques	Thermoplaste (sans agents de charge abrasives)	-	-	N11		-	-	
	Duroplaste (sans agents de charge abrasives)	-	-	N12		-	-	
	Matière plastique renforcée de fibres de verre GFRP	-	-	N13		-	-	
	Matière plastique renforcé composite CFRP	-	-	N14		-	-	
	Plastique renforcé fibre aramide AFRP	-	-	N15		-	-	
	Graphite	80 Shore	-	N16		-	-	
S	Alliages réfractaires	à base de Fe recuit	200	675	S1		-	-
		durci	280	943	S2		-	-
		recuit	250	839	S3		-	-
		à base Ni ou Co durci	350	1177	S4		-	-
		jeter	320	1076	S5		-	-
	Alliage de titane	Titane pur	200	675	S6		-	-
		Alliages Alpha + Beta, trempé	375	1262	S7		-	-
		Alliages Beta	410	1396	S8		-	-
	Alliage de tungstène		300	1013	S9		-	-
	Alliage de molybdène		300	1013	S10		-	-
H	Acier trempé	trempe et revenu	50 HRC	-	H1		-	-
		trempe et revenu	55 HRC	-	H2		-	-
		trempe et revenu	60 HRC	-	H3		-	-
	Fonte durci	trempe et revenu	55 HRC	-	H4		-	-

Les valeurs du tableau sont indicatives. Il peut être nécessaire de les adapter aux conditions d'usinage respectives.

## VHM-Schaftfräser / Solid carbide end-mill / Fraise à queue en carbure monobloc

### Vorschub pro Zahn bei einer radialen Zustellung 50% vom Schneidendurchmesser ( $\varnothing d_1$ )

Feed per tooth with radial depth of cut of 50% of the cutter ( $\varnothing d_1$ )

Avance par dent avec un engagement radial de 50 % du diamètre de coupe ( $\varnothing d_1$ )

$\varnothing d_1$ [mm]	Korrekturfaktor / Correction factor / Facteur de correction						
	1	0,7	0,8	0,9	1,1	1,2	1,5
6	0,030	0,021	0,024	0,027	0,033	0,036	0,045
8	0,050	0,035	0,040	0,045	0,055	0,060	0,075
10	0,060	0,042	0,045	0,055	0,066	0,072	0,090
12	0,070	0,049	0,056	0,063	0,077	0,084	0,105
16	0,090	0,034	0,072	0,081	0,099	0,108	0,135
20	0,120	0,084	0,090	0,108	0,132	0,144	0,180

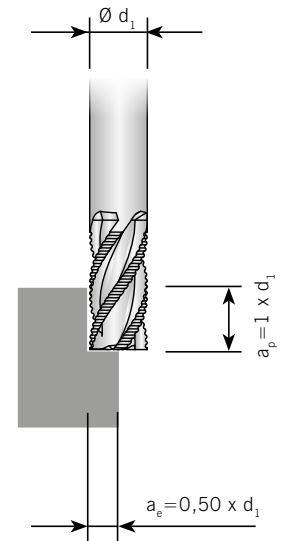

### Vorschub pro Zahn beim Vollnutfräsen $\rightarrow a_p = 1 \times d_1$

Feed per tooth when full slot milling  $\rightarrow a_p = 1 \times d_1$

Avance par dent pour le rainurage  $\rightarrow a_p = 1 \times d_1$

$\varnothing d_1$ [mm]	Korrekturfaktor / Correction factor / Facteur de correction						
	1	0,7	0,8	0,9	1,1	1,2	1,5
6	0,028	0,020	0,022	0,025	0,031	0,035	0,042
8	0,040	0,028	0,032	0,036	0,044	0,048	0,060
10	0,050	0,035	0,040	0,045	0,055	0,060	0,075
12	0,060	0,042	0,048	0,054	0,066	0,072	0,090
16	0,080	0,056	0,064	0,072	0,088	0,096	0,120
20	0,100	0,070	0,089	0,090	0,110	0,120	0,150

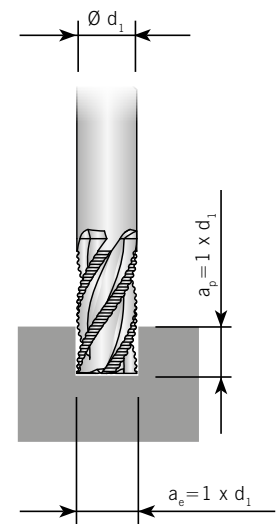

**Achtung:**

Korrekturfaktor aus der Tabelle "Schnittgeschwindigkeiten" entnehmen.  
Korrekturfaktor  $\rightarrow$  1,1 bei  $a_p = 1 \times d_1 \rightarrow$  1,2 bei  $a_p = 0,5 \times d_1$

**Attention:**

Take the correction factor from the table "Cutting speeds".

Correction factor  $\rightarrow$  1,1 with  $a_p = 1 \times d_1 \rightarrow$  1,2 with  $a_p = 0,5 \times d_1$

**Attention :**

Facteur de correction d'avance  $\rightarrow$  Kf fz = 1,10 pour  $a_p = 1 \times d_1$  et  $\rightarrow$  Kf fz = 1,25 pour  $a_p = 0,5 \times d_1$

Pour les outils sans revêtement, l'avance doit être réduite de 10 à 20 %.

PM-HSS Schafffräser / PM-HSS end-mill / Fraise à queue PM-HSS

Vorschub pro Zahn bei einer radialen Zustellung 50% vom Schneidendurchmesser ( $\varnothing d_1$ )

Feed per tooth with radial depth of cut of 50% of the cutter ( $\varnothing d_1$ )

Avance par dent avec un engagement radial de 50 % du diamètre de coupe ( $\varnothing d_1$ )

$\varnothing d_1$ [mm]	Korrekturfaktor / Correction factor / Facteur de correction						
	1	0,7	0,8	0,9	1,1	1,2	1,5
6	0,022	0,015	0,018	0,020	0,024	0,026	0,033
8	0,030	0,021	0,024	0,027	0,030	0,035	0,045
10	0,039	0,027	0,030	0,035	0,042	0,047	0,060
12	0,047	0,033	0,037	0,042	0,050	0,056	0,070
16	0,066	0,046	0,052	0,060	0,070	0,080	0,100
20	0,084	0,059	0,067	0,075	0,092	0,100	0,130

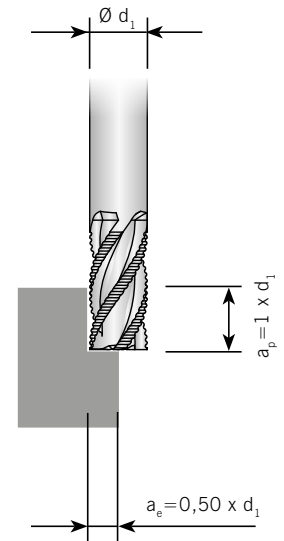

Vorschub pro Zahn beim Vollnutfräsen  $\rightarrow a_p = 1 \times d_1$

Feed per tooth when full slot milling  $\rightarrow a_p = 1 \times d_1$

Avance par dent pour le rainurage  $\rightarrow a_p = 1 \times d_1$

$\varnothing d_1$ [mm]	Korrekturfaktor / Correction factor / Facteur de correction						
	1	0,7	0,8	0,9	1,1	1,2	1,5
6	0,019	0,013	0,015	0,017	0,020	0,023	0,025
8	0,026	0,018	0,020	0,023	0,028	0,031	0,040
10	0,034	0,029	0,028	0,030	0,037	0,041	0,050
12	0,041	0,029	0,033	0,037	0,045	0,049	0,060
16	0,057	0,040	0,046	0,050	0,063	0,070	0,080
20	0,073	0,050	0,060	0,065	0,080	0,090	0,110

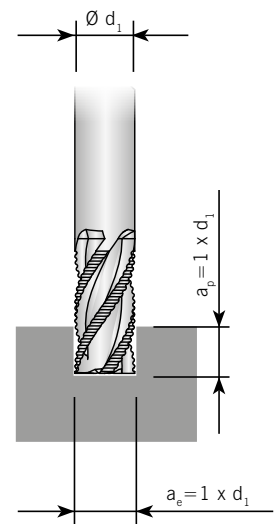

Achtung:

Korrekturfaktor aus der Tabelle "Schnittgeschwindigkeiten" entnehmen.  
Korrekturfaktor  $\rightarrow 1,1$  bei  $a_p = 1 \times d_1 \rightarrow 1,2$  bei  $a_p = 0,5 \times d_1$

Attention:

Take the correction factor from the table "Cutting speeds".

Correction factor  $\rightarrow 1,1$  with  $a_p = 1 \times d_1 \rightarrow 1,2$  with  $a_p = 0,5 \times d_1$

Attention :

Facteur de correction d'avance  $\rightarrow Kf fz = 1,10$  pour  $a_p = 1 \times d_1$  et  $\rightarrow Kf fz = 1,25$  pour  $a_p = 0,5 \times d_1$

Pour les outils sans revêtement, l'avance doit être réduite de 10 à 20 %.

AFR

# ARNO<sup>®</sup>

## WERKZEUGE

We have a passion for precision.

# AUSFÜHRUNG AFV

*Design AFV / Modèle AFV*

## Der Allrounder fürs Schruppen und Schlichten.

*General purpose high performance  
for roughing and finishing.*

*L'outil polyvalent pour l'ébauche et la finition.*

**VHM-Schaftfräser mit ungleicher Drallsteigung von 35° bis 38° sind für die Bearbeitung fast aller Werkstoffe geeignet – bei 60% höherem Vorschub, vibrationsfreiem Lauf, besserer Oberflächengüte und größeren Schnitttiefen.**



*Solid carbide cutters with uneven pitch design (35°-38°) for both roughing and finishing of nearly all materials with up to 60% higher feed rate, less vibration, better surface finish and increased cutting depth.*

Les fraises AFV en carbure monobloc à pas inégal de 35° à 38° sont adaptées à l'usinage de presque tous les matériaux : avec une vitesse d'avance jusqu'à 60 % plus élevée, un usinage sans vibrations, des états de surface améliorés et des profondeurs de coupe plus importantes.

Solid carbide end-mill with unequal pitch  
Fraise carbure monobloc à tige - à pas inégal

## AFV61840-...R...

4 Schneiden, kurze Ausführung / 4 flutes, short design / 4 dents, version courte

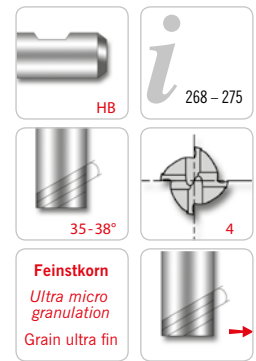
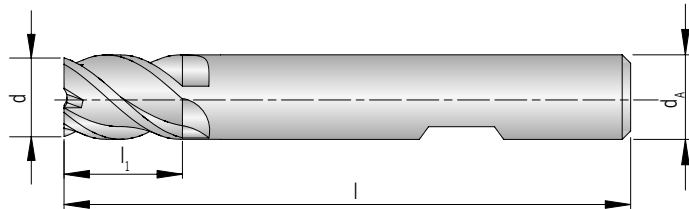

						PG 24
						beschichtet coated revêtu
Schaft DIN 6535HB Shank Tige	d -0,03	d <sub>A</sub> h6	l <sub>1</sub>	l	TiAIN	
AFV61840-030	3	6	7	54	●	
AFV61840-040	4	6	8	54	●	
AFV61840-050	5	6	10	54	●	
AFV61840-060	6	6	10	54	●	
AFV61840-080	8	8	12	58	●	
AFV61840-100	10	10	14	66	●	
AFV61840-120	12	12	16	73	●	
AFV61840-140	14	14	18	75	●	
AFV61840-160	16	16	22	82	●	
AFV61840-180	18	18	24	84	●	
AFV61840-200	20	20	26	92	●	

P	○
M	●
K	○
N	
S	○
H	

● Hauptanwendung  
Main application  
Application principale

○ Nebenanwendung  
Secondary application  
Application secondaire



Solid carbide end-mill with unequal pitch  
Fraise carbure monobloc à tige - à pas inégal

## AFV61840-...

4 Schneiden, kurze Ausführung / 4 flutes, short design / 4 dents, version courte

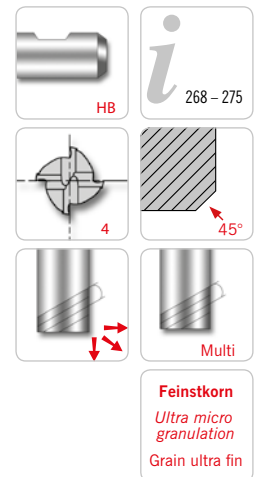
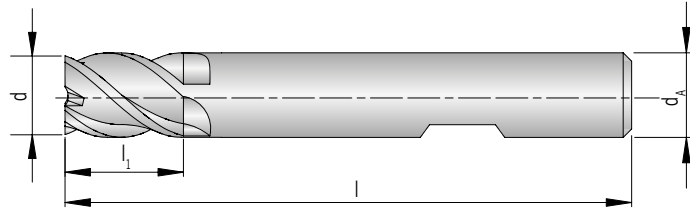

							PG 24
							beschichtet coated revêtu
Schaft DIN 6535HB Shank Tige	d -0,03	d <sub>A</sub> h6	l <sub>1</sub>	l	Fase / Chamfer	010	
AFV61840-030	3	6	7	54	0,1 x 45°	●	
AFV61840-040	4	6	8	54	0,15 x 45°	●	
AFV61840-050	5	6	10	54	0,15 x 45°	●	
AFV61840-060	6	6	10	54	0,2 x 45°	●	
AFV61840-080	8	8	12	58	0,2 x 45°	●	
AFV61840-100	10	10	14	66	0,3 x 45°	●	
AFV61840-120	12	12	16	73	0,35 x 45°	●	
AFV61840-140	14	14	18	75	0,4 x 45°	●	
AFV61840-160	16	16	22	82	0,4 x 45°	●	
AFV61840-180	18	18	24	84	0,5 x 45°	●	
AFV61840-200	20	20	26	92	0,5 x 45°	●	

P	●
M	●
K	●
N	○
S	○
H	○

● **Hauptanwendung**  
Main application  
Application principale

○ **Nebenanwendung**  
Secondary application  
Application secondaire

AFV

Solid carbide end-mill with unequal pitch  
Fraise carbure monobloc à tige - à pas inégal

## AFV61840-...R...

4 Schneiden, kurze Ausführung, mit Eckenradius / 4 flutes, short design, with corner radius / 4 dents, version courte avec rayon d'angle

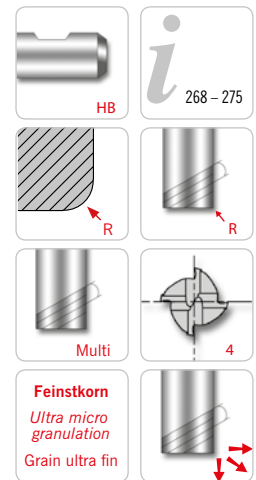
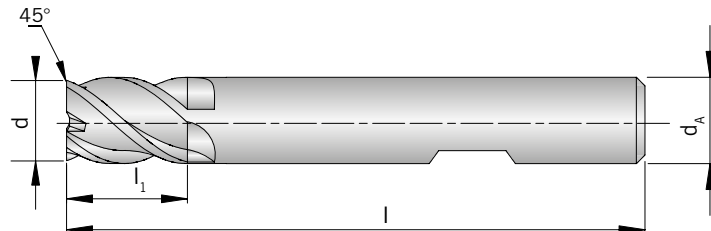

PG 24

beschichtet  
coated  
revêtu

Schaft DIN 6535HB Shank Tige	d -0,03	d <sub>A</sub> h6	l <sub>1</sub>	l	R	S100
AFV61840-030R0,3	3	6	7	54	0,3	●
AFV61840-030R0,5	3	6	7	54	0,5	●
AFV61840-040R0,3	4	6	8	54	0,3	●
AFV61840-040R0,5	4	6	8	54	0,5	●
AFV61840-050R0,3	5	6	10	54	0,3	●
AFV61840-050R0,5	5	6	10	54	0,5	●
AFV61840-060R0,3	6	6	10	54	0,3	●
AFV61840-060R0,5	6	6	10	54	0,5	●
AFV61840-060R1,0	6	6	10	54	1,0	●
AFV61840-080R0,5	8	8	12	58	0,5	●
AFV61840-080R1,0	8	8	12	58	1,0	●
AFV61840-100R0,5	10	10	14	66	0,5	●
AFV61840-100R1,0	10	10	14	66	1,0	●
AFV61840-120R0,5	12	12	16	73	0,5	●
AFV61840-120R1,0	12	12	16	73	1,0	●
AFV61840-120R2,0	12	12	16	73	2,0	●
AFV61840-140R0,5	14	14	18	75	0,5	●
AFV61840-160R1,0	16	16	22	82	1,0	●
AFV61840-160R2,0	16	16	22	82	2,0	●
AFV61840-160R3,0	16	16	22	82	3,0	●
AFV61840-180R1,0	18	18	24	84	1,0	●
AFV61840-200R1,0	20	20	26	92	1,0	●
AFV61840-200R2,0	20	20	26	92	2,0	●
AFV61840-200R3,0	20	20	26	92	3,0	●

● Hauptanwendung  
Main application  
Application principale  
○ Nebenanwendung  
Secondary application  
Application secondaire

P	●
M	●
K	●
N	●
S	●
H	●

AFV

Solid carbide end-mill with unequal pitch  
Fraise carbure monobloc à tige - à pas inégal

## AFV61840-...R...

4 Schneiden, kurze Ausführung, mit Eckenradius / 4 flutes, short design, with corner radius / 4 dents, version courte avec rayon d'angle

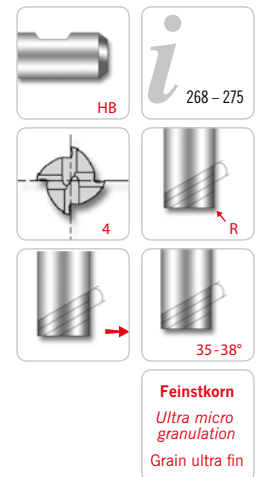
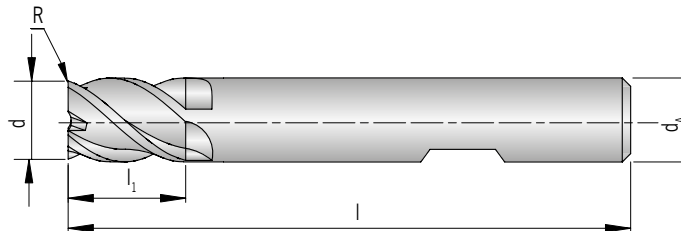

							PG 24
							beschichtet coated revêtu
Schaft DIN 6535HB Shank Tige	d -0,03	d <sub>A</sub> h6	l <sub>1</sub>	l	R	TiAIN	
AFV61840-030R0,3	3	6	7	54	0,3	●	
AFV61840-040R0,3	4	6	8	54	0,3	●	
AFV61840-050R0,3	5	6	10	54	0,3	●	
AFV61840-060R0,5	6	6	10	54	0,5	●	
AFV61840-080R0,5	8	8	12	58	0,5	●	
AFV61840-100R0,5	10	10	14	66	0,5	●	
AFV61840-120R0,7	12	12	16	73	0,7	●	
AFV61840-140R0,7	14	14	18	75	0,7	●	
AFV61840-160R1,0	16	16	22	82	1,0	●	
AFV61840-180R1,0	18	18	24	84	1,0	●	
AFV61840-200R1,0	20	20	26	92	1,0	●	

P	○
M	●
K	○
N	○
S	○
H	○

● Hauptanwendung  
Main application  
Application principale  
○ Nebenanwendung  
Secondary application  
Application secondaire

Solid carbide end-mill with unequal pitch  
Fraise carbure monobloc à tige - à pas inégal

## AFV62342-...

4 Schneiden, kurze Ausführung / 4 flutes, short design / 4 dents, version courte

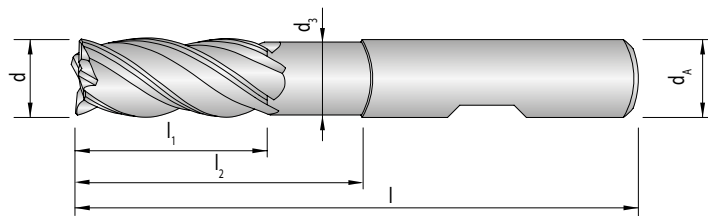
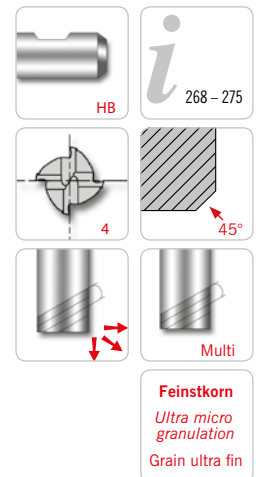

mit freigeschliffenem Schaft / with extended neck / avec tige affûtée

PG 24

beschichtet  
coated  
revêtu

Schaft DIN 6535HB Shank Tige	d -0,03	d <sub>A</sub> h6	d <sub>3</sub>	l <sub>1</sub>	l <sub>2</sub>	l	Fase / Chamfer	S100
AFV62342-030A	3	6	2,7	7	12	54	0,1 x 45°	●
AFV62342-030B	3	6	2,7	7	17	57	0,1 x 45°	●
AFV62342-030C	3	6	2,7	8	14	57	0,1 x 45°	●
AFV62342-040A	4	6	3,7	8	15	57	0,15 x 45°	●
AFV62342-040B	4	6	3,7	8	22	63	0,15 x 45°	●
AFV62342-040C	4	6	3,7	11	16	57	0,15 x 45°	●
AFV62342-050A	5	6	4,7	10	17	57	0,15 x 45°	●
AFV62342-050B	5	6	4,7	10	27	67	0,15 x 45°	●
AFV62342-050C	5	6	4,7	13	18	57	0,15 x 45°	●
AFV62342-060A	6	6	5,5	10	15	57	0,2 x 45°	●
AFV62342-060B	6	6	5,5	10	20	62	0,2 x 45°	●
AFV62342-060C	6	6	5,5	10	32	74	0,2 x 45°	●
AFV62342-060D	6	6	5,5	13	21	57	0,2 x 45°	●
AFV62342-080A	8	8	7,5	12	20	63	0,2 x 45°	●
AFV62342-080B	8	8	7,5	12	30	73	0,2 x 45°	●
AFV62342-080C	8	8	7,5	19	27	63	0,2 x 45°	●
AFV62342-080D	8	8	7,5	12	46	90	0,2 x 45°	●
AFV62342-100A	10	10	9,2	14	25	72	0,3 x 45°	●
AFV62342-100B	10	10	9,2	14	35	82	0,3 x 45°	●
AFV62342-100C	10	10	9,2	22	32	72	0,3 x 45°	●
AFV62342-100D	10	10	9,2	14	55	102	0,3 x 45°	●
AFV62342-120A	12	12	11,0	16	30	83	0,35 x 45°	●
AFV62342-120B	12	12	11,0	16	40	93	0,35 x 45°	●
AFV62342-120C	12	12	11,0	26	38	83	0,35 x 45°	●
AFV62342-120D	12	12	11,0	16	64	117	0,35 x 45°	●
AFV62342-160A	16	16	15,0	22	38	92	0,4 x 45°	●
AFV62342-160B	16	16	15,0	32	44	92	0,4 x 45°	●
AFV62342-160C	16	16	15,0	22	55	109	0,4 x 45°	●
AFV62342-160D	16	16	15,0	22	87	141	0,4 x 45°	●
AFV62342-200A	20	20	19,0	26	50	104	0,5 x 45°	●

AFV

Solid carbide end-mill with unequal pitch  
 Fraise carbure monobloc à tige - à pas inégal

mit freigeschliffenem Schaft / with extended neck / avec tige affûtée

								PG 24 268 - 275 beschichtet coated revêtu
Schaft DIN 6535HB Shank Tige	d -0,03	d <sub>a</sub> h6	d <sub>3</sub>	l <sub>1</sub>	l <sub>2</sub>	l	Fase / Chamfer	S100
AFV62342-200B	20	20	19,0	38	54	104	0,5 x 45°	●
AFV62342-200C	20	20	19,0	26	70	124	0,5 x 45°	●
AFV62342-200D	20	20	19,0	26	110	164	0,5 x 45°	●

P	●
M	●
K	●
N	
S	●
H	

● **Hauptanwendung**  
 Main application  
 Application principale

○ **Nebenanwendung**  
 Secondary application  
 Application secondaire

Solid carbide end-mill with unequal pitch  
 Fraise carbure monobloc à tige - à pas inégal

## AFV62342-...R...

4 Schneiden, kurze Ausführung, mit Eckenradius / 4 flutes, short design, with corner radius / 4 dents, version courte avec rayon d'angle

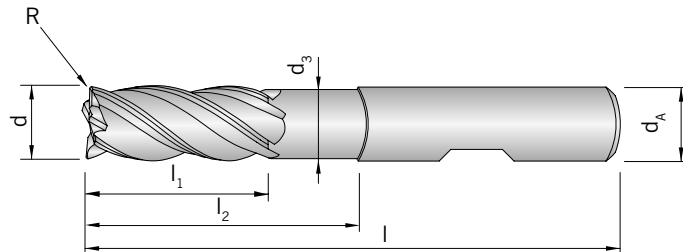
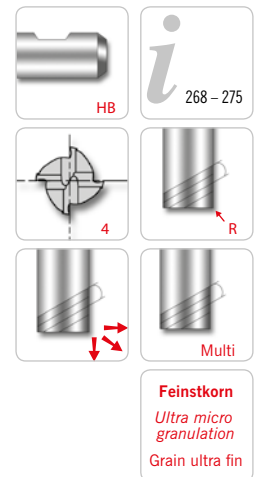

mit freigeschliffenem Schaft / with extended neck / avec tige affûtée

									PG 24
									beschichtet coated revêtu
Schaft DIN 6535HB Shank Tige	d -0,03	d <sub>A</sub> h6	d <sub>3</sub>	l <sub>1</sub>	l <sub>2</sub>	l	R	S100	
AFV62342-030AR0,3	3	6	2,7	7	12	54	0,3	●	
AFV62342-030AR0,5	3	6	2,7	7	12	54	0,5	●	
AFV62342-030BR0,3	3	6	2,7	7	17	57	0,3	●	
AFV62342-030BR0,5	3	6	2,7	7	17	57	0,5	●	
AFV62342-040AR0,3	4	6	3,7	8	15	57	0,3	●	
AFV62342-040AR0,5	4	6	3,7	8	15	57	0,5	●	
AFV62342-040BR0,3	4	6	3,7	8	22	63	0,3	●	
AFV62342-040BR0,5	4	6	3,7	8	22	63	0,5	●	
AFV62342-050AR0,3	5	6	4,7	10	17	57	0,3	●	
AFV62342-050AR0,5	5	6	4,7	10	17	57	0,5	●	
AFV62342-050BR0,3	5	6	4,7	10	27	67	0,3	●	
AFV62342-050BR0,5	5	6	4,7	10	27	67	0,5	●	
AFV62342-060AR0,3	6	6	5,5	10	15	57	0,3	●	
AFV62342-060AR0,5	6	6	5,5	10	15	57	0,5	●	
AFV62342-060AR1,0	6	6	5,5	10	15	57	1,0	●	
AFV62342-060BR0,3	6	6	5,5	10	20	62	0,3	●	
AFV62342-060BR0,5	6	6	5,5	10	20	62	0,5	●	
AFV62342-060BR1,0	6	6	5,5	10	20	62	1,0	●	
AFV62342-060CR0,3	6	6	5,5	10	32	74	0,3	●	
AFV62342-060CR0,5	6	6	5,5	10	32	74	0,5	●	
AFV62342-060CR1,0	6	6	5,5	10	32	74	1,0	●	
AFV62342-080AR0,5	8	8	7,5	12	20	63	0,5	●	
AFV62342-080AR1,0	8	8	7,5	12	20	63	1,0	●	
AFV62342-080BR0,5	8	8	7,5	12	30	73	0,5	●	
AFV62342-080BR1,0	8	8	7,5	12	30	73	1,0	●	
AFV62342-080CR0,5	8	8	7,5	12	46	90	0,5	●	
AFV62342-080CR1,0	8	8	7,5	12	46	90	1,0	●	
AFV62342-100AR0,5	10	10	9,2	14	25	72	0,5	●	
AFV62342-100AR1,0	10	10	9,2	14	25	72	1,0	●	
AFV62342-100BR0,5	10	10	9,2	14	35	82	0,5	●	
AFV62342-100BR1,0	10	10	9,2	14	35	82	1,0	●	

AFV

Solid carbide end-mill with unequal pitch  
Fraise carbure monobloc à tige - à pas inégal

mit freigeschliffenem Schaft / with extended neck / avec tige affûtée

								PG 24
								268 - 275 beschichtet coated revêtu
Schaft DIN 6535HB Shank Tige	d -0,03	d <sub>s</sub> h6	d <sub>3</sub>	l <sub>1</sub>	l <sub>2</sub>	l	R	S100
AFV62342-100CR0,5	10	10	9,2	14	55	102	0,5	●
AFV62342-100CR1,0	10	10	9,2	14	55	102	1,0	●
AFV62342-120AR0,5	12	12	11,0	16	30	83	0,5	●
AFV62342-120AR1,0	12	12	11,0	16	30	83	1,0	●
AFV62342-120AR2,0	12	12	11,0	16	30	83	2,0	●
AFV62342-120BR0,5	12	12	11,0	16	40	93	0,5	●
AFV62342-120BR1,0	12	12	11,0	16	40	93	1,0	●
AFV62342-120BR2,0	12	12	11,0	16	40	93	2,0	●
AFV62342-120CR0,5	12	12	11,0	16	64	117	0,5	●
AFV62342-120CR1,0	12	12	11,0	16	64	117	1,0	●
AFV62342-120CR2,0	12	12	11,0	16	64	117	2,0	●
AFV62342-160AR1,0	16	16	15,0	22	38	92	1,0	●
AFV62342-160AR2,0	16	16	15,0	22	38	92	2,0	●
AFV62342-160AR3,0	16	16	15,0	22	38	92	3,0	●
AFV62342-160BR1,0	16	16	15,0	22	55	109	1,0	●
AFV62342-160BR2,0	16	16	15,0	22	55	109	2,0	●
AFV62342-160BR3,0	16	16	15,0	22	55	109	3,0	●
AFV62342-160CR1,0	16	16	15,0	22	87	141	1,0	●
AFV62342-160CR2,0	16	16	15,0	22	87	141	2,0	●
AFV62342-160CR3,0	16	16	15,0	22	87	141	3,0	●
AFV62342-200AR1,0	20	20	19,0	26	50	104	1,0	●
AFV62342-200AR2,0	20	20	19,0	26	50	104	2,0	●
AFV62342-200AR3,0	20	20	19,0	26	50	104	3,0	●
AFV62342-200BR1,0	20	20	19,0	26	70	124	1,0	●
AFV62342-200BR2,0	20	20	19,0	26	70	124	2,0	●
AFV62342-200BR3,0	20	20	19,0	26	70	124	3,0	●
AFV62342-200CR1,0	20	20	19,0	26	110	164	1,0	●
AFV62342-200CR2,0	20	20	19,0	26	110	164	2,0	●
AFV62342-200CR3,0	20	20	19,0	26	110	164	3,0	●

P	●
M	●
K	●
N	
S	●
H	

● **Hauptanwendung**  
Main application  
Application principale

○ **Nebenanwendung**  
Secondary application  
Application secondaire

AFV

Solid carbide end-mill with unequal pitch  
Fraise carbure monobloc à tige - à pas inégal

## AFV61841-...

4 Schneiden, lange Ausführung / 4 flutes, long design / 4 dents, version longue

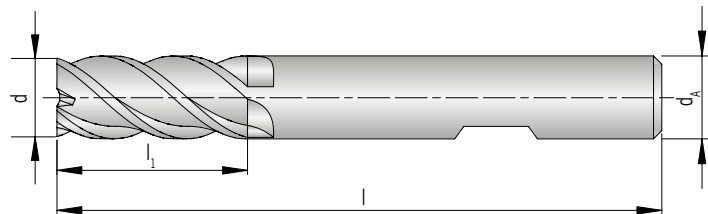
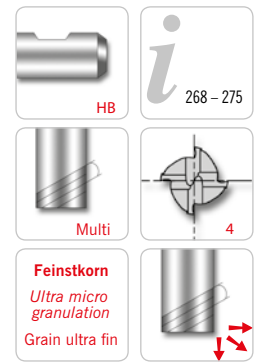

							PG 24
							beschichtet coated revêtu
Schaft DIN 6535HB Shank Tige	d -0,03	d <sub>A</sub> h6	l <sub>1</sub>	l	Fase / Chamfer	0100	
AFV61841-030	3	6	8	57	0,1 x 45°	●	
AFV61841-040	4	6	11	57	0,15 x 45°	●	
AFV61841-050	5	6	13	57	0,15 x 45°	●	
AFV61841-060	6	6	13	57	0,2 x 45°	●	
AFV61841-080	8	8	19	63	0,2 x 45°	●	
AFV61841-100	10	10	22	72	0,3 x 45°	●	
AFV61841-120	12	12	26	83	0,35 x 45°	●	
AFV61841-140	14	14	26	83	0,4 x 45°	●	
AFV61841-160	16	16	32	92	0,4 x 45°	●	
AFV61841-180	18	18	32	92	0,5 x 45°	●	
AFV61841-200	20	20	38	104	0,5 x 45°	●	
AFV61841-250	25	25	38	104	0,5 x 45°	●	

P	●
M	●
K	●
N	
S	●
H	

● **Hauptanwendung**  
Main application  
Application principale

○ **Nebenanwendung**  
Secondary application  
Application secondaire

AFV



Solid carbide end-mill with unequal pitch  
Fraise carbure monobloc à tige - à pas inégal

## AFV61841-...

4 Schneiden, lange Ausführung / 4 flutes, long design / 4 dents, version longue

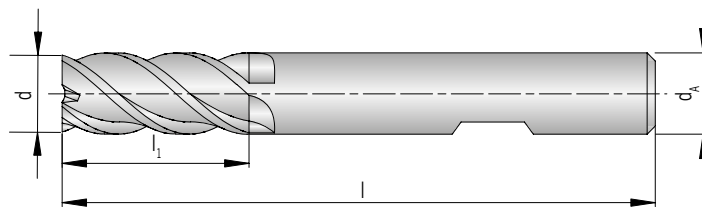

						PG 24
						beschichtet coated revêtu
Schaft DIN 6535HB Shank Tige	d -0,03	d <sub>A</sub> h6	l <sub>1</sub>	l	TiAlN	
AFV61841-030	3	6	8	57	●	
AFV61841-040	4	6	11	57	●	
AFV61841-050	5	6	13	57	●	
AFV61841-060	6	6	13	57	●	
AFV61841-080	8	8	19	63	●	
AFV61841-100	10	10	22	72	●	
AFV61841-120	12	12	26	83	●	
AFV61841-140	14	14	26	83	●	
AFV61841-160	16	16	32	92	●	
AFV61841-180	18	18	32	92	●	
AFV61841-200	20	20	38	104	●	
AFV61841-250	25	25	38	104	●	

P	○
M	●
K	○
N	
S	○
H	

● **Hauptanwendung**  
Main application  
Application principale

○ **Nebenanwendung**  
Secondary application  
Application secondaire

Solid carbide end-mill with unequal pitch  
Fraise carbure monobloc à tige - à pas inégal

## AFV61841-...R...

4 Schneiden, lange Ausführung / 4 flutes, long design / 4 dents, version longue

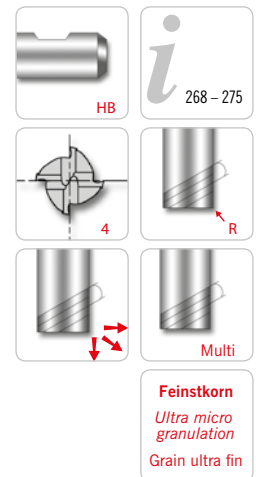
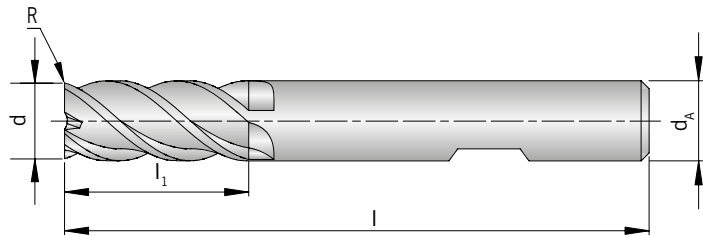

							PG 24
							beschichtet coated revêtu
Schaft DIN 6535HB Shank Tige	d -0,03	d <sub>A</sub> h6	l <sub>1</sub>	l	R	0105	
AFV61841-030R0,3	3	6	8	57	0,3	●	
AFV61841-030R0,5	3	6	8	57	0,5	●	
AFV61841-040R0,3	4	6	11	57	0,3	●	
AFV61841-040R0,5	4	6	11	57	0,5	●	
AFV61841-050R0,3	5	6	13	57	0,3	●	
AFV61841-050R0,5	5	6	13	57	0,5	●	
AFV61841-060R0,3	6	6	13	57	0,3	●	
AFV61841-060R0,5	6	6	13	57	0,5	●	
AFV61841-060R1,0	6	6	13	57	1,0	●	
AFV61841-080R0,5	8	8	19	63	0,5	●	
AFV61841-080R1,0	8	8	19	63	1,0	●	
AFV61841-100R0,5	10	10	22	72	0,5	●	
AFV61841-100R1,0	10	10	22	72	1,0	●	
AFV61841-120R0,5	12	12	26	83	0,5	●	
AFV61841-120R1,0	12	12	26	83	1,0	●	
AFV61841-120R2,0	12	12	26	83	2,0	●	
AFV61841-140R0,5	14	14	26	83	0,5	●	
AFV61841-160R1,0	16	16	32	92	1,0	●	
AFV61841-160R2,0	16	16	32	92	2,0	●	
AFV61841-160R3,0	16	16	32	92	3,0	●	
AFV61841-180R1,0	18	18	32	92	1,0	●	
AFV61841-200R1,0	20	20	38	104	1,0	●	
AFV61841-200R2,0	20	20	38	104	2,0	●	
AFV61841-200R3,0	20	20	38	104	3,0	●	
AFV61841-250R1,0	25	25	38	104	1,0	●	

● Hauptanwendung Main application Application principale	P	●
	M	●
	K	●
	N	●
○ Nebenanwendung Secondary application Application secondaire	S	●
	H	●

AFV

Solid carbide ball-nose end-mill with unequal pitch  
 Fraise carbure monobloc hémisphérique- à pas inégal

## AFV61841-...R...

4 Schneiden, lange Ausführung / 4 flutes, long design / 4 dents, version longue

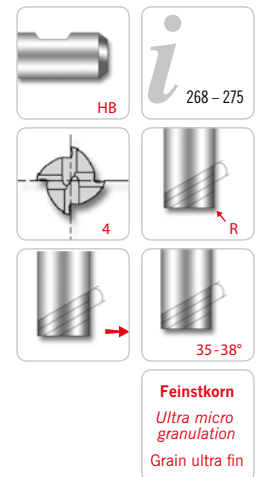
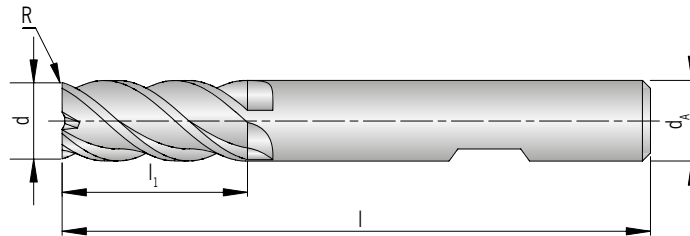

							PG 24
							beschichtet coated revêtu
Schaft DIN 6535HB Shank Tige	d -0,03	d <sub>A</sub> h6	l <sub>1</sub>	l	R ± 0,03	TiAIN	
AFV61841-030R0,3	3	6	8	57	0,3	●	
AFV61841-040R0,3	4	6	11	57	0,3	●	
AFV61841-050R0,3	5	6	13	57	0,3	●	
AFV61841-060R0,5	6	6	13	57	0,5	●	
AFV61841-080R0,5	8	8	19	63	0,5	●	
AFV61841-100R0,5	10	10	22	72	0,5	●	
AFV61841-100R1,5	10	10	22	72	1,5	●	
AFV61841-100R3,0	10	10	22	72	3,0	●	
AFV61841-120R0,7	12	12	26	83	0,7	●	
AFV61841-140R0,7	14	14	26	83	0,7	●	
AFV61841-160R1,0	16	16	32	92	1,0	●	
AFV61841-160R1,5	16	16	32	92	1,5	●	
AFV61841-160R2,0	16	16	32	92	2,0	●	
AFV61841-160R3,0	16	16	32	92	3,0	●	
AFV61841-180R1,0	18	18	32	92	1,0	●	
AFV61841-200R1,0	20	20	38	104	1,0	●	
AFV61841-200R2,0	20	20	38	104	2,0	●	
AFV61841-200R3,0	20	20	38	104	3,0	●	
AFV61841-250R1,0	25	25	38	104	1,0	●	
AFV61841-250R3,0	25	25	38	104	3,0	●	

P	○
M	●
K	○
N	○
S	○
H	○

● Hauptanwendung  
Main application  
Application principale  
○ Nebenanwendung  
Secondary application  
Application secondaire

Solid carbide ball-nose end-mill with unequal pitch  
 Fraise carbure monobloc hémisphérique- à pas inégal

## AFV60341-...

4 Schneiden, lange Ausführung / 4 flutes, long design / 4 dents, version longue

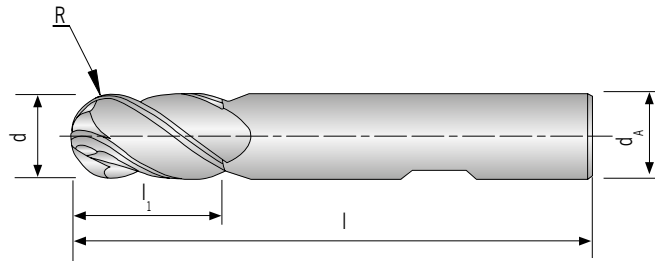

							PG 24
							beschichtet coated revêtu
Schaft DIN 6535HB Shank Tige	d -0,03	d <sub>A</sub> h6	l <sub>1</sub>	l	R ± 0,01	TiAIN	
AFV60341-030	3	6	8	57	3,0	●	
AFV60341-040	4	6	11	57	3,0	●	
AFV60341-050	5	6	13	57	3,0	●	
AFV60341-060	6	6	13	57	3,0	●	
AFV60341-080	8	8	19	63	4,0	●	
AFV60341-100	10	10	22	72	5,0	●	
AFV60341-120	12	12	26	83	6,0	●	
AFV60341-160	16	16	32	92	8,0	●	
AFV60341-200	20	20	38	104	10,0	●	
AFV60341-250	25	25	38	104	12,5	●	

P	○
M	●
K	○
N	○
S	○
H	○

● **Hauptanwendung**  
Main application  
Application principale

○ **Nebenanwendung**  
Secondary application  
Application secondaire

AFV

Solid carbide ball-nose end-mill with unequal pitch  
 Fraise carbure monobloc hémisphérique- à pas inégal

## AFV61646-...

4 Schneiden, lange Ausführung / 4 flutes, long design / 4 dents, version longue

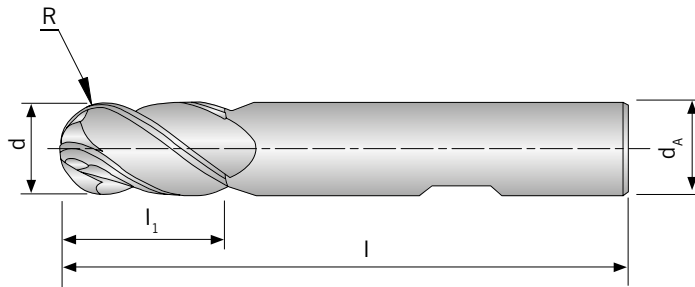

							PG 24
							beschichtet coated revêtu
Schaft DIN 6535HB Shank Tige	d -0,03	d <sub>A</sub> h6	l <sub>1</sub>	l	R ± 0,02	SI100	
AFV61646-030	3	6	8	57	1,5	●	
AFV61646-040	4	6	11	57	2,0	●	
AFV61646-050	5	6	13	57	2,5	●	
AFV61646-060	6	6	13	57	3,0	●	
AFV61646-080	8	8	19	63	4,0	●	
AFV61646-100	10	10	22	72	5,0	●	
AFV61646-120	12	12	26	83	6,0	●	
AFV61646-160	16	16	32	92	8,0	●	
AFV61646-200	20	20	38	104	10,0	●	
AFV61646-250	25	25	38	104	12,5	●	

P	●
M	●
K	●
N	○
S	○
H	○

● Hauptanwendung  
Main application  
Application principale

○ Nebenanwendung  
Secondary application  
Application secondaire

Solid carbide end-mill with unequal pitch  
 Fraise carbure monobloc à tige - à pas inégal

## AFV61851-...

5 Schneiden, lange Ausführung / 5 flutes, long design / 5 dents, version longue

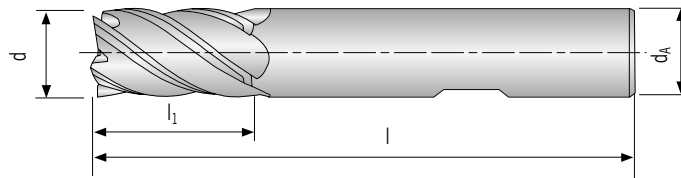

						PG 24
						beschichtet coated revêtu
Schaft DIN 6535HB Shank Tige	d -0,03	d <sub>A</sub> h6	l <sub>1</sub>	l	TiAlN	
AFV61851-060	6	6	13	57	●	
AFV61851-080	8	8	19	63	●	
AFV61851-100	10	10	22	72	●	
AFV61851-120	12	12	26	83	●	
AFV61851-140	14	14	26	83	●	
AFV61851-160	16	16	32	92	●	
AFV61851-180	18	18	32	92	●	
AFV61851-200	20	20	38	104	●	
AFV61851-250	25	25	38	104	●	

P	○
M	●
K	○
N	○
S	○
H	○

● **Hauptanwendung**  
Main application  
Application principale

○ **Nebenanwendung**  
Secondary application  
Application secondaire

AFV

Solid carbide end-mill  
Fraise carbure monobloc à tige

## AFV60266-...

6 Schneiden, lange Ausführung / 6 flutes, long design / 6 dents, version longue

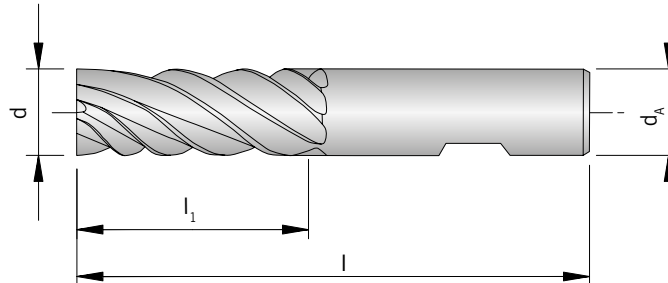

					PG 24
					beschichtet coated revêtu
Schaft DIN 6535HB Shank Tige	d -0,03	d <sub>A</sub> h6	l <sub>1</sub>	l	010S
AFV60266-060	6	6	13	57	●
AFV60266-080	8	8	19	63	●
AFV60266-100	10	10	22	72	●
AFV60266-120	12	12	26	83	●
AFV60266-160	16	16	32	92	●
AFV60266-200	20	20	38	104	●
AFV60266-250	25	25	44	104	●

P	●
M	●
K	●
N	●
S	●
H	

● **Hauptanwendung**  
Main application  
Application principale

○ **Nebenanwendung**  
Secondary application  
Application secondaire

AFV

Solid carbide end-mill

Fraise carbure monobloc à tige

## AFV60262-...

**6 Schneiden, extra lange Ausführung** / 6 flutes, extra long design / 6 dents, version extra longue

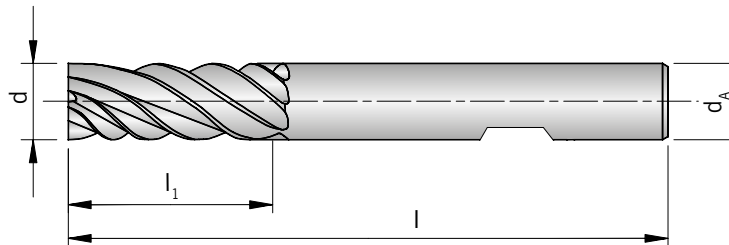

						PG 24
						beschichtet coated revêtu
Schaft DIN 6535HB Shank Tige	d -0,03	d <sub>A</sub> h6	l <sub>1</sub>	l	S100	
AFV60262-060	6	6	24	75	●	
AFV60262-080	8	8	32	75	●	
AFV60262-100	10	10	40	100	●	
AFV60262-120	12	12	48	120	●	
AFV60262-160	16	16	64	140	●	
AFV60262-200	20	20	80	150	●	
AFV60262-250	25	25	100	170	●	

P	●
M	●
K	●
N	●
S	●
H	

● **Hauptanwendung**  
Main application  
Application principale

○ **Nebenanwendung**  
Secondary application  
Application secondaire



## AFV60861-...R...

6 Schneiden, lange Ausführung, mit Eckenradius / 6 flutes, long design, with corner radius / 6 tranchants, design long, avec rayon d'angle

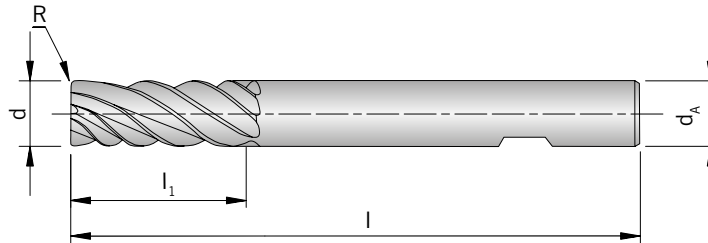
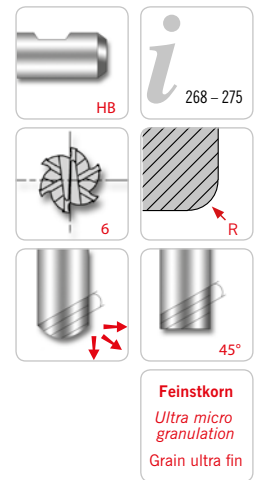

							PG 24
							beschichtet coated revêtu
Schaft DIN 6535HA Shank Tige	d -0,03	d <sub>A</sub> h6	l <sub>1</sub>	l	R	S100	
AFV60861-060R0,5	6	6	13	57	0,5	●	
AFV60861-060R1,0	6	6	13	57	1,0	●	
AFV60861-080R0,5	8	8	19	63	0,5	●	
AFV60861-080R1,0	8	8	19	63	1,0	●	
AFV60861-100R0,5	10	10	22	72	0,5	●	
AFV60861-100R1,0	10	10	22	72	1,0	●	
AFV60861-100R1,5	10	10	22	72	1,5	●	
AFV60861-100R2,0	10	10	22	72	2,0	●	
AFV60861-120R0,5	12	12	26	83	0,5	●	
AFV60861-120R1,0	12	12	26	83	1,0	●	
AFV60861-120R1,5	12	12	26	83	1,5	●	
AFV60861-120R2,0	12	12	26	83	2,0	●	
AFV60861-120R3,0	12	12	26	83	3,0	●	
AFV60861-160R1,0	16	16	32	92	1,0	●	
AFV60861-160R1,5	16	16	32	92	1,5	●	
AFV60861-160R2,0	16	16	32	92	2,0	●	
AFV60861-160R3,0	16	16	32	92	3,0	●	
AFV60861-200R1,0	20	20	38	104	1,0	●	
AFV60861-200R1,5	20	20	38	104	1,5	●	
AFV60861-200R2,0	20	20	38	104	2,0	●	
AFV60861-200R3,0	20	20	38	104	3,0	●	
AFV60861-250R1,0	25	25	44	104	1,0	●	
AFV60861-250R1,5	25	25	44	104	1,5	●	
AFV60861-250R2,0	25	25	44	104	2,0	●	
AFV60861-250R3,0	25	25	44	104	3,0	●	

● Hauptanwendung Main application Application principale	P	●
	M	●
	K	●
	N	●
○ Nebenanwendung Secondary application Application secondaire	S	●
	H	

## AFV60862-...R...

**6 Schneiden, extra lange Ausführung, mit Eckenradius / 6 flutes, extra long design, with corner radius / 6 dents, version extra longue, avec rayon d'angle**

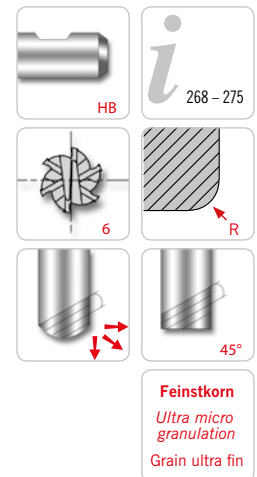
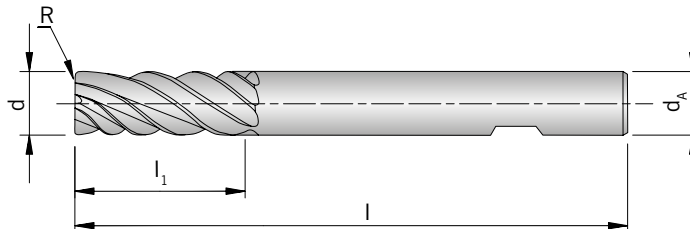

							PG 24
							beschichtet coated revêtu
Schaft DIN 6535HA Shank Tige	d -0,03	d <sub>A</sub> h6	l <sub>1</sub>	l	R	S100	
AFV60862-060R0,5	6	6	24	75	0,5	●	
AFV60862-060R1,0	6	6	24	75	1,0	●	
AFV60862-080R0,5	8	8	32	75	0,5	●	
AFV60862-080R1,0	8	8	32	75	1,0	●	
AFV60862-080R2,0	8	8	32	75	2,0	●	
AFV60862-100R0,5	10	10	40	100	0,5	●	
AFV60862-100R1,0	10	10	40	100	1,0	●	
AFV60862-100R1,5	10	10	40	100	1,5	●	
AFV60862-100R2,0	10	10	40	100	2,0	●	
AFV60862-120R0,5	12	12	48	120	0,5	●	
AFV60862-120R1,0	12	12	48	120	1,0	●	
AFV60862-120R1,5	12	12	48	120	1,5	●	
AFV60862-120R2,0	12	12	48	120	2,0	●	
AFV60862-120R3,0	12	12	48	120	3,0	●	
AFV60862-160R1,0	16	16	64	140	1,0	●	
AFV60862-160R1,5	16	16	64	140	1,5	●	
AFV60862-160R2,0	16	16	64	140	2,0	●	
AFV60862-160R3,0	16	16	64	140	3,0	●	
AFV60862-200R1,0	20	20	80	150	1,0	●	
AFV60862-200R1,5	20	20	80	150	1,5	●	
AFV60862-200R2,0	20	20	80	150	2,0	●	
AFV60862-200R3,0	20	20	80	150	3,0	●	
AFV60862-200R4,0	20	20	80	150	4,0	●	
AFV60862-200R5,0	20	20	80	150	5,0	●	
AFV60862-250R1,0	25	25	100	170	1,0	●	
AFV60862-250R1,5	25	25	100	170	1,5	●	
AFV60862-250R2,0	25	25	100	170	2,0	●	

AFV

Solid carbide end-mill

Fraise carbure monobloc à tige

							PG 24
							beschichtet coated revêtu
Schaft DIN 6535HA Shank Tige	d -0,03	d <sub>A</sub> h6	l <sub>1</sub>	l	R	§100	
AFV60862-250R3,0	25	25	100	170	3,0	●	
AFV60862-250R4,0	25	25	100	170	4,0	●	
AFV60862-250R5,0	25	25	100	170	5,0	●	

P	●
M	●
K	●
N	
S	●
H	

- **Hauptanwendung**  
Main application  
Application principale
- **Nebenanwendung**  
Secondary application  
Application secondaire

Werkstoffgruppe	Gliederung der Werkstoffhauptgruppen und Kennbuchstaben		Brinell-Härte	Zugfestigkeit Rm (N/mm <sup>2</sup> )	Zerspanungsgruppe	Korrekturfaktor	Schnittgeschwindigkeit V <sub>c</sub> (m/min)	
							VHM S100	VHM TiCN
P	Unlegierter Stahl	C ≤ 0,25 % geglüht	125	428	P1	1,2	110 - 185 - 260	100 - 170 - 240
		C > 0,25 ... ≤ 0,55 % geglüht	190	639	P2	1,2	110 - 185 - 260	100 - 170 - 240
		C > 0,25 ... ≤ 0,55 % vergütet	210	708	P3	1,2	100 - 180 - 260	90 - 155 - 220
		C > 0,55 % geglüht	190	639	P4	1,2	110 - 185 - 260	100 - 170 - 240
		C > 0,55 % vergütet	300	1013	P5	1,0	65 - 108 - 150	60 - 100 - 140
	Niedrig legierter Stahl	Automatenstahl (kurzspanend) geglüht	220	745	P6	1,2	110 - 185 - 260	100 - 170 - 240
		geglüht	175	591	P7	1,2	100 - 160 - 220	90 - 145 - 200
		vergütet	300	1013	P8	1,0	100 - 160 - 220	90 - 145 - 200
		vergütet	380	1282	P9	0,8	65 - 98 - 130	60 - 90 - 120
		vergütet	430	1477	P10	0,8	65 - 98 - 130	60 - 90 - 120
Hochlegierter Stahl und hochlegierter Werkzeugstahl	geglüht	200	675	P11	1,2	100 - 160 - 220	90 - 145 - 200	
	gehärtet und angelassen	300	1013	P12	1,0	90 - 120 - 150	80 - 110 - 140	
	gehärtet und angelassen	400	1361	P13	0,8	65 - 93 - 120	60 - 85 - 110	
Nichtrostender Stahl	ferritisch / martensitisch, geglüht	200	675	P14	1,0	55 - 93 - 130	50 - 85 - 120	
	martensitisch, vergütet	330	1114	P15	0,9	35 - 63 - 90	30 - 55 - 80	
M	Nichtrostender Stahl	austenitisch, abgeschreckt	200	675	M1	1,0	65 - 98 - 130	60 - 90 - 120
		austenitisch, ausscheidungsgehärtet (PH)	300	1013	M2	0,9	35 - 63 - 90	30 - 55 - 80
		austenitisch-ferritisch, Duplex	230	778	M3	1,0	55 - 93 - 130	50 - 85 - 120
K	Temperguss	ferritisch	200	675	K1	1,0	90 - 135 - 180	80 - 120 - 160
		perrlitisch	260	867	K2	0,8	80 - 125 - 170	70 - 110 - 150
	Grauguss	niedrige Festigkeit	180	602	K3	1,0	90 - 135 - 180	80 - 120 - 160
		hohe Festigkeit / austenitisch	245	825	K4	1,0	80 - 135 - 190	70 - 110 - 150
	Gusseisen mit Kugelgraphit	ferritisch	155	518	K5	1,0	90 - 145 - 200	80 - 120 - 160
		perrlitisch	265	885	K6	1,0	80 - 125 - 170	70 - 110 - 150
	GGV (CGI)		200	675	K7	1,0	90 - 145 - 200	80 - 120 - 160
N	Aluminium-Knetlegierungen	nicht aushärtbar	30	-	N1		-	-
		aushärtbar, ausgehärtet	100	343	N2		-	-
	Aluminium-Gusslegierungen	≤ 12 % Si, nicht aushärtbar	75	260	N3		-	-
		≤ 12 % Si, aushärtbar, ausgehärtet	90	314	N4		-	-
		> 12 % Si, nicht aushärtbar	130	447	N5		-	-
	Magnesiumlegierungen		70	250	N6		-	-
	Kupfer und Kupferlegierungen (Bronze / Messing)	unlegiert, Elektrolytkupfer	100	343	N7		-	-
		Messing, Bronze, Rotguss	90	314	N8		-	-
		Cu-Legierung, kurzspanend	110	382	N9		-	-
		hochfest, Ampco	300	1013	N10		-	-
	Nichtmetallische Werkstoffe	Thermoplaste (ohne abrasive Füllstoffe)	-	-	N11		-	-
		Duroplaste (ohne abrasive Füllstoffe)	-	-	N12		-	-
		Kunststoff glasfaserverstärkt GFRP	-	-	N13		-	-
		Kunststoff kohlefaserverstärkt CFRP	-	-	N14		-	-
		Kunststoff aramidfaserverstärkt AFRP	-	-	N15		-	-
		Graphit (technisch)	80 Shore	-	N16		-	-
S	Warmfeste Legierungen	Fe-Basis geglüht	200	675	S1	0,7	30 - 60 - 90	30 - 60 - 90
		ausgehärtet	280	943	S2	0,7	30 - 60 - 90	30 - 60 - 90
		geglüht	250	839	S3	0,9	30 - 50 - 70	30 - 50 - 70
		Ni- oder Co-Basis ausgehärtet	350	1177	S4	0,7	30 - 55 - 80	30 - 55 - 80
		gegossen	320	1076	S5	0,7	30 - 50 - 70	30 - 55 - 80
	Titanlegierungen	Reintitan	200	675	S6	1,0	50 - 85 - 120	50 - 85 - 120
		α- und β-Legierungen, ausgehärtet	375	1262	S7	1,0	40 - 75 - 110	40 - 75 - 110
		β-Legierungen	410	1396	S8	1,0	40 - 75 - 110	40 - 75 - 110
	Wolframlegierungen		300	1013	S9	1,1	-	-
	Molybdänlegierungen		300	1013	S10	1,0	-	-
H	Gehärteter Stahl	gehärtet und angelassen	50 HRC	-	H1		-	-
		gehärtet und angelassen	55 HRC	-	H2		-	-
		gehärtet und angelassen	60 HRC	-	H3		-	-
	Gehärtetes Gusseisen	gehärtet und angelassen	55 HRC	-	H4		-	-

Die Tabellenwerte sind Richtwerte. Es kann notwendig sein, die Werte den jeweiligen Bearbeitungsumständen anzupassen.

Material group	Structure of the material groups and identification letters		Brinell hardness HB	Tensile strength Rm (N/mm <sup>2</sup> )	Chipping group	Correction factor	Cutting speed V <sub>c</sub> (m/min)		
							VHM S100	VHM TiCN	
P	Unalloyed steel	C ≤ 0.25 % annealed	125	428	P1	1,2	110 - 185 - 260	100 - 170 - 240	
		C > 0.25 ... ≤ 0.55 % annealed	190	639	P2	1,2	110 - 185 - 260	100 - 170 - 240	
		C > 0.25 ... ≤ 0.55 % hardened and tempered	210	708	P3	1,2	100 - 180 - 260	90 - 155 - 220	
		C > 0.55 % annealed	190	639	P4	1,2	110 - 185 - 260	100 - 170 - 240	
		C > 0.55 % hardened and tempered	300	1013	P5	1,0	65 - 108 - 150	60 - 100 - 140	
		Machining steel (short-chipping) tempered	220	745	P6	1,2	110 - 185 - 260	100 - 170 - 240	
	Low alloyed steel	annealed	175	591	P7	1,2	100 - 160 - 220	90 - 145 - 200	
		hardened and tempered	300	1013	P8	1,0	100 - 160 - 220	90 - 145 - 200	
		hardened and tempered	380	1282	P9	0,8	65 - 98 - 130	60 - 90 - 120	
		hardened and tempered	430	1477	P10	0,8	65 - 98 - 130	60 - 90 - 120	
	High alloyed steel and high alloyed tool steel	annealed	200	675	P11	1,2	100 - 160 - 220	90 - 145 - 200	
		hardened	300	1013	P12	1,0	90 - 120 - 150	80 - 110 - 140	
		hardened	400	1361	P13	0,8	65 - 93 - 120	60 - 85 - 110	
	Stainless steel	ferritic / martensitic, annealed	200	675	P14	1,0	55 - 93 - 130	50 - 85 - 120	
		martensitic, hardened and tempered	330	1114	P15	0,9	35 - 63 - 90	30 - 55 - 80	
austenitic, chilled		200	675	M1	1,0	65 - 98 - 130	60 - 90 - 120		
M	Stainless steel	austenitic, precipitation-hardened (PH)	300	1013	M2	0,9	35 - 63 - 90	30 - 55 - 80	
		austenitic-ferritic, Duplex	230	778	M3	1,0	55 - 93 - 130	50 - 85 - 120	
		ferritic	200	675	K1	1,0	90 - 135 - 180	80 - 120 - 160	
K	Malleable cast iron	pearlitic	260	867	K2	0,8	80 - 125 - 170	70 - 110 - 150	
		low tensile strength	180	602	K3	1,0	90 - 135 - 180	80 - 120 - 160	
	Cast iron	high tensile strength / austenitic	245	825	K4	1,0	80 - 135 - 190	70 - 110 - 150	
		ferritic	155	518	K5	1,0	90 - 145 - 200	80 - 120 - 160	
	Cast iron with nodular graphite	pearlitic	265	885	K6	1,0	80 - 125 - 170	70 - 110 - 150	
		GGV (CGI)	200	675	K7	1,0	90 - 145 - 200	80 - 120 - 160	
N	Aluminium alloys long chipping	not heat treatable	30	-	N1		-	-	
		heat treatable, heat treated	100	343	N2		-	-	
	Casted aluminium alloys	≤ 12 % Si, not heat treatable	75	260	N3		-	-	
		≤ 12 % Si, aushärtbar, ausgehärtet	90	314	N4		-	-	
		> 12 % Si, not heat treatable	130	447	N5		-	-	
	Magnesium alloys		70	250	N6		-	-	
	Copper and copper alloys (Brass / Bronze)	Unalloyed, elektrolyte copper	100	343	N7		-	-	
		Brass, Bronze	90	314	N8		-	-	
		Cu-alloys, short-chipping	110	382	N9		-	-	
		High-tensile, Ampco	300	1013	N10		-	-	
	Non-ferrous materials	Lead alloys (without abrasive filling material)	-	-	N11		-	-	
		Duroplastic (without abrasive filling material)	-	-	N12		-	-	
		Plastic glas fibre reinforced GFRP	-	-	N13		-	-	
		Plastic carbon fibre reinforced CFRP	-	-	N14		-	-	
		Plastic aramid fibre reinforced AFRP	-	-	N15		-	-	
		Graphite (tech.)	80 Shore	-	N16		-	-	
S	High temperature resistant alloys	Fe-Basis	annealed	200	675	S1	0,7	30 - 60 - 90	30 - 60 - 90
			heat treated	280	943	S2	0,7	30 - 60 - 90	30 - 60 - 90
		Ni- or Co-alloyed	annealed	250	839	S3	0,9	30 - 50 - 70	30 - 50 - 70
			heat treated	350	1177	S4	0,7	30 - 55 - 80	30 - 55 - 80
			casting	320	1076	S5	0,7	30 - 50 - 70	30 - 55 - 80
	Titanium alloys	Pure titan	200	675	S6	1,0	50 - 85 - 120	50 - 85 - 120	
		α- and β-alloys, heat treated	375	1262	S7	1,0	40 - 75 - 110	40 - 75 - 110	
		β-alloys	410	1396	S8	1,0	40 - 75 - 110	40 - 75 - 110	
	Wolfram alloys		300	1013	S9	1,1	-	-	
	Molybdän alloys		300	1013	S10	1,0	-	-	
H	Hardened steel	hardened	50 HRC	-	H1		-	-	
		hardened	55 HRC	-	H2		-	-	
		hardened	60 HRC	-	H3		-	-	
	Hardened cast iron	hardened	55 HRC	-	H4		-	-	

The recommended cutting data are only approximate values. It may be necessary to adjust them to each individual machining application.

ISO	Matériaux	Dureté Brinell	Résistance (N/mm <sup>2</sup> )	Groupe d'usinage	facteur de correction	Vitesse de coupe Vc (m/min)		
						VHM S100	VHM TiCN	
P	Acier non allié	C ≤ 0,25 % recuit	125	428	P1	1,2	110 - 185 - 260	100 - 170 - 240
		C > 0,25 ... ≤ 0,55 % recuit	190	639	P2	1,2	110 - 185 - 260	100 - 170 - 240
		C > 0,25 ... ≤ 0,55 % traité	210	708	P3	1,2	100 - 180 - 260	90 - 155 - 220
		C > 0,55 % recuit	190	639	P4	1,2	110 - 185 - 260	100 - 170 - 240
		C > 0,55 % traité	300	1013	P5	1,0	65 - 108 - 150	60 - 100 - 140
		Aciers de décolletage (à copeaux courts) recuit	220	745	P6	1,2	110 - 185 - 260	100 - 170 - 240
	Acier faiblement allié	recuit	175	591	P7	1,2	100 - 160 - 220	90 - 145 - 200
		traité	300	1013	P8	1,0	100 - 160 - 220	90 - 145 - 200
		traité	380	1282	P9	0,8	65 - 98 - 130	60 - 90 - 120
		traité	430	1477	P10	0,8	65 - 98 - 130	60 - 90 - 120
	Acier allié et acier outil allié	recuit	200	675	P11	1,2	100 - 160 - 220	90 - 145 - 200
		trempe et revenu	300	1013	P12	1,0	90 - 120 - 150	80 - 110 - 140
		trempe et revenu	400	1361	P13	0,8	65 - 93 - 120	60 - 85 - 110
	Acier inox	ferritique, martensitique, recuit	200	675	P14	1,0	55 - 93 - 130	50 - 85 - 120
		martensitique, traité	330	1114	P15	0,9	35 - 63 - 90	30 - 55 - 80
M	Acier inox	austénitique	200	675	M1	1,0	65 - 98 - 130	60 - 90 - 120
		austénitique	300	1013	M2	0,9	35 - 63 - 90	30 - 55 - 80
		austénitique-ferritique, Duplex	230	778	M3	1,0	55 - 93 - 130	50 - 85 - 120
K	Fonte malléable	ferritique	200	675	K1	1,0	90 - 135 - 180	80 - 120 - 160
		perlitique	260	867	K2	0,8	80 - 125 - 170	70 - 110 - 150
	Fonte grise	faible résistance	180	602	K3	1,0	90 - 135 - 180	80 - 120 - 160
		haute résistance / austénitique	245	825	K4	1,0	80 - 135 - 190	70 - 110 - 150
	Fonte à Graphite sphéroïdale	ferritique	155	518	K5	1,0	90 - 145 - 200	80 - 120 - 160
		perlitique	265	885	K6	1,0	80 - 125 - 170	70 - 110 - 150
GGV (CGI)		200	675	K7	1,0	90 - 145 - 200	80 - 120 - 160	
N	Alliages de fonderie d'aluminium	ne pouvant pas subir un durcissement	30	-	N1		-	-
		pouvant subir un durcissement, durci	100	343	N2		-	-
	Alliage de fonte d'aluminium	≤ 12 % Si, ne pouvant pas subir de durcissement	75	260	N3		-	-
		≤ 12 % Si, pouvant subir un durcissement, durci	90	314	N4		-	-
		> 12 % Si, ne pouvant pas subir de durcissement	130	447	N5		-	-
Alliage de Magnésium		70	250	N6		-	-	
Cuivre et alliage de cuivre (bronze / laiton)	non allié, cuivre électrolytique	100	343	N7		-	-	
	Laiton, bronze, fonte rouge	90	314	N8		-	-	
	Alliage de cuivre à copeaux courts	110	382	N9		-	-	
	forte résistance, Ampco	300	1013	N10		-	-	
Matériaux non métalliques	Thermoplaste (sans agents de charge abrasives)	-	-	N11		-	-	
	Duroplaste (sans agents de charge abrasives)	-	-	N12		-	-	
	Matière plastique renforcée de fibres de verre GFRP	-	-	N13		-	-	
	Matière plastique renforcé composite CFRP	-	-	N14		-	-	
	Plastique renforcé fibre aramide AFRP	-	-	N15		-	-	
	Graphite	80 Shore	-	N16		-	-	
S	Alliages réfractaires	à base de Fe recuit	200	675	S1	0,7	30 - 60 - 90	30 - 60 - 90
		à base de Fe durci	280	943	S2	0,7	30 - 60 - 90	30 - 60 - 90
		à base Ni ou Co recuit	250	839	S3	0,9	30 - 50 - 70	30 - 50 - 70
		à base Ni ou Co durci	350	1177	S4	0,7	30 - 55 - 80	30 - 55 - 80
		à base Ni ou Co jeter	320	1076	S5	0,7	30 - 50 - 70	30 - 55 - 80
	Alliage de titane	Titane pur	200	675	S6	1,0	50 - 85 - 120	50 - 85 - 120
		Alliages Alpha + Beta, trempé	375	1262	S7	1,0	40 - 75 - 110	40 - 75 - 110
		Alliages Beta	410	1396	S8	1,0	40 - 75 - 110	40 - 75 - 110
	Alliage de tungstène		300	1013	S9	1,1	-	-
	Alliage de molybdène		300	1013	S10	1,0	-	-
H	Acier trempé	trempe et revenu	50 HRC	-	H1		-	-
		trempe et revenu	55 HRC	-	H2		-	-
		trempe et revenu	60 HRC	-	H3		-	-
	Fonte durci	trempe et revenu	55 HRC	-	H4		-	-

Les valeurs du tableau sont indicatives. Il peut être nécessaire de les adapter aux conditions d'usinage respectives.

## Vorschub pro Zahn bei einer radialen Zustellung von 0,2 – 0,3 mm

Feed per tooth with radial depth of cut from 0,2 – 0,3 mm

Avance par dent avec un engagement radial de 0,2 – 0,3 mm

Ø d <sub>1</sub> [mm]	Korrekturfaktor / Correction factor / Facteur de correction									
	1	0,7	0,8	0,9	1,1	1,2	1,5	1,6	1,8	1,9
1	0,004	0,003	0,003	0,004	0,004	0,005	0,006	0,006	0,007	0,008
2	0,008	0,006	0,006	0,007	0,009	0,010	0,012	0,013	0,014	0,015
3	0,012	0,008	0,010	0,011	0,013	0,014	0,018	0,019	0,022	0,023
4	0,016	0,011	0,013	0,014	0,018	0,019	0,024	0,026	0,029	0,030
5	0,020	0,014	0,016	0,018	0,022	0,024	0,030	0,032	0,036	0,038
6	0,024	0,017	0,019	0,022	0,026	0,029	0,036	0,038	0,043	0,046
8	0,032	0,022	0,026	0,029	0,035	0,038	0,048	0,051	0,058	0,061
10	0,040	0,028	0,032	0,036	0,044	0,048	0,060	0,064	0,072	0,076
12	0,048	0,034	0,038	0,043	0,053	0,058	0,072	0,077	0,086	0,091
14	0,056	0,039	0,045	0,050	0,062	0,067	0,084	0,090	0,101	0,106
16	0,064	0,045	0,051	0,058	0,070	0,077	0,096	0,102	0,115	0,122
18	0,072	0,050	0,058	0,065	0,079	0,086	0,108	0,115	0,130	0,137
20	0,080	0,056	0,064	0,072	0,088	0,096	0,120	0,128	0,144	0,152
25	0,100	0,070	0,080	0,090	0,110	0,120	0,150	0,160	0,180	0,190

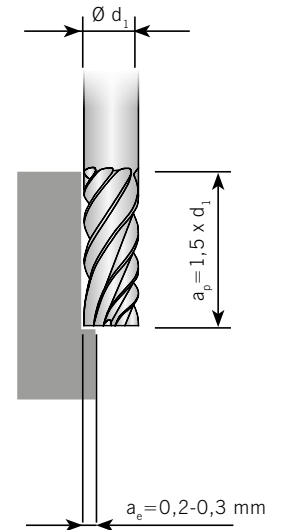

## Vorschub pro Zahn bei einer radialen Zustellung 10% vom Schneidendurchmesser (Ø d<sub>1</sub>)

Feed per tooth with radial depth of cut of 10% of the cutter (Ø d<sub>1</sub>)

Avance par dent avec un engagement radial de 10 % du diamètre de coupe (Ø d<sub>1</sub>)

Ø d <sub>1</sub> [mm]	Korrekturfaktor / Correction factor / Facteur de correction									
	1	0,7	0,8	0,9	1,1	1,2	1,5	1,6	1,8	1,9
1	0,003	0,002	0,002	0,003	0,003	0,004	0,005	0,005	0,005	0,006
2	0,008	0,006	0,006	0,007	0,009	0,010	0,012	0,013	0,014	0,015
3	0,012	0,008	0,010	0,011	0,013	0,014	0,018	0,019	0,022	0,023
4	0,014	0,010	0,011	0,013	0,015	0,017	0,021	0,022	0,025	0,027
5	0,017	0,012	0,014	0,015	0,019	0,020	0,026	0,027	0,031	0,032
6	0,020	0,014	0,016	0,018	0,022	0,024	0,030	0,032	0,036	0,038
8	0,027	0,019	0,022	0,024	0,030	0,032	0,041	0,043	0,049	0,051
10	0,033	0,023	0,026	0,030	0,036	0,040	0,050	0,053	0,059	0,063
12	0,040	0,028	0,032	0,036	0,044	0,048	0,060	0,064	0,072	0,076
14	0,047	0,033	0,038	0,042	0,052	0,056	0,071	0,075	0,085	0,089
16	0,053	0,037	0,042	0,048	0,058	0,064	0,080	0,085	0,095	0,101
18	0,060	0,042	0,048	0,054	0,066	0,072	0,090	0,096	0,108	0,114
20	0,067	0,047	0,054	0,060	0,074	0,080	0,101	0,107	0,121	0,127
25	0,083	0,058	0,066	0,075	0,091	0,100	0,125	0,133	0,149	0,158

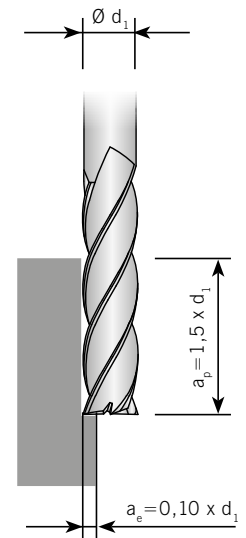

**Achtung:** Korrekturfaktor aus der Tabelle "Schnittgeschwindigkeiten" entnehmen.  
Korrekturfaktor -> 1,1 bei a<sub>p</sub> = 1 x d<sub>1</sub> -> 1,2 bei a<sub>p</sub> = 0,5 x d<sub>1</sub>

Attention: Take the correction factor from the table "Cutting speeds".  
Correction factor -> 1,1 with a<sub>p</sub> = 1 x d<sub>1</sub> -> 1,2 with a<sub>p</sub> = 0,5 x d<sub>1</sub>

Attention: Prenez le facteur de correction du tableau «Vitesses de coupe».  
Facteur de correction -> 1,1 pour a<sub>p</sub> = 1 x d<sub>1</sub> -> 1,2 pour a<sub>p</sub> = 0,5 x d<sub>1</sub>

## Vorschub pro Zahn bei einer radialen Zustellung 20% vom Schneidendurchmesser ( $\varnothing d_1$ )

Feed per tooth with radial depth of cut of 20% of the cutter ( $\varnothing d_1$ )

Avance par dent avec un engagement radial de 20% du diamètre de coupe ( $\varnothing d_1$ )

$\varnothing d_1$ [mm]	Korrekturfaktor / Correction factor / Facteur de correction									
	1	0,7	0,8	0,9	1,1	1,2	1,5	1,6	1,8	1,9
1	0,002	0,001	0,001	0,001	0,002	0,002	0,003	0,003	0,003	0,003
2	0,005	0,003	0,004	0,004	0,005	0,006	0,007	0,008	0,009	0,009
3	0,008	0,005	0,006	0,007	0,008	0,009	0,012	0,012	0,014	0,015
4	0,010	0,007	0,008	0,009	0,011	0,012	0,015	0,016	0,018	0,019
5	0,013	0,009	0,010	0,011	0,014	0,015	0,019	0,020	0,023	0,024
6	0,015	0,010	0,012	0,013	0,016	0,018	0,022	0,024	0,027	0,028
8	0,020	0,014	0,016	0,018	0,022	0,024	0,030	0,032	0,036	0,038
10	0,025	0,017	0,020	0,022	0,027	0,030	0,037	0,040	0,045	0,047
12	0,030	0,021	0,024	0,027	0,033	0,036	0,045	0,048	0,054	0,057
14	0,035	0,024	0,028	0,031	0,038	0,042	0,052	0,056	0,063	0,066
16	0,040	0,028	0,032	0,036	0,044	0,048	0,060	0,064	0,072	0,076
18	0,045	0,031	0,036	0,040	0,049	0,054	0,067	0,072	0,081	0,085
20	0,050	0,035	0,040	0,045	0,055	0,060	0,075	0,080	0,090	0,095
25	0,063	0,044	0,050	0,056	0,069	0,075	0,094	0,100	0,113	0,119

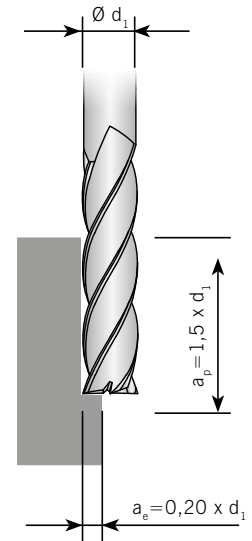

## Vorschub pro Zahn bei einer radialen Zustellung 40% vom Schneidendurchmesser ( $\varnothing d_1$ )

Feed per tooth with radial depth of cut of 40% of the cutter ( $\varnothing d_1$ )

Avance par dent avec un engagement radial de 40% du diamètre de coupe ( $\varnothing d_1$ )

$\varnothing d_1$ [mm]	Korrekturfaktor / Correction factor / Facteur de correction									
	1	0,7	0,8	0,9	1,1	1,2	1,5	1,6	1,8	1,9
1	0,001	0,001	0,001	0,001	0,001	0,001	0,002	0,002	0,002	0,003
2	0,004	0,002	0,003	0,003	0,004	0,004	0,006	0,006	0,007	0,007
3	0,006	0,004	0,005	0,005	0,007	0,007	0,009	0,010	0,011	0,012
4	0,008	0,005	0,006	0,007	0,008	0,009	0,012	0,012	0,014	0,015
5	0,010	0,007	0,008	0,009	0,011	0,012	0,015	0,016	0,018	0,019
6	0,012	0,008	0,009	0,010	0,013	0,014	0,018	0,019	0,021	0,022
8	0,016	0,011	0,012	0,014	0,017	0,019	0,024	0,025	0,028	0,030
10	0,020	0,014	0,016	0,018	0,022	0,024	0,030	0,032	0,036	0,038
12	0,024	0,016	0,019	0,021	0,026	0,028	0,036	0,038	0,043	0,045
14	0,028	0,019	0,022	0,025	0,030	0,033	0,042	0,044	0,050	0,053
16	0,032	0,022	0,025	0,028	0,035	0,038	0,048	0,051	0,057	0,060
18	0,036	0,025	0,028	0,032	0,039	0,043	0,054	0,057	0,064	0,068
20	0,040	0,028	0,032	0,036	0,044	0,048	0,060	0,064	0,072	0,076
25	0,050	0,035	0,040	0,045	0,055	0,060	0,075	0,080	0,090	0,095

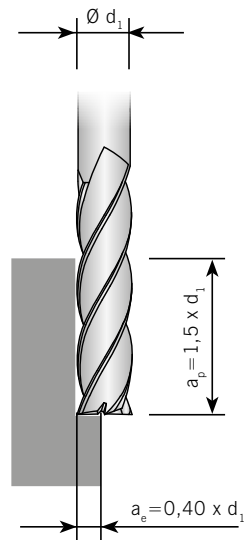

Achtung: Vorschub-Korrekturfaktor  $\rightarrow Kf_f = 1,10$  bei  $a_p = 1 \times d_1$  und  $\rightarrow Kf_f = 1,25$  bei  $a_p = 0,5 \times d_1$ . Für unbeschichtete Werkzeuge ist der Vorschub um 10-20% zu reduzieren.

Attention: Feed rate correction factor  $\rightarrow Kf_f = 1,10$  with  $a_p = 1 \times d_1$  and  $\rightarrow Kf_f = 1,25$  with  $a_p = 0,5 \times d_1$ . Feed rates are reduced by 10-20% for uncoated tools.

Attention: Facteur de correction d'avance  $\rightarrow Kf_f = 1,10$  pour  $a_p = 1 \times d_1$  et  $\rightarrow Kf_f = 1,25$  pour  $a_p = 0,5 \times d_1$ . Pour les outils sans revêtement, l'avance doit être réduite de 10 à 20%.



**Vorschub pro Zahn bei einer radialen Zustellung 60% vom Schneidendurchmesser ( $\varnothing d_1$ )**

Feed per tooth with radial depth of cut of 60% of the cutter ( $\varnothing d_1$ )

Avance par dent avec un engagement radial de 60% du diamètre de coupe ( $\varnothing d_1$ )

$\varnothing d_1$ [mm]	Korrekturfaktor / Correction factor / Facteur de correction									
	1	0,7	0,8	0,9	1,1	1,2	1,5	1,6	1,8	1,9
1	0,001	0,001	0,001	0,001	0,001	0,001	0,001	0,002	0,002	0,002
2	0,003	0,002	0,002	0,002	0,003	0,003	0,004	0,005	0,005	0,006
3	0,005	0,003	0,004	0,004	0,005	0,006	0,007	0,008	0,009	0,009
4	0,006	0,004	0,005	0,005	0,007	0,007	0,009	0,010	0,011	0,012
5	0,008	0,005	0,006	0,007	0,009	0,010	0,012	0,013	0,015	0,016
6	0,009	0,006	0,007	0,008	0,010	0,011	0,014	0,015	0,017	0,018
8	0,013	0,009	0,010	0,011	0,014	0,015	0,019	0,020	0,023	0,024
10	0,016	0,011	0,013	0,014	0,017	0,019	0,024	0,026	0,029	0,030
12	0,019	0,013	0,015	0,017	0,021	0,023	0,029	0,031	0,035	0,037
14	0,022	0,015	0,018	0,020	0,025	0,027	0,034	0,036	0,040	0,043
16	0,026	0,018	0,020	0,023	0,028	0,031	0,039	0,041	0,046	0,049
18	0,029	0,020	0,023	0,026	0,032	0,035	0,043	0,046	0,052	0,055
20	0,032	0,022	0,026	0,029	0,035	0,039	0,048	0,052	0,058	0,061
25	0,040	0,028	0,032	0,036	0,045	0,049	0,061	0,065	0,073	0,077

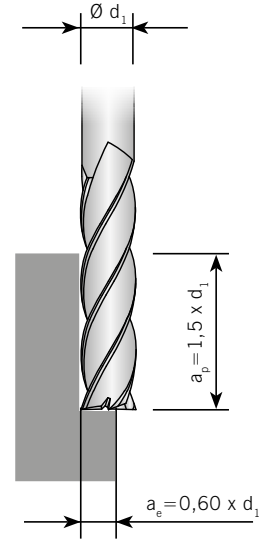

**Vorschub pro Zahn bei einer radialen Zustellung 80% vom Schneidendurchmesser ( $\varnothing d_1$ )**

Feed per tooth with radial depth of cut of 80% of the cutter ( $\varnothing d_1$ )

Avance par dent avec un engagement radial de 80% du diamètre de coupe ( $\varnothing d_1$ )

$\varnothing d_1$ [mm]	Korrekturfaktor / Correction factor / Facteur de correction									
	1	0,7	0,8	0,9	1,1	1,2	1,5	1,6	1,8	1,9
1	0,001	0,001	0,001	0,001	0,001	0,001	0,001	0,001	0,001	0,001
2	0,002	0,001	0,002	0,002	0,002	0,003	0,003	0,004	0,004	0,004
3	0,004	0,002	0,003	0,003	0,004	0,004	0,006	0,006	0,007	0,007
4	0,005	0,003	0,004	0,004	0,005	0,006	0,007	0,008	0,009	0,009
5	0,006	0,004	0,005	0,005	0,007	0,007	0,009	0,010	0,011	0,012
6	0,007	0,005	0,006	0,006	0,008	0,009	0,011	0,012	0,013	0,014
8	0,010	0,007	0,008	0,009	0,011	0,012	0,015	0,016	0,018	0,019
10	0,012	0,008	0,010	0,011	0,013	0,015	0,018	0,020	0,022	0,023
12	0,015	0,010	0,012	0,013	0,016	0,018	0,022	0,024	0,027	0,028
14	0,017	0,012	0,014	0,015	0,019	0,021	0,026	0,028	0,031	0,033
16	0,020	0,014	0,016	0,018	0,022	0,024	0,030	0,032	0,036	0,038
18	0,022	0,015	0,018	0,020	0,024	0,027	0,033	0,036	0,040	0,042
20	0,025	0,017	0,020	0,022	0,027	0,030	0,037	0,040	0,045	0,047
25	0,031	0,022	0,025	0,028	0,034	0,037	0,047	0,050	0,056	0,059

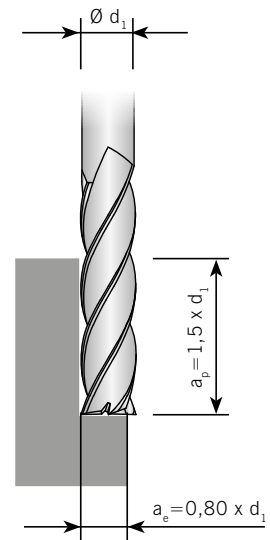

**Achtung:** Korrekturfaktor aus der Tabelle "Schnittgeschwindigkeiten" entnehmen.  
Korrekturfaktor -> 1,1 bei  $a_p = 1 \times d_1$  -> 1,2 bei  $a_p = 0,5 \times d_1$

Attention: Take the correction factor from the table "Cutting speeds".  
Correction factor -> 1,1 with  $a_p = 1 \times d_1$  -> 1,2 with  $a_p = 0,5 \times d_1$

Attention: Prenez le facteur de correction du tableau «Vitesses de coupe».  
Facteur de correction -> 1,1 pour  $a_p = 1 \times d_1$  -> 1,2 pour  $a_p = 0,5 \times d_1$

Recommended cutting data feed tables

Tableaux des avances valeurs de coupe recommandées

**Vorschub pro Zahn beim Vollnutfräsen →  $a_p = 0,5 \times d_1$**

Feed per tooth when full slot milling →  $a_p = 0,5 \times d_1$

Avance par dent pour le rainurage →  $a_p = 0,5 \times d_1$

Ø d <sub>1</sub> [mm]	Korrekturfaktor / Correction factor / Facteur de correction									
	1	0,7	0,8	0,9	1,1	1,2	1,5	1,6	1,8	1,9
1	0,002	0,001	0,001	0,001	0,002	0,002	0,003	0,003	0,003	0,003
2	0,004	0,002	0,003	0,003	0,004	0,004	0,006	0,006	0,007	0,007
3	0,007	0,004	0,005	0,006	0,007	0,008	0,010	0,011	0,012	0,013
4	0,009	0,006	0,007	0,008	0,009	0,010	0,013	0,014	0,016	0,017
5	0,011	0,007	0,008	0,009	0,012	0,013	0,016	0,017	0,019	0,020
6	0,013	0,009	0,010	0,011	0,014	0,015	0,019	0,020	0,023	0,024
8	0,018	0,012	0,014	0,016	0,019	0,021	0,027	0,028	0,032	0,034
10	0,022	0,015	0,017	0,019	0,024	0,026	0,033	0,035	0,039	0,041
12	0,030	0,021	0,024	0,027	0,033	0,036	0,045	0,048	0,054	0,057
14	0,032	0,022	0,025	0,028	0,035	0,038	0,048	0,051	0,057	0,060
16	0,036	0,025	0,028	0,032	0,039	0,043	0,054	0,057	0,064	0,068
18	0,042	0,029	0,033	0,037	0,046	0,050	0,063	0,067	0,075	0,079
20	0,045	0,031	0,036	0,040	0,049	0,054	0,067	0,072	0,081	0,085
25	0,056	0,039	0,044	0,050	0,061	0,067	0,084	0,089	0,100	0,106

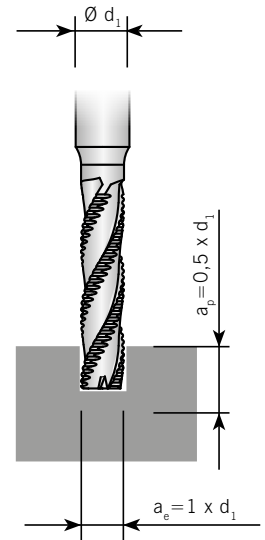

**Vorschub pro Zahn beim Vollnutfräsen →  $a_p = 1 \times d_1$**

Feed per tooth when full slot milling →  $a_p = 1 \times d_1$

Avance par dent pour le rainurage →  $a_p = 1 \times d_1$

Ø d <sub>1</sub> [mm]	Korrekturfaktor / Correction factor / Facteur de correction									
	1	0,7	0,8	0,9	1,1	1,2	1,5	1,6	1,8	1,9
1	0,001	0,001	0,001	0,001	0,001	0,002	0,002	0,002	0,002	0,002
2	0,003	0,002	0,002	0,002	0,003	0,003	0,004	0,004	0,005	0,005
3	0,005	0,003	0,004	0,004	0,005	0,005	0,007	0,007	0,008	0,009
4	0,006	0,004	0,005	0,005	0,006	0,007	0,009	0,009	0,011	0,011
5	0,007	0,005	0,006	0,006	0,008	0,009	0,011	0,011	0,013	0,014
6	0,008	0,006	0,007	0,008	0,009	0,010	0,013	0,014	0,015	0,016
8	0,012	0,008	0,009	0,011	0,013	0,014	0,018	0,019	0,021	0,022
10	0,014	0,010	0,011	0,013	0,016	0,017	0,021	0,023	0,026	0,027
12	0,020	0,014	0,016	0,018	0,021	0,023	0,029	0,031	0,035	0,037
14	0,021	0,015	0,017	0,019	0,023	0,025	0,031	0,033	0,037	0,040
16	0,023	0,016	0,019	0,021	0,026	0,028	0,035	0,037	0,042	0,044
18	0,027	0,019	0,022	0,025	0,030	0,033	0,041	0,044	0,049	0,052
20	0,029	0,020	0,023	0,026	0,032	0,035	0,044	0,047	0,053	0,056
25	0,036	0,025	0,029	0,033	0,040	0,044	0,055	0,058	0,066	0,069

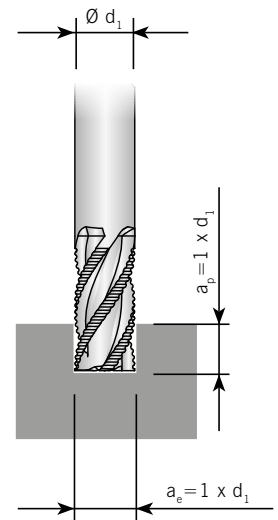

**Achtung:** Für unbeschichtete Werkzeuge ist der Vorschub um 10-20% zu reduzieren.

Attention: Feed rates are reduced by 10-20% for uncoated tools.

Attention: Pour les outils sans revêtement, l'avance doit être réduite de 10 à 20%.

AFV

## Vorschübe für Vollradius- und Torusfräser

Feed rates for ball nosed- and High feed cutters

Avances pour les fraises à rayon complet et toriques

Radiusfräser Ball nose end milling cutters Fraise à rayon		Radiusfräser Ball nose end milling cutters Fraise à rayon		Formenbau-Radiusfräser Ball nose cutter for mold and die production Fraise à rayon pour la fabrication de moules		Torusfräser Torus end milling cutters Fraise torique		Torusfräser Torus end milling cutters Fraise torique	
$d_1$ [mm]	fz [mm]	fz [mm]	fz [mm]	fz [mm]	fz [mm]	fz [mm]	fz [mm]	fz [mm]	fz [mm]
2	0,015	0,010	0,005	0,010	0,015	0,010	0,015	0,015	0,020
3	0,030	0,020	0,015	0,015	0,020	0,015	0,020	0,030	0,040
4	0,040	0,030	0,030	0,030	0,040	0,020	0,030	0,050	0,060
5	0,060	0,050	0,050	0,050	0,060	0,030	0,040	0,060	0,080
6	0,070	0,060	0,060	0,060	0,070	0,050	0,060	0,070	0,080
8	0,100	0,080	0,070	0,070	0,080	0,070	0,080	0,100	0,120
10	0,120	0,100	0,080	0,080	0,100	0,080	0,100	0,120	0,150
12	0,150	0,120	0,090	0,090	0,120	0,100	0,120	0,130	0,150
16	0,180	0,150	0,100	0,100	0,130	0,130	0,150	0,140	0,160
18	0,200	0,180	0,110	0,110	0,160	0,140	0,160	0,150	0,180
20	0,220	0,200	0,120	0,120	0,180	0,150	0,180	0,160	0,200
25	0,240	0,220	0,140	0,140	0,200	0,160	0,200	0,160	0,200

**Achtung:** Für unbeschichtete Werkzeuge ist der Vorschub um 10-20% zu reduzieren.

Attention: Feed rates are reduced by 10-20% for uncoated tools.

Attention: Pour les outils sans revêtement, l'avance doit être réduite de 10 à 20 %.

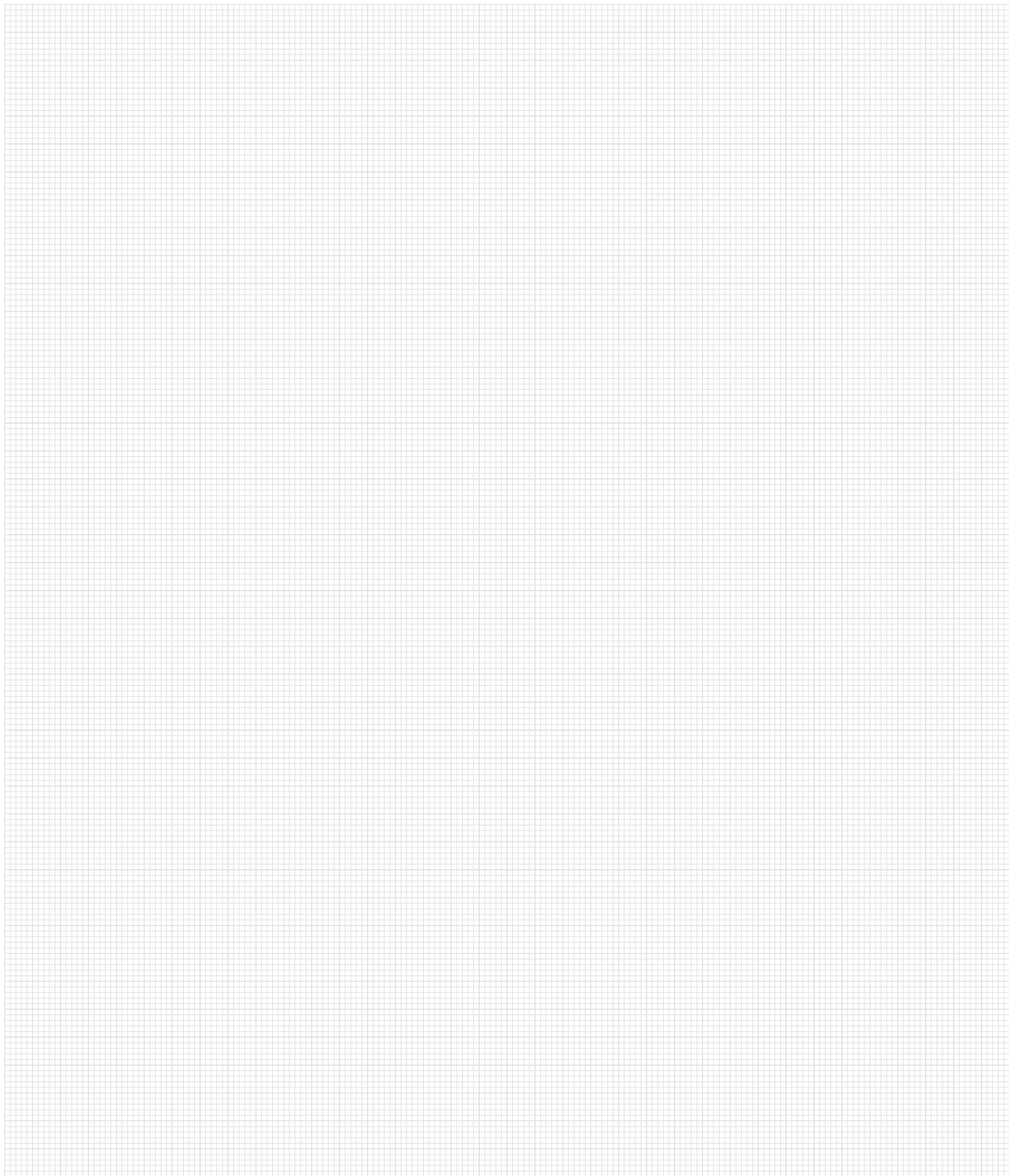

**Weitere Informationen finden Sie unter**

*For more information see*

*Pour plus d'informations*

**[www.arno.de](http://www.arno.de)**

# ARNO®

## WERKZEUGE

We have a passion for precision.

# AUSFÜHRUNG AFX

*Design AFX / Modèle AFX*

**Überzeugend in der Hochgeschwindigkeitsbearbeitung.**  
*Excellence in high speed machining.*  
Polyvalente et performante à grande vitesse.

Selbst bei der Hochgeschwindigkeitsbearbeitung von vorgehärteten oder naturharten Werkstoffen (bis 55 HRC) und Gusseisen erreichen die ARNO® AFX VHM-Fräser höchste Standzeiten.  
Auch für die Trockenbearbeitung geeignet.



*Even at high speed machining of pre-hardened or naturally hardened materials (up-to 55HRC) the ARNO® AFX cutters achieve excellent tool life. Also suitable for dry machining.*

Les fraises ARNO® AFX en carbure monobloc permettent d'obtenir une durée de vie maximale même en effectuant des usinages à grande vitesse de matériaux pré-durcis ou à dureté naturelle (jusqu'à 55 HRC) et de fontes. Convient également à l'usinage à sec.

## AFX50124-...R...

2 Schneiden, Mini-Ausführung, mit Eckenradius / 2 flutes, mini design, with corner radius / 2 dents, version mini, avec rayon d'angle

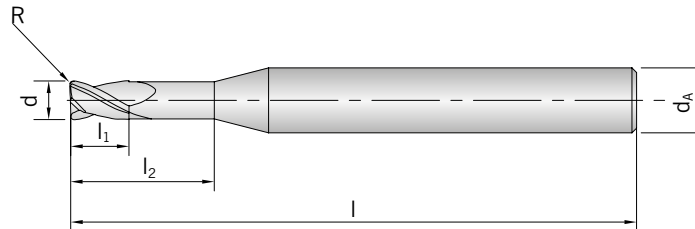
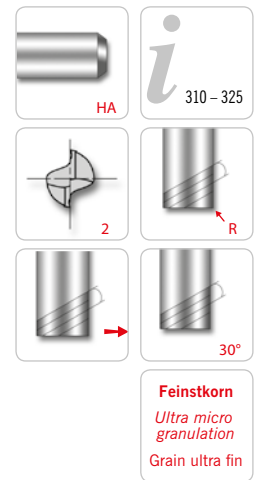

							PG 24
							beschichtet coated revêtu
Schaft DIN 6535HA Shank Tige	d -0,012	d <sub>A</sub> h6	l <sub>1</sub>	l <sub>2</sub>	l	R ±0,010	S100
AFX50124-002AR0,02	0,2	4	0,3	1,0	40	0,02	●
AFX50124-002AR0,05	0,2	4	0,3	1,0	40	0,05	●
AFX50124-003AR0,02	0,3	4	0,5	1,0	40	0,02	●
AFX50124-003AR0,05	0,3	4	0,5	1,0	40	0,05	●
AFX50124-003BR0,02	0,3	4	0,5	2,0	40	0,02	●
AFX50124-003BR0,05	0,3	4	0,5	2,0	40	0,05	●
AFX50124-004AR0,05	0,4	4	0,6	1,0	40	0,05	●
AFX50124-004AR0,1	0,4	4	0,6	1,0	40	0,10	●
AFX50124-004BR0,05	0,4	4	0,6	1,5	40	0,05	●
AFX50124-004BR0,1	0,4	4	0,6	2,0	40	0,10	●
AFX50124-004CR0,05	0,4	4	0,6	2,0	40	0,05	●
AFX50124-004DR0,05	0,4	4	0,6	2,5	40	0,05	●
AFX50124-005AR0,05	0,5	4	0,7	1,0	45	0,05	●
AFX50124-005AR0,1	0,5	4	0,7	2,0	45	0,10	●
AFX50124-005BR0,05	0,5	4	0,7	1,5	45	0,05	●
AFX50124-005BR0,1	0,5	4	0,7	3,0	45	0,10	●
AFX50124-005CR0,05	0,5	4	0,7	2,0	45	0,05	●
AFX50124-005DR0,05	0,5	4	0,7	4,0	45	0,05	●
AFX50124-006AR0,05	0,6	4	0,9	3,0	45	0,05	●
AFX50124-006AR0,1	0,6	4	0,9	2,0	45	0,10	●
AFX50124-006AR0,2	0,6	4	0,9	2,0	45	0,20	●
AFX50124-006BR0,05	0,6	4	0,9	6,0	45	0,05	●
AFX50124-006BR0,1	0,6	4	0,9	3,0	45	0,10	●
AFX50124-006BR0,2	0,6	4	0,9	4,0	45	0,20	●
AFX50124-006CR0,1	0,6	4	0,9	4,0	45	0,10	●
AFX50124-006CR0,2	0,6	4	0,9	6,0	45	0,20	●
AFX50124-006DR0,1	0,6	4	0,9	6,0	45	0,10	●
AFX50124-008AR0,05	0,8	4	1,2	2,0	45	0,05	●
AFX50124-008AR0,1	0,8	4	1,2	2,0	45	0,10	●
AFX50124-008AR0,2	0,8	4	1,2	2,0	45	0,20	●
AFX50124-008BR0,05	0,8	4	1,2	4,0	45	0,05	●
AFX50124-008BR0,1	0,8	4	1,2	4,0	45	0,10	●

							PG 24
							beschichtet coated revêtu
Schaft DIN 6535HA Shank Tige	d -0,012	d <sub>A</sub> h6	l <sub>1</sub>	l <sub>2</sub>	l	R ±0,010	S100
AFX50124-008BR0,2	0,8	4	1,2	4,0	45	0,20	●
AFX50124-008CR0,05	0,8	4	1,2	6,0	45	0,05	●
AFX50124-008CR0,1	0,8	4	1,2	6,0	45	0,10	●
AFX50124-008CR0,2	0,8	4	1,2	6,0	45	0,20	●
AFX50124-008DR0,1	0,8	4	1,2	8,0	45	0,10	●
AFX50124-008DR0,2	0,8	4	1,2	8,0	45	0,20	●
AFX50124-010AR0,05	1,0	4	1,5	3,0	50	0,05	●
AFX50124-010AR0,1	1,0	4	1,5	3,0	50	0,10	●
AFX50124-010AR0,2	1,0	4	1,5	3,0	50	0,20	●
AFX50124-010AR0,3	1,0	4	1,5	4,0	50	0,30	●
AFX50124-010BR0,05	1,0	4	1,5	4,0	50	0,05	●
AFX50124-010BR0,1	1,0	4	1,5	4,0	50	0,10	●
AFX50124-010BR0,2	1,0	4	1,5	4,0	50	0,20	●
AFX50124-010BR0,3	1,0	4	1,5	6,0	50	0,30	●
AFX50124-010CR0,05	1,0	4	1,5	6,0	50	0,05	●
AFX50124-010CR0,1	1,0	4	1,5	6,0	50	0,10	●
AFX50124-010CR0,2	1,0	4	1,5	6,0	50	0,20	●
AFX50124-010CR0,3	1,0	4	1,5	8,0	50	0,30	●
AFX50124-010DR0,1	1,0	4	1,5	8,0	50	0,10	●
AFX50124-010DR0,2	1,0	4	1,5	8,0	50	0,20	●
AFX50124-010DR0,3	1,0	4	1,5	10,0	50	0,30	●
AFX50124-010ER0,1	1,0	4	1,5	10,0	50	0,10	●
AFX50124-010ER0,2	1,0	4	1,5	10,0	50	0,20	●
AFX50124-010FR0,2	1,0	4	1,5	12,0	50	0,20	●
AFX50124-012AR0,05	1,2	4	1,8	6,0	50	0,05	●
AFX50124-012AR0,1	1,2	4	1,8	4,0	50	0,10	●
AFX50124-012AR0,2	1,2	4	1,8	4,0	50	0,20	●
AFX50124-012AR0,3	1,2	4	1,8	4,0	50	0,30	●
AFX50124-012BR0,05	1,2	4	1,8	8,0	50	0,05	●
AFX50124-012BR0,1	1,2	4	1,8	6,0	50	0,10	●
AFX50124-012BR0,2	1,2	4	1,8	6,0	50	0,20	●
AFX50124-012BR0,3	1,2	4	1,8	6,0	50	0,30	●
AFX50124-012CR0,05	1,2	4	1,8	10,0	50	0,05	●
AFX50124-012CR0,1	1,2	4	1,8	8,0	50	0,10	●
AFX50124-012CR0,2	1,2	4	1,8	8,0	50	0,20	●
AFX50124-012CR0,3	1,2	4	1,8	8,0	50	0,30	●
AFX50124-015AR0,05	1,5	4	2,3	4,0	50	0,05	●
AFX50124-015AR0,1	1,5	4	2,3	4,0	50	0,10	●
AFX50124-015AR0,2	1,5	4	2,3	8,0	50	0,20	●
AFX50124-015AR0,3	1,5	4	2,3	4,0	50	0,30	●
AFX50124-015AR0,5	1,5	4	2,3	4,0	50	0,50	●
AFX50124-015BR0,05	1,5	4	2,3	6,0	50	0,05	●
AFX50124-015BR0,1	1,5	4	2,3	6,0	50	0,10	●
AFX50124-015BR0,2	1,5	4	2,3	10,0	50	0,20	●
AFX50124-015BR0,3	1,5	4	2,3	6,0	50	0,30	●
AFX50124-015BR0,5	1,5	4	2,3	12,0	50	0,50	●
AFX50124-015CR0,05	1,5	4	2,3	8,0	50	0,05	●
AFX50124-015CR0,1	1,5	4	2,3	8,0	50	0,10	●
AFX50124-015CR0,2	1,5	4	2,3	12,0	50	0,20	●
AFX50124-015CR0,3	1,5	4	2,3	8,0	50	0,30	●
AFX50124-015DR0,2	1,5	4	2,3	4,0	50	0,20	●
AFX50124-015DR0,3	1,5	4	2,3	10,0	50	0,30	●
AFX50124-015ER0,2	1,5	4	2,3	6,0	50	0,20	●
AFX50124-015ER0,3	1,5	4	2,3	12,0	50	0,30	●
AFX50124-020AR0,1	2,0	4	3,0	6,0	50	0,10	●
AFX50124-020AR0,2	2,0	4	3,0	6,0	50	0,20	●

PG 24

beschichtet  
coated  
revêtu

Schaft DIN 6535HA Shank Tige	d -0,012	d <sub>A</sub> h6	l <sub>1</sub>	l <sub>2</sub>	l	R ±0,010	S100
AFX50124-020AR0,3	2,0	4	3,0	6,0	50	0,30	●
AFX50124-020AR0,5	2,0	4	3,0	6,0	50	0,50	●
AFX50124-020BR0,1	2,0	4	3,0	8,0	50	0,10	●
AFX50124-020BR0,2	2,0	4	3,0	8,0	50	0,20	●
AFX50124-020BR0,3	2,0	4	3,0	8,0	50	0,30	●
AFX50124-020BR0,5	2,0	4	3,0	8,0	50	0,50	●
AFX50124-020CR0,1	2,0	4	3,0	10,0	50	0,10	●
AFX50124-020CR0,2	2,0	4	3,0	10,0	50	0,20	●
AFX50124-020CR0,3	2,0	4	3,0	10,0	50	0,30	●
AFX50124-020CR0,5	2,0	4	3,0	10,0	50	0,50	●
AFX50124-020DR0,1	2,0	4	3,0	12,0	50	0,10	●
AFX50124-020DR0,2	2,0	4	3,0	12,0	50	0,20	●
AFX50124-020DR0,3	2,0	4	3,0	12,0	50	0,30	●
AFX50124-020DR0,5	2,0	4	3,0	12,0	50	0,50	●
AFX50124-020ER0,2	2,0	4	3,0	16,0	50	0,20	●
AFX50124-020ER0,3	2,0	4	3,0	16,0	50	0,30	●
AFX50124-020ER0,5	2,0	4	3,0	14,0	50	0,50	●
AFX50124-020FR0,5	2,0	4	3,0	16,0	50	0,50	●
AFX50124-030AR0,1	3,0	6	4,5	10,0	50	0,10	●
AFX50124-030AR0,2	3,0	6	4,5	8,0	50	0,20	●
AFX50124-030AR0,3	3,0	6	4,5	8,0	50	0,30	●
AFX50124-030AR0,5	3,0	6	4,5	8,0	50	0,50	●
AFX50124-030AR1,0	3,0	6	4,5	8,0	50	1,00	●
AFX50124-030BR0,1	3,0	6	4,5	12,0	50	0,10	●
AFX50124-030BR0,2	3,0	6	4,5	10,0	50	0,20	●
AFX50124-030BR0,3	3,0	6	4,5	10,0	50	0,30	●
AFX50124-030BR0,5	3,0	6	4,5	10,0	50	0,50	●
AFX50124-030BR1,0	3,0	6	4,5	10,0	50	1,00	●
AFX50124-030CR0,1	3,0	6	4,5	16,0	60	0,10	●
AFX50124-030CR0,2	3,0	6	4,5	12,0	50	0,20	●
AFX50124-030CR0,3	3,0	6	4,5	12,0	50	0,30	●
AFX50124-030CR0,5	3,0	6	4,5	12,0	50	0,50	●
AFX50124-030CR1,0	3,0	6	4,5	12,0	50	1,00	●
AFX50124-030DR0,2	3,0	6	4,5	16,0	60	0,20	●
AFX50124-030DR0,3	3,0	6	4,5	16,0	60	0,30	●
AFX50124-030DR0,5	3,0	6	4,5	16,0	60	0,50	●
AFX50124-030DR1,0	3,0	6	4,5	16,0	60	1,00	●
AFX50124-030ER0,2	3,0	6	4,5	20,0	60	0,20	●
AFX50124-030ER0,3	3,0	6	4,5	20,0	60	0,30	●
AFX50124-030ER0,5	3,0	6	4,5	20,0	60	0,50	●
AFX50124-030ER1,0	3,0	6	4,5	20,0	60	1,00	●
AFX50124-030FR0,2	3,0	6	4,5	26,0	65	0,20	●
AFX50124-030FR0,5	3,0	6	4,5	26,0	65	0,50	●
AFX50124-040AR0,1	4,0	6	6,0	10,0	50	0,10	●
AFX50124-040AR0,2	4,0	6	6,0	10,0	50	0,20	●
AFX50124-040AR0,3	4,0	6	6,0	12,0	50	0,30	●
AFX50124-040AR0,5	4,0	6	6,0	10,0	50	0,50	●
AFX50124-040AR1,0	4,0	6	6,0	10,0	50	1,00	●
AFX50124-040BR0,1	4,0	6	6,0	12,0	50	0,10	●
AFX50124-040BR0,2	4,0	6	6,0	12,0	50	0,20	●
AFX50124-040BR0,3	4,0	6	6,0	16,0	60	0,30	●
AFX50124-040BR0,5	4,0	6	6,0	12,0	50	0,50	●
AFX50124-040BR1,0	4,0	6	6,0	12,0	50	1,00	●
AFX50124-040CR0,1	4,0	6	6,0	16,0	60	0,10	●
AFX50124-040CR0,2	4,0	6	6,0	16,0	60	0,20	●
AFX50124-040CR0,3	4,0	6	6,0	20,0	60	0,30	●



								PG 24
								beschichtet coated revêtu
Schaft DIN 6535HA Shank Tige	d -0,012	d <sub>A</sub> h6	l <sub>1</sub>	l <sub>2</sub>	l	R ±0,010	S100	
AFX50124-040CR0,5	4,0	6	6,0	16,0	60	0,50	●	
AFX50124-040CR1,0	4,0	6	6,0	16,0	60	1,00	●	
AFX50124-040DR0,2	4,0	6	6,0	20,0	60	0,20	●	
AFX50124-040DR0,3	4,0	6	6,0	26,0	65	0,30	●	
AFX50124-040DR0,5	4,0	6	6,0	20,0	60	0,50	●	
AFX50124-040DR1,0	4,0	6	6,0	20,0	60	1,00	●	
AFX50124-040ER0,2	4,0	6	6,0	26,0	65	0,20	●	
AFX50124-040ER0,5	4,0	6	6,0	26,0	65	0,50	●	
AFX50124-040FR0,5	4,0	6	6,0	30,0	70	0,50	●	

P	●
M	
K	●
N	
S	
H	●

● **Hauptanwendung**  
Main application  
Application principale

○ **Nebenanwendung**  
Secondary application  
Application secondaire

								PG 24
								beschichtet coated revêtu
Schaft DIN 6535HA Shank Tige	d -0,015	d <sub>A</sub> h6	l <sub>1</sub>	l <sub>2</sub>	l	R ±0,015	S100	
AFX50124-060AR0,2	6	6	9	20	60	0,2	●	
AFX50124-060AR0,3	6	6	9	20	60	0,3	●	
AFX50124-060AR0,5	6	6	9	20	60	0,5	●	
AFX50124-060AR1,0	6	6	9	20	60	1,0	●	
AFX50124-060BR0,5	6	6	15	30	90	0,5	●	
AFX50124-080AR0,2	8	8	12	25	70	0,2	●	
AFX50124-080AR0,3	8	8	12	25	70	0,3	●	
AFX50124-080AR0,5	8	8	12	25	70	0,5	●	
AFX50124-080AR1,0	8	8	15	25	70	1,0	●	
AFX50124-100AR0,3	10	10	15	30	75	0,3	●	
AFX50124-100AR0,5	10	10	15	30	75	0,5	●	
AFX50124-100AR1,0	10	10	18	30	75	1,0	●	
AFX50124-120AR0,5	12	12	18	32	80	0,5	●	
AFX50124-120AR1,0	12	12	18	32	80	1,0	●	
AFX50124-120AR1,5	12	12	18	32	80	1,5	●	
AFX50124-160AR0,5	16	16	20	35	100	0,5	●	
AFX50124-160AR1,0	16	16	20	35	100	1,0	●	
AFX50124-200AR0,5	20	20	25	40	100	0,5	●	
AFX50124-200AR1,0	20	20	25	40	100	1,0	●	

P	●
M	
K	●
N	
S	
H	●

● **Hauptanwendung**  
Main application  
Application principale

○ **Nebenanwendung**  
Secondary application  
Application secondaire

Solid carbide end-mill  
Fraise carbure monobloc à tige

## AFX50120-...

2 Schneiden, kurze Ausführung / 2 flutes, short design / 2 dents, version courte

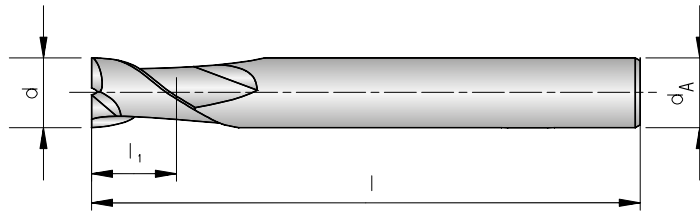

						PG 24
						beschichtet coated revêtu
Schaft DIN 6535HA Shank Tige	d -0,012	d <sub>A</sub> h6	l <sub>1</sub>	l	Ø100	
AFX50120-001	0,1	4	0,2	40	●	
AFX50120-002	0,2	4	0,4	40	●	
AFX50120-003	0,3	4	0,6	40	●	
AFX50120-004	0,4	4	0,8	40	●	
AFX50120-005	0,5	4	1,0	40	●	
AFX50120-006	0,6	4	1,2	40	●	
AFX50120-007	0,7	4	1,4	40	●	
AFX50120-008	0,8	4	1,6	40	●	
AFX50120-009	0,9	4	1,8	40	●	
AFX50120-010	1,0	6	2,5	50	●	
AFX50120-012	1,2	6	3,0	50	●	
AFX50120-015	1,5	6	4,0	50	●	
AFX50120-020	2,0	6	6,0	50	●	
AFX50120-025	2,5	6	7,0	50	●	
AFX50120-030	3,0	6	8,0	50	●	
AFX50120-035	3,5	6	10,0	50	●	
AFX50120-040	4,0	6	10,0	50	●	
AFX50120-045	4,5	6	14,0	50	●	
AFX50120-050	5,0	6	15,0	60	●	
AFX50120-055	5,5	6	15,0	60	●	

P	●
M	●
K	●
N	
S	
H	●

● Hauptanwendung  
Main application  
Application principale  
○ Nebenanwendung  
Secondary application  
Application secondaire

AFX

						PG 24
						beschichtet coated revêtu
Schaft DIN 6535HA Shank Tige	d -0,015	d <sub>A</sub> h6	l <sub>1</sub>	l	S100	
AFX50120-060	6,0	6	15	60	●	
AFX50120-065	6,5	8	18	60	●	
AFX50120-070	7,0	8	20	60	●	
AFX50120-075	7,5	8	20	60	●	
AFX50120-080	8,0	8	20	70	●	
AFX50120-085	8,5	10	22	70	●	
AFX50120-090	9,0	10	22	70	●	
AFX50120-095	9,5	10	24	70	●	
AFX50120-100	10,0	10	25	75	●	
AFX50120-105	10,5	12	26	75	●	
AFX50120-110	11,0	12	30	75	●	
AFX50120-115	11,5	12	30	80	●	
AFX50120-120	12,0	12	30	80	●	
AFX50120-130	13,0	12	35	100	●	
AFX50120-140	14,0	16	35	100	●	
AFX50120-150	15,0	16	38	100	●	
AFX50120-160	16,0	16	40	100	●	
AFX50120-180	18,0	16	45	100	●	
AFX50120-200	20,0	20	45	100	●	

P	●
M	
K	●
N	
S	
H	●

- Hauptanwendung  
Main application  
Application principale
- Nebenanwendung  
Secondary application  
Application secondaire

Solid carbide end-mill  
Fraise carbure monobloc à tige

## AFX50121-...

2 Schneiden, lange Ausführung / 2 flutes, long design / 2 dents, version longue

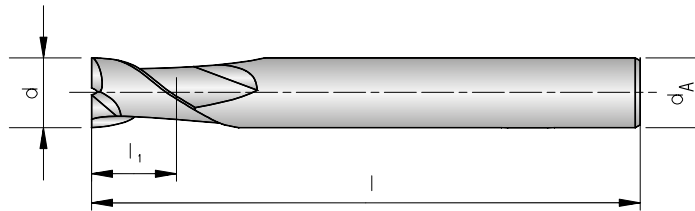

						PG 24
						beschichtet coated revêtu
Schaft DIN 6535HA Shank Tige	d -0,03	d <sub>A</sub> h6	l <sub>1</sub>	l		0015
AFX50121-010A	1,0	6	3	60		●
AFX50121-010B	1,0	6	4	60		●
AFX50121-010C	1,0	6	6	60		●
AFX50121-010D	1,0	6	8	60		●
AFX50121-010E	1,0	6	10	60		●
AFX50121-015A	1,5	6	6	60		●
AFX50121-015B	1,5	6	8	60		●
AFX50121-015C	1,5	6	10	60		●
AFX50121-015D	1,5	6	12	60		●
AFX50121-015E	1,5	6	16	60		●
AFX50121-020A	2,0	6	8	60		●
AFX50121-020B	2,0	6	10	60		●
AFX50121-020C	2,0	6	12	60		●
AFX50121-020D	2,0	6	16	60		●
AFX50121-025A	2,5	6	10	60		●
AFX50121-025B	2,5	6	16	60		●
AFX50121-030A	3,0	6	10	70		●
AFX50121-030B	3,0	6	12	70		●
AFX50121-030C	3,0	6	16	70		●
AFX50121-030D	3,0	6	20	70		●
AFX50121-030E	3,0	6	26	70		●
AFX50121-040A	4,0	6	12	70		●
AFX50121-040B	4,0	6	16	70		●
AFX50121-040C	4,0	6	20	70		●
AFX50121-040D	4,0	6	26	70		●
AFX50121-040E	4,0	6	30	70		●
AFX50121-050A	5,0	6	20	70		●
AFX50121-050B	5,0	6	25	70		●
AFX50121-050C	5,0	6	30	80		●
AFX50121-050D	5,0	6	40	100		●
AFX50121-060A	6,0	6	15	60		●
AFX50121-060B	6,0	6	15	80		●
AFX50121-060C	6,0	6	20	70		●

AFX

						PG 24
						beschichtet coated revêtu
Schaft DIN 6535HA Shank Tige	d -0,03	d <sub>A</sub> h6	l <sub>1</sub>	l	S100	
AFX50121-060D	6,0	6	20	90	●	
AFX50121-060E	6,0	6	25	75	●	
AFX50121-060F	6,0	6	30	80	●	
AFX50121-060G	6,0	6	30	100	●	
AFX50121-060H	6,0	6	30	150	●	
AFX50121-060I	6,0	6	35	90	●	
AFX50121-060J	6,0	6	40	90	●	
AFX50121-060K	6,0	6	45	150	●	
AFX50121-080A	8,0	8	25	80	●	
AFX50121-080B	8,0	8	30	80	●	
AFX50121-080C	8,0	8	35	90	●	
AFX50121-080D	8,0	8	40	90	●	
AFX50121-080E	8,0	8	40	120	●	
AFX50121-080F	8,0	8	45	100	●	
AFX50121-080G	8,0	8	50	100	●	
AFX50121-100A	10,0	10	30	80	●	
AFX50121-100B	10,0	10	30	100	●	
AFX50121-100C	10,0	10	35	90	●	
AFX50121-100D	10,0	10	40	90	●	
AFX50121-100E	10,0	10	40	120	●	
AFX50121-100F	10,0	10	45	100	●	
AFX50121-100G	10,0	10	50	100	●	
AFX50121-100H	10,0	10	50	150	●	
AFX50121-100I	10,0	10	60	110	●	
AFX50121-120A	12,0	12	35	90	●	
AFX50121-120B	12,0	12	40	100	●	
AFX50121-120C	12,0	12	40	120	●	
AFX50121-120D	12,0	12	45	130	●	
AFX50121-120E	12,0	12	50	100	●	
AFX50121-120F	12,0	12	55	110	●	
AFX50121-120G	12,0	12	60	110	●	
AFX50121-120H	12,0	12	60	150	●	
AFX50121-140	14,0	16	50	110	●	
AFX50121-160A	16,0	16	40	150	●	
AFX50121-160B	16,0	16	50	110	●	
AFX50121-180	18,0	20	50	120	●	
AFX50121-200A	20,0	20	90	200	●	
AFX50121-200B	20,0	20	110	200	●	

P	●
M	
K	●
N	
S	
H	●

- **Hauptanwendung**  
Main application  
Application principale
- **Nebenanwendung**  
Secondary application  
Application secondaire

AFX

Solid carbide end-mill

Fraise carbure monobloc à tige

## AFX50121-...R...

2 Schneiden, lange Ausführung mit Eckenradius / 2 flutes, long design with corner radius / 2 dents, version longue, avec rayon d'angle

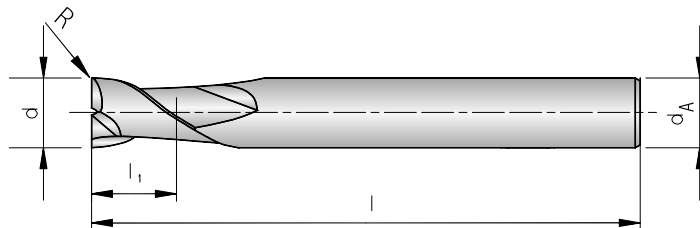
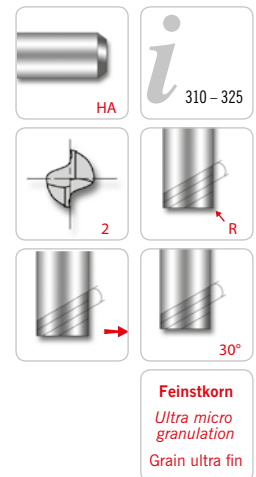

							PG 24
							beschichtet coated revêtu
Schaft DIN 6535HA Shank Tige	d -0,012	d <sub>A</sub> h6	l <sub>1</sub>	l	R ±0,010	S100	
AFX50121-010AR0,1	1,0	6	2,5	50	0,1	●	
AFX50121-010AR0,2	1,0	6	2,5	50	0,2	●	
AFX50121-010AR0,3	1,0	6	2,5	50	0,3	●	
AFX50121-015AR0,2	1,5	6	4,0	50	0,2	●	
AFX50121-015AR0,3	1,5	6	4,0	50	0,3	●	
AFX50121-015AR0,5	1,5	6	4,0	50	0,5	●	
AFX50121-020AR0,1	2,0	6	6,0	50	0,1	●	
AFX50121-020AR0,2	2,0	6	6,0	50	0,2	●	
AFX50121-020AR0,3	2,0	6	6,0	50	0,3	●	
AFX50121-020AR0,5	2,0	6	6,0	50	0,5	●	
AFX50121-030AR0,1	3,0	6	8,0	60	0,1	●	
AFX50121-030AR0,2	3,0	6	8,0	60	0,2	●	
AFX50121-030AR0,3	3,0	6	8,0	60	0,3	●	
AFX50121-030AR0,5	3,0	6	8,0	60	0,5	●	
AFX50121-040AR0,2	4,0	6	10,0	70	0,2	●	
AFX50121-040AR0,3	4,0	6	10,0	70	0,3	●	
AFX50121-040AR0,5	4,0	6	10,0	70	0,5	●	
AFX50121-040AR1,0	4,0	6	10,0	70	1,0	●	
AFX50121-050AR0,2	5,0	6	13,0	90	0,2	●	
AFX50121-050AR0,3	5,0	6	13,0	90	0,3	●	
AFX50121-050AR0,5	5,0	6	13,0	90	0,5	●	
AFX50121-050AR1,0	5,0	6	13,0	90	1,0	●	

P	●
M	
K	●
N	
S	
H	●

● Hauptanwendung  
Main application  
Application principale

○ Nebenanwendung  
Secondary application  
Application secondaire

PG 24

beschichtet  
coated  
revêtu

Schaft DIN 6535HA Shank Tige	d -0,015	d <sub>A</sub> h6	l <sub>1</sub>	l	R ±0,015	S100
AFX50121-060AR0,2	6	6	15	60	0,2	●
AFX50121-060AR0,3	6	6	15	60	0,3	●
AFX50121-060AR0,5	6	6	15	60	0,5	●
AFX50121-060AR1,0	6	6	15	60	1,0	●
AFX50121-060BR0,2	6	6	15	90	0,2	●
AFX50121-060BR0,3	6	6	15	90	0,3	●
AFX50121-060BR0,5	6	6	15	90	0,5	●
AFX50121-060BR1,0	6	6	15	90	1,0	●
AFX50121-060CR1,0	6	6	15	110	1,0	●
AFX50121-060DR1,0	6	6	15	130	1,0	●
AFX50121-080AR0,2	8	8	20	100	0,2	●
AFX50121-080AR0,3	8	8	20	70	0,3	●
AFX50121-080AR0,5	8	8	20	70	0,5	●
AFX50121-080AR1,0	8	8	20	70	1,0	●
AFX50121-080AR2,0	8	8	20	100	2,0	●
AFX50121-080BR0,5	8	8	20	100	0,5	●
AFX50121-080BR1,0	8	8	20	100	1,0	●
AFX50121-080BR1,5	8	8	20	100	1,5	●
AFX50121-100AR0,2	10	10	25	100	0,2	●
AFX50121-100AR0,5	10	10	25	75	0,5	●
AFX50121-100AR1,0	10	10	25	75	1,0	●
AFX50121-100AR1,5	10	10	25	100	1,5	●
AFX50121-100AR2,0	10	10	25	100	2,0	●
AFX50121-100BR0,5	10	10	25	100	0,5	●
AFX50121-100BR1,0	10	10	25	100	1,0	●
AFX50121-120AR0,3	12	12	30	110	0,3	●
AFX50121-120AR0,5	12	12	30	80	0,5	●
AFX50121-120AR1,0	12	12	30	80	1,0	●
AFX50121-120AR1,5	12	12	30	110	1,5	●
AFX50121-120AR2,0	12	12	30	110	2,0	●
AFX50121-120AR2,5	12	12	30	110	2,5	●
AFX50121-120AR3,0	12	12	30	110	3,0	●
AFX50121-120BR0,5	12	12	30	110	0,5	●
AFX50121-120BR1,0	12	12	30	110	1,0	●
AFX50121-120CR1,0	12	12	30	130	1,0	●
AFX50121-160AR1,0	16	16	35	150	1,0	●
AFX50121-160AR2,0	16	16	32	150	2,0	●
AFX50121-160BR1,0	16	16	32	150	1,0	●
AFX50121-200AR1,0	20	20	38	150	1,0	●
AFX50121-200AR2,0	20	20	38	150	2,0	●

P	●
M	
K	●
N	
S	
H	●

● Hauptanwendung  
Main application  
Application principale

○ Nebenanwendung  
Secondary application  
Application secondaire

Solid carbide end-mill

Fraise carbure monobloc à tige

## AFX50122-...

2 Schneiden, extra lange Ausführung / 2 flutes, extra long design / 2 dents, version extra longue

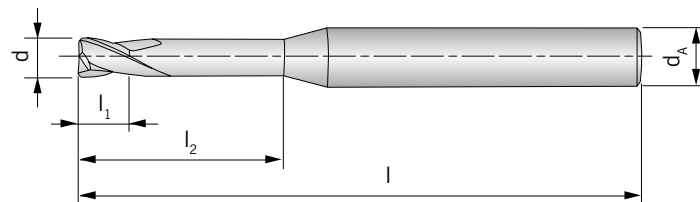

PG 24

beschichtet  
coated  
revêtu

Schaft DIN 6535HA Shank Tige	d -0,012	d <sub>A</sub> h6	l <sub>1</sub>	l <sub>2</sub>	l	S100
AFX50122-002A	0,2	4	0,3	1,0	40	●
AFX50122-003A	0,3	4	0,5	1,5	40	●
AFX50122-003B	0,3	4	0,5	2,0	40	●
AFX50122-004A	0,4	4	0,6	1,0	40	●
AFX50122-004B	0,4	4	0,6	1,5	40	●
AFX50122-004C	0,4	4	0,6	2,0	40	●
AFX50122-004D	0,4	4	0,6	3,0	40	●
AFX50122-004E	0,4	4	0,6	4,0	40	●
AFX50122-004F	0,4	4	0,6	5,0	40	●
AFX50122-005A	0,5	4	0,7	2,0	45	●
AFX50122-005B	0,5	4	0,7	3,0	45	●
AFX50122-005C	0,5	4	0,7	4,0	45	●
AFX50122-005D	0,5	4	0,7	5,0	45	●
AFX50122-005E	0,5	4	0,7	6,0	45	●
AFX50122-006A	0,6	4	0,9	2,0	45	●
AFX50122-006B	0,6	4	0,9	3,0	45	●
AFX50122-006C	0,6	4	0,9	4,0	45	●
AFX50122-006D	0,6	4	0,9	5,0	45	●
AFX50122-006E	0,6	4	0,9	6,0	45	●
AFX50122-006F	0,6	4	0,9	8,0	45	●
AFX50122-006G	0,6	4	0,9	10,0	45	●
AFX50122-008A	0,8	4	1,2	2,0	45	●
AFX50122-008B	0,8	4	1,2	3,0	45	●
AFX50122-008C	0,8	4	1,2	4,0	45	●
AFX50122-008D	0,8	4	1,2	5,0	45	●
AFX50122-008E	0,8	4	1,2	6,0	45	●
AFX50122-008F	0,8	4	1,2	8,0	45	●
AFX50122-008G	0,8	4	1,2	10,0	45	●
AFX50122-010A	1,0	4	1,5	3,0	50	●
AFX50122-010B	1,0	4	1,5	4,0	50	●

AFX



							PG 24
							beschichtet coated revêtu
Schaft DIN 6535HA Shank Tige	d -0,012	d <sub>A</sub> h6	l <sub>1</sub>	l <sub>2</sub>	l	S100	
AFX50122-010C	1,0	4	1,5	5,0	50	●	
AFX50122-010D	1,0	4	1,5	6,0	50	●	
AFX50122-010E	1,0	4	1,5	8,0	50	●	
AFX50122-010F	1,0	4	1,5	10,0	50	●	
AFX50122-010G	1,0	4	1,5	12,0	50	●	
AFX50122-010H	1,0	4	1,5	14,0	50	●	
AFX50122-010I	1,0	4	1,5	16,0	50	●	
AFX50122-010J	1,0	4	1,5	20,0	50	●	
AFX50122-012A	1,2	4	1,8	6,0	50	●	
AFX50122-012B	1,2	4	1,8	8,0	50	●	
AFX50122-012C	1,2	4	1,8	10,0	50	●	
AFX50122-014A	1,4	4	2,1	6,0	50	●	
AFX50122-014B	1,4	4	2,1	8,0	50	●	
AFX50122-015A	1,5	4	2,3	4,0	50	●	
AFX50122-015B	1,5	4	2,3	6,0	50	●	
AFX50122-015C	1,5	4	2,3	8,0	50	●	
AFX50122-015D	1,5	4	2,3	10,0	50	●	
AFX50122-015E	1,5	4	2,3	12,0	50	●	
AFX50122-015F	1,5	4	2,3	14,0	50	●	
AFX50122-015G	1,5	4	2,3	16,0	50	●	
AFX50122-015H	1,5	4	2,3	20,0	50	●	
AFX50122-018A	1,8	4	2,7	8,0	50	●	
AFX50122-018B	1,8	4	2,7	10,0	50	●	
AFX50122-018C	1,8	4	2,7	12,0	50	●	
AFX50122-020A	2,0	4	3,0	6,0	50	●	
AFX50122-020B	2,0	4	3,0	8,0	50	●	
AFX50122-020C	2,0	4	3,0	10,0	50	●	
AFX50122-020D	2,0	4	3,0	12,0	50	●	
AFX50122-020E	2,0	4	3,0	14,0	50	●	
AFX50122-020F	2,0	4	3,0	16,0	50	●	
AFX50122-020G	2,0	4	3,0	20,0	50	●	
AFX50122-025A	2,5	4	4,0	8,0	50	●	
AFX50122-025B	2,5	4	4,0	12,0	50	●	
AFX50122-025C	2,5	4	4,0	16,0	50	●	
AFX50122-025D	2,5	4	4,0	20,0	50	●	
AFX50122-030A	3,0	6	4,5	8,0	50	●	
AFX50122-030B	3,0	6	4,5	10,0	50	●	
AFX50122-030C	3,0	6	4,5	12,0	50	●	
AFX50122-030D	3,0	6	4,5	14,0	60	●	
AFX50122-030E	3,0	6	4,5	16,0	60	●	
AFX50122-030F	3,0	6	4,5	18,0	60	●	
AFX50122-030G	3,0	6	4,5	20,0	60	●	
AFX50122-030H	3,0	6	4,5	26,0	65	●	
AFX50122-040A	4,0	6	6,0	10,0	50	●	
AFX50122-040B	4,0	6	6,0	12,0	50	●	
AFX50122-040C	4,0	6	6,0	16,0	60	●	
AFX50122-040D	4,0	6	6,0	18,0	60	●	
AFX50122-040E	4,0	6	6,0	20,0	60	●	
AFX50122-040F	4,0	6	6,0	26,0	65	●	
AFX50122-040G	4,0	6	6,0	30,0	70	●	
AFX50122-050A	5,0	6	8,0	20,0	60	●	
AFX50122-050B	5,0	6	8,0	30,0	70	●	

							PG 24
							beschichtet coated revêtu
Schaft DIN 6535HA Shank Tige	d -0,012	d <sub>A</sub> h6	l <sub>1</sub>	l <sub>2</sub>	l	S100	
AFX50122-050C	5,0	6	8,0	35,0	75	●	
AFX50122-050D	5,0	6	8,0	40,0	80	●	
AFX50122-050E	5,0	6	8,0	50,0	90	●	

P	●
M	
K	●
N	
S	
H	●

- **Hauptanwendung**  
Main application  
Application principale
- **Nebenanwendung**  
Secondary application  
Application secondaire

							PG 24
							beschichtet coated revêtu
Schaft DIN 6535HA Shank Tige	d -0,015	d <sub>A</sub> h6	l <sub>1</sub>	l <sub>2</sub>	l	S105	
AFX50122-060A	6	6	9	15	60	●	
AFX50122-060B	6	6	9	20	60	●	
AFX50122-060C	6	6	9	30	70	●	
AFX50122-080A	8	8	12	25	70	●	
AFX50122-100A	10	10	15	30	75	●	
AFX50122-100B	10	10	15	45	100	●	
AFX50122-120A	12	12	20	35	80	●	
AFX50122-120B	12	12	20	50	110	●	

P	●
M	
K	●
N	
S	
H	●

- **Hauptanwendung**  
Main application  
Application principale
- **Nebenanwendung**  
Secondary application  
Application secondaire

Solid carbide ball-nose end-mill  
Fraise carbure monobloc hémisphérique

## AFX50321-...

2 Schneiden, lange Ausführung / 2 flutes, long design / 2 dents, version longue

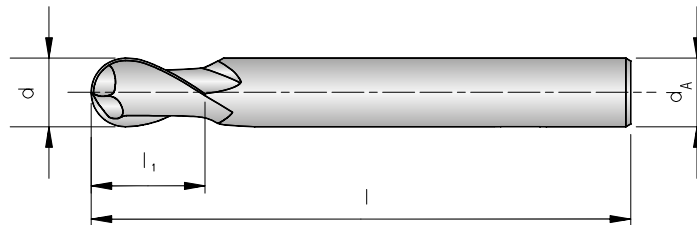

							PG 24
							beschichtet coated revêtu
Schaft DIN 6535HA Shank Tige	d -0,012	d <sub>A</sub> h6	l <sub>1</sub>	l	R ±0,005	0015	
AFX50321-001A	0,1	4	0,2	40	0,05	●	
AFX50321-002A	0,2	4	0,4	40	0,10	●	
AFX50321-003A	0,3	4	0,6	40	0,15	●	
AFX50321-004A	0,4	4	0,8	40	0,20	●	
AFX50321-005A	0,5	4	1,0	40	0,25	●	
AFX50321-006A	0,6	4	1,2	40	0,30	●	
AFX50321-007A	0,7	4	1,4	40	0,35	●	
AFX50321-008A	0,8	4	1,6	40	0,40	●	
AFX50321-009A	0,9	4	1,8	40	0,45	●	
AFX50321-010A	1,0	4	2,5	50	0,50	●	
AFX50321-010B	1,0	6	2,5	50	0,50	●	
AFX50321-010C	1,0	6	2,5	70	0,50	●	
AFX50321-012A	1,2	6	3,0	50	0,60	●	
AFX50321-015A	1,5	4	4,0	50	0,75	●	
AFX50321-015B	1,5	6	4,0	50	0,75	●	
AFX50321-015C	1,5	6	4,0	70	0,75	●	
AFX50321-020A	2,0	4	5,0	50	1,00	●	
AFX50321-020B	2,0	6	3,0	40	1,00	●	
AFX50321-020C	2,0	6	5,0	50	1,00	●	
AFX50321-020D	2,0	6	5,0	80	1,00	●	
AFX50321-025A	2,5	6	6,0	60	1,25	●	
AFX50321-025B	2,5	6	6,0	80	1,25	●	
AFX50321-030A	3,0	4	6,0	60	1,50	●	
AFX50321-030B	3,0	6	4,5	40	1,50	●	
AFX50321-030C	3,0	6	6,0	60	1,50	●	
AFX50321-030D	3,0	6	6,0	80	1,50	●	
AFX50321-030E	3,0	6	6,0	100	1,50	●	
AFX50321-040A	4,0	4	8,0	70	2,00	●	
AFX50321-040B	4,0	4	8,0	100	2,00	●	
AFX50321-040C	4,0	6	6,0	50	2,00	●	
AFX50321-040D	4,0	6	8,0	70	2,00	●	
AFX50321-040E	4,0	6	8,0	100	2,00	●	
AFX50321-040F	4,0	6	8,0	120	2,00	●	

AFX

Solid carbide ball-nose end-mill  
Fraise carbure monobloc hémisphérique

							PG 24
							beschichtet coated revêtu
Schaft DIN 6535HA Shank Tige	d -0,012	d <sub>A</sub> h6	l <sub>1</sub>	l	R ±0,005	S100	
AFX50321-045	4,5	6	9,0	80	2,25	●	
AFX50321-050A	5,0	6	7,5	60	2,50	●	
AFX50321-050B	5,0	6	10,0	80	2,50	●	

P	●
M	
K	●
N	
S	
H	●

● Hauptanwendung  
Main application  
Application principale

○ Nebenanwendung  
Secondary application  
Application secondaire

							PG 24
							beschichtet coated revêtu
Schaft DIN 6535HA Shank Tige	d -0,015	d <sub>A</sub> h6	l <sub>1</sub>	l	R ±0,010	S105	
AFX50321-060	6	6	9	50	3,0	●	
AFX50321-060A	6	6	9	60	3,0	●	
AFX50321-060B	6	6	9	80	3,0	●	
AFX50321-060C	6	6	12	90	3,0	●	
AFX50321-060D	6	6	12	130	3,0	●	
AFX50321-060E	6	6	12	150	3,0	●	
AFX50321-070A	7	8	14	90	3,5	●	
AFX50321-080A	8	8	12	50	4,0	●	
AFX50321-080B	8	8	12	60	4,0	●	
AFX50321-080C	8	8	12	80	4,0	●	
AFX50321-080D	8	8	12	90	4,0	●	
AFX50321-080E	8	8	14	100	4,0	●	
AFX50321-080F	8	8	14	150	4,0	●	
AFX50321-090	9	10	18	100	4,5	●	
AFX50321-100A	10	10	15	60	5,0	●	
AFX50321-100B	10	10	15	90	5,0	●	
AFX50321-100C	10	10	18	100	5,0	●	
AFX50321-100D	10	10	18	130	5,0	●	
AFX50321-100E	10	10	18	150	5,0	●	
AFX50321-100F	10	10	18	180	5,0	●	
AFX50321-110	11	12	20	100	5,5	●	
AFX50321-120A	12	12	18	80	6,0	●	
AFX50321-120B	12	12	18	100	6,0	●	
AFX50321-120C	12	12	22	110	6,0	●	
AFX50321-120D	12	12	22	130	6,0	●	
AFX50321-120E	12	12	22	150	6,0	●	
AFX50321-120F	12	12	22	200	6,0	●	
AFX50321-130A	13	12	24	100	6,5	●	
AFX50321-140A	14	14	26	100	7,0	●	
AFX50321-160A	16	16	24	100	8,0	●	

Solid carbide ball-nose end-mill  
Fraise carbure monobloc hémisphérique

							PG 24
							beschichtet coated revêtu
Schaft DIN 6535HA Shank Tige	d -0,015	d <sub>A</sub> h6	l <sub>1</sub>	l	R ±0,010	S100	
AFX50321-160B	16	16	30	150	8,0	●	
AFX50321-200A	20	20	30	100	10,0	●	
AFX50321-200B	20	20	38	150	10,0	●	

P	●
M	
K	●
N	
S	
H	●

● **Hauptanwendung**  
Main application  
Application principale

○ **Nebenanwendung**  
Secondary application  
Application secondaire

Solid carbide ball-nose end-mill  
Fraise carbure monobloc hémisphérique

## AFX52021-...

2 Schneiden, lange Ausführung (Schlitzfräsen) / 2 flutes, long design (Slotting) / 2 dents, version longue (fraise à rainier)

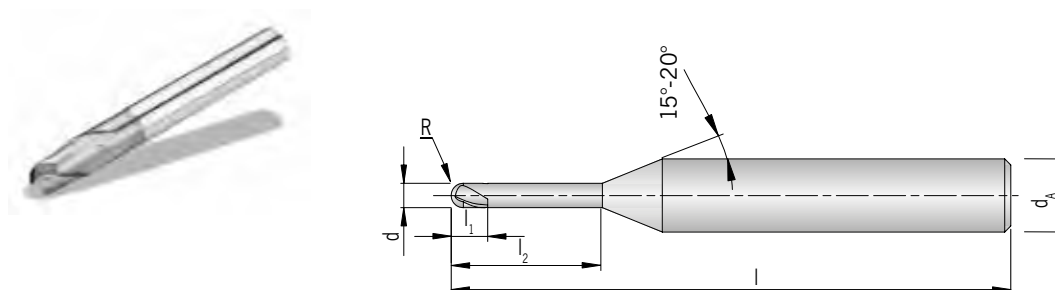

							PG 24
							beschichtet coated revêtu
Schaft DIN 6535HA Shank Tige	d -0,012	d <sub>A</sub> h6	l <sub>1</sub>	l <sub>2</sub>	l	R ±0,005	S100
AFX52021-002A	0,2	4	0,2	0,5	40	0,10	●
AFX52021-002B	0,2	4	0,2	1,0	40	0,10	●
AFX52021-002C	0,2	4	0,2	1,5	40	0,10	●
AFX52021-002D	0,2	4	0,2	3,0	40	0,10	●
AFX52021-003A	0,3	4	0,3	1,0	40	0,15	●
AFX52021-003B	0,3	4	0,3	1,5	40	0,15	●
AFX52021-003C	0,3	4	0,3	2,0	40	0,15	●
AFX52021-003D	0,3	4	0,3	3,0	40	0,15	●
AFX52021-004A	0,4	4	0,4	1,0	40	0,20	●
AFX52021-004B	0,4	4	0,4	1,5	40	0,20	●
AFX52021-004C	0,4	4	0,4	2,0	40	0,20	●
AFX52021-004D	0,4	4	0,4	3,0	40	0,20	●
AFX52021-004E	0,4	4	0,4	4,0	40	0,20	●
AFX52021-004F	0,4	4	0,4	5,0	40	0,20	●
AFX52021-004G	0,4	4	0,4	6,0	40	0,20	●
AFX52021-005A	0,5	4	0,5	1,0	45	0,25	●
AFX52021-005B	0,5	4	0,5	2,0	45	0,25	●
AFX52021-005C	0,5	4	0,5	3,0	45	0,25	●
AFX52021-005D	0,5	4	0,5	4,0	45	0,25	●
AFX52021-005E	0,5	4	0,5	5,0	45	0,25	●
AFX52021-005F	0,5	4	0,5	6,0	45	0,25	●
AFX52021-005G	0,5	4	0,5	8,0	45	0,25	●
AFX52021-005H	0,5	4	0,5	10,0	45	0,25	●
AFX52021-006A	0,6	4	0,6	1,0	45	0,30	●
AFX52021-006B	0,6	4	0,6	2,0	45	0,30	●
AFX52021-006C	0,6	4	0,6	3,0	45	0,30	●
AFX52021-006D	0,6	4	0,6	4,0	45	0,30	●
AFX52021-006E	0,6	4	0,6	5,0	45	0,30	●
AFX52021-006F	0,6	4	0,6	6,0	45	0,30	●
AFX52021-006G	0,6	4	0,6	8,0	45	0,30	●
AFX52021-006H	0,6	4	0,6	10,0	45	0,30	●
AFX52021-006I	0,6	4	0,6	12,0	45	0,30	●

AFX

Solid carbide ball-nose end-mill  
Fraise carbure monobloc hémisphérique

							PG 24
							beschichtet coated revêtu
Schaft DIN 6535HA Shank Tige	d -0,012	d <sub>A</sub> h6	l <sub>1</sub>	l <sub>2</sub>	l	R ±0,005	S100
AFX52021-007A	0,7	4	0,7	6,0	45	0,35	●
AFX52021-008A	0,8	4	0,8	2,0	45	0,40	●
AFX52021-008B	0,8	4	0,8	3,0	45	0,40	●
AFX52021-008C	0,8	4	0,8	4,0	45	0,40	●
AFX52021-008D	0,8	4	0,8	5,0	45	0,40	●
AFX52021-008E	0,8	4	0,8	6,0	45	0,40	●
AFX52021-008F	0,8	4	0,8	8,0	45	0,40	●
AFX52021-008G	0,8	4	0,8	10,0	45	0,40	●
AFX52021-010A	1,0	6	1,0	5,0	50	0,50	●
AFX52021-010B	1,0	6	1,0	6,0	50	0,50	●
AFX52021-010C	1,0	6	1,0	8,0	50	0,50	●
AFX52021-020A	2,0	6	2,0	8,0	50	1,00	●
AFX52021-020B	2,0	6	2,0	10,0	50	1,00	●
AFX52021-030A	3,0	6	3,0	8,0	50	1,50	●
AFX52021-030B	3,0	6	3,0	10,0	50	1,50	●
AFX52021-030C	3,0	6	3,0	12,0	50	1,50	●
AFX52021-030D	3,0	6	3,0	14,0	60	1,50	●
AFX52021-030E	3,0	6	3,0	16,0	60	1,50	●
AFX52021-030F	3,0	6	3,0	18,0	60	1,50	●
AFX52021-030G	3,0	6	3,0	20,0	60	1,50	●
AFX52021-030H	3,0	6	3,0	26,0	65	1,50	●
AFX52021-030I	3,0	6	3,0	30,0	70	1,50	●
AFX52021-030J	3,0	6	3,0	35,0	70	1,50	●
AFX52021-040A	4,0	6	4,0	10,0	50	2,00	●
AFX52021-040B	4,0	6	4,0	12,0	50	2,00	●
AFX52021-040C	4,0	6	4,0	14,0	60	2,00	●
AFX52021-040D	4,0	6	4,0	16,0	60	2,00	●
AFX52021-040E	4,0	6	4,0	18,0	60	2,00	●
AFX52021-040F	4,0	6	4,0	20,0	60	2,00	●
AFX52021-040G	4,0	6	4,0	26,0	65	2,00	●
AFX52021-040H	4,0	6	4,0	30,0	70	2,00	●
AFX52021-040I	4,0	6	4,0	35,0	70	2,00	●
AFX52021-040J	4,0	6	4,0	40,0	80	2,00	●
AFX52021-050A	5,0	6	6,0	30,0	70	2,50	●

P	●
M	
K	●
N	
S	
H	●

● Hauptanwendung  
Main application  
Application principale

○ Nebenanwendung  
Secondary application  
Application secondaire

Solid carbide ball-nose end-mill  
Fraise carbure monobloc hémisphérique

							PG 24
							beschichtet coated revêtu
Schaft DIN 6535HA Shank Tige	d -0,015	d <sub>A</sub> h6	l <sub>1</sub>	l <sub>2</sub>	l	R ±0,010	S100
AFX52021-060A	6	6	8	20	60	3	●
AFX52021-060B	6	6	8	30	60	3	●
AFX52021-080A	8	8	10	25	70	4	●
AFX52021-080B	8	8	14	35	100	4	●
AFX52021-100A	10	10	12	30	75	5	●
AFX52021-100B	10	10	18	30	100	5	●
AFX52021-100C	10	10	18	40	100	5	●
AFX52021-120A	12	12	14	32	80	6	●
AFX52021-120B	12	12	22	32	110	6	●

P	●
M	
K	●
N	
S	
H	●

● **Hauptanwendung**  
Main application  
Application principale

○ **Nebenanwendung**  
Secondary application  
Application secondaire



Solid carbide end-mill  
Fraise carbure monobloc à tige

## AFX50140-...

4 Schneiden / 4 flutes / 4 dents

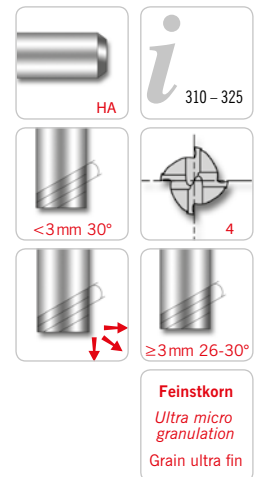
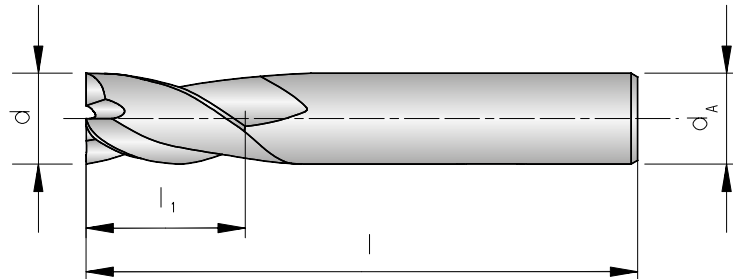

						PG 24
						beschichtet coated revêtu
Schaft DIN 6535HA Shank Tige	d -0,03	d <sub>A</sub> h6	l <sub>1</sub>	l		0015
AFX50140-010	1,0	6	2,5	50		●
AFX50140-015	1,5	6	4,0	50		●
AFX50140-020	2,0	6	6,0	50		●
AFX50140-025	2,5	6	7,0	50		●
AFX50140-030	3,0	6	8,0	50		●
AFX50140-035	3,5	6	10,0	50		●
AFX50140-040	4,0	6	10,0	50		●
AFX50140-045	4,5	6	14,0	50		●
AFX50140-050	5,0	6	15,0	60		●
AFX50140-055	5,5	6	15,0	60		●
AFX50140-060	6,0	6	15,0	60		●
AFX50140-065	6,5	8	18,0	60		●
AFX50140-070	7,0	8	20,0	60		●
AFX50140-075	7,5	8	20,0	60		●
AFX50140-080	8,0	8	20,0	70		●
AFX50140-085	8,5	10	22,0	70		●
AFX50140-090	9,0	10	22,0	70		●
AFX50140-095	9,5	10	24,0	70		●
AFX50140-100	10,0	10	25,0	75		●
AFX50140-105	10,5	12	26,0	75		●
AFX50140-110	11,0	12	30,0	75		●
AFX50140-115	11,5	12	30,0	80		●
AFX50140-120	12,0	12	30,0	80		●
AFX50140-130	13,0	12	35,0	100		●
AFX50140-140	14,0	14	35,0	100		●
AFX50140-160	16,0	16	40,0	100		●

AFX

Solid carbide end-mill

Fraise carbure monobloc à tige

						PG 24
						beschichtet coated revêtu
Schaft DIN 6535HA Shank Tige	d -0,03	d <sub>A</sub> h6	l <sub>1</sub>	l	S100	
AFX50140-180	18,0	18	45,0	100	●	
AFX50140-200	20,0	20	45,0	100	●	
AFX50140-250	25,0	25	50,0	120	●	

P	●
M	
K	●
N	
S	
H	●

- **Hauptanwendung**  
Main application  
Application principale
- **Nebenanwendung**  
Secondary application  
Application secondaire

Solid carbide end-mill  
Fraise carbure monobloc à tige

## AFX50041-...R...

4 Schneiden, lange Ausführung, mit Eckenradius / 4 flutes, long design, with corner radius / 4 dents, version longue, avec rayon d'angle

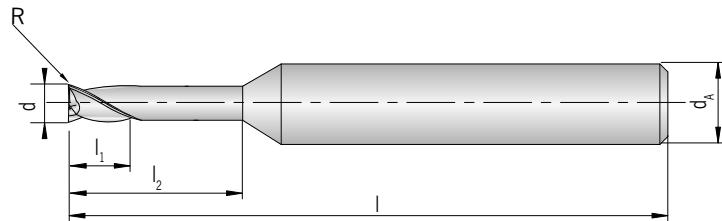
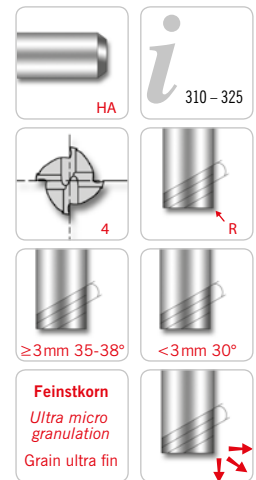

								PG 24
								beschichtet coated revêtu
Schaft DIN 6535HA Shank Tige	d -0,03	d <sub>A</sub> h6	l <sub>1</sub>	l <sub>2</sub>	l	R ± 0,02	S100	
AFX50041-010AR0,1	1,0	4	1,5	4	50	0,1	●	
AFX50041-010AR0,2	1,0	4	1,5	4	50	0,2	●	
AFX50041-010AR0,3	1,0	4	1,5	4	50	0,3	●	
AFX50041-010BR0,1	1,0	4	1,5	6	50	0,1	●	
AFX50041-010BR0,2	1,0	4	1,5	6	50	0,2	●	
AFX50041-010BR0,3	1,0	4	1,5	6	50	0,3	●	
AFX50041-010CR0,1	1,0	4	1,5	8	50	0,1	●	
AFX50041-010CR0,2	1,0	4	1,5	8	50	0,2	●	
AFX50041-010CR0,3	1,0	4	1,5	8	50	0,3	●	
AFX50041-012AR0,1	1,2	4	1,8	4	50	0,1	●	
AFX50041-012AR0,2	1,2	4	1,8	4	50	0,2	●	
AFX50041-012AR0,3	1,2	4	1,8	4	50	0,3	●	
AFX50041-012BR0,1	1,2	4	1,8	6	50	0,1	●	
AFX50041-012BR0,2	1,2	4	1,8	6	50	0,2	●	
AFX50041-012BR0,3	1,2	4	1,8	6	50	0,3	●	
AFX50041-012CR0,1	1,2	4	1,8	8	50	0,1	●	
AFX50041-012CR0,2	1,2	4	1,8	8	50	0,2	●	
AFX50041-012CR0,3	1,2	4	1,8	8	50	0,3	●	
AFX50041-015AR0,1	1,5	4	2,3	6	50	0,1	●	
AFX50041-015AR0,2	1,5	4	2,3	6	50	0,2	●	
AFX50041-015AR0,3	1,5	4	2,3	6	50	0,3	●	
AFX50041-015AR0,5	1,5	4	2,3	6	50	0,5	●	
AFX50041-015BR0,1	1,5	4	2,3	8	50	0,1	●	
AFX50041-015BR0,2	1,5	4	2,3	8	50	0,2	●	
AFX50041-015BR0,3	1,5	4	2,3	8	50	0,3	●	
AFX50041-015BR0,5	1,5	4	2,3	8	50	0,5	●	
AFX50041-015CR0,1	1,5	4	2,3	10	50	0,1	●	
AFX50041-015CR0,2	1,5	4	2,3	10	50	0,2	●	
AFX50041-015CR0,3	1,5	4	2,3	10	50	0,3	●	
AFX50041-015CR0,5	1,5	4	2,3	10	50	0,5	●	
AFX50041-015DR0,1	1,5	4	2,3	12	50	0,1	●	
AFX50041-015DR0,2	1,5	4	2,3	12	50	0,2	●	

PG 24

beschichtet  
coated  
revêtu

Schaft DIN 6535HA Shank Tige	d -0,03	d <sub>A</sub> h6	l <sub>1</sub>	l <sub>2</sub>	l	R ± 0,02	S100
AFX50041-015DR0,3	1,5	4	2,3	12	50	0,3	●
AFX50041-015DR0,5	1,5	4	2,3	12	50	0,5	●
AFX50041-020AR0,1	2,0	4	3,0	6	50	0,1	●
AFX50041-020AR0,2	2,0	4	3,0	6	50	0,2	●
AFX50041-020AR0,3	2,0	4	3,0	6	50	0,3	●
AFX50041-020AR0,5	2,0	4	3,0	6	50	0,5	●
AFX50041-020BR0,1	2,0	4	3,0	8	50	0,1	●
AFX50041-020BR0,2	2,0	4	3,0	8	50	0,2	●
AFX50041-020BR0,3	2,0	4	3,0	8	50	0,3	●
AFX50041-020BR0,5	2,0	4	3,0	8	50	0,5	●
AFX50041-020CR0,1	2,0	4	3,0	10	50	0,1	●
AFX50041-020CR0,2	2,0	4	3,0	10	50	0,2	●
AFX50041-020CR0,3	2,0	4	3,0	10	50	0,3	●
AFX50041-020CR0,5	2,0	4	3,0	10	50	0,5	●
AFX50041-020DR0,1	2,0	4	3,0	12	50	0,1	●
AFX50041-020DR0,2	2,0	4	3,0	12	50	0,2	●
AFX50041-020DR0,3	2,0	4	3,0	12	50	0,3	●
AFX50041-020DR0,5	2,0	4	3,0	12	50	0,5	●
AFX50041-030AR0,1	3,0	6	4,5	8	50	0,1	●
AFX50041-030AR0,2	3,0	6	4,5	10	50	0,2	●
AFX50041-030AR0,3	3,0	6	4,5	8	50	0,3	●
AFX50041-030AR0,5	3,0	6	4,5	8	60	0,5	●
AFX50041-030AR1,0	3,0	6	4,5	8	50	1,0	●
AFX50041-030BR0,1	3,0	6	4,5	10	50	0,1	●
AFX50041-030BR0,2	3,0	6	4,5	12	60	0,2	●
AFX50041-030BR0,3	3,0	6	4,5	10	60	0,3	●
AFX50041-030BR0,5	3,0	6	4,5	10	50	0,5	●
AFX50041-030BR1,0	3,0	6	4,5	10	50	1,0	●
AFX50041-030CR0,1	3,0	6	4,5	12	50	0,1	●
AFX50041-030CR0,2	3,0	6	4,5	16	60	0,2	●
AFX50041-030CR0,3	3,0	6	4,5	12	50	0,3	●
AFX50041-030CR0,5	3,0	6	4,5	12	50	0,5	●
AFX50041-030CR1,0	3,0	6	4,5	12	50	1,0	●
AFX50041-030DR0,1	3,0	6	4,5	16	60	0,1	●
AFX50041-030DR0,2	3,0	6	4,5	20	60	0,2	●
AFX50041-030DR0,3	3,0	6	4,5	16	60	0,3	●
AFX50041-030DR0,5	3,0	6	4,5	16	60	0,5	●
AFX50041-030DR1,0	3,0	6	4,5	16	60	1,0	●
AFX50041-030ER0,3	3,0	6	4,5	20	60	0,3	●
AFX50041-030ER0,5	3,0	6	4,5	20	60	0,5	●
AFX50041-030FR0,5	3,0	6	4,5	26	65	0,5	●
AFX50041-040AR0,1	4,0	6	6,0	10	50	0,1	●
AFX50041-040AR0,2	4,0	6	6,0	10	50	0,2	●
AFX50041-040AR0,3	4,0	6	6,0	10	50	0,3	●
AFX50041-040AR0,5	4,0	6	6,0	10	50	0,5	●
AFX50041-040AR1,0	4,0	6	6,0	10	50	1,0	●
AFX50041-040BR0,1	4,0	6	6,0	12	50	0,1	●
AFX50041-040BR0,2	4,0	6	6,0	12	50	0,2	●
AFX50041-040BR0,3	4,0	6	6,0	12	50	0,3	●
AFX50041-040BR0,5	4,0	6	6,0	12	50	0,5	●
AFX50041-040BR1,0	4,0	6	6,0	12	50	1,0	●
AFX50041-040CR0,1	4,0	6	6,0	16	60	0,1	●
AFX50041-040CR0,2	4,0	6	6,0	16	60	0,2	●
AFX50041-040CR0,3	4,0	6	6,0	16	60	0,3	●
AFX50041-040CR0,5	4,0	6	6,0	16	60	0,5	●
AFX50041-040CR1,0	4,0	6	6,0	16	60	1,0	●

PG 24

beschichtet  
coated  
revêtu

Schaft DIN 6535HA Shank Tige	d -0,03	d <sub>A</sub> h6	l <sub>1</sub>	l <sub>2</sub>	l	R ± 0,02	S100
AFX50041-040DR0,1	4,0	6	6,0	20	60	0,1	●
AFX50041-040DR0,2	4,0	6	6,0	20	60	0,2	●
AFX50041-040DR0,3	4,0	6	6,0	20	60	0,3	●
AFX50041-040DR0,5	4,0	6	6,0	20	60	0,5	●
AFX50041-040DR1,0	4,0	6	6,0	20	60	1,0	●
AFX50041-040ER0,2	4,0	6	6,0	26	65	0,2	●
AFX50041-040ER0,3	4,0	6	6,0	26	65	0,3	●
AFX50041-040ER0,5	4,0	6	6,0	26	65	0,5	●
AFX50041-040ER1,0	4,0	6	6,0	26	65	1,0	●
AFX50041-060AR0,3	6,0	6	9,0	20	60	0,3	●
AFX50041-060AR0,5	6,0	6	9,0	20	60	0,5	●
AFX50041-060AR1,0	6,0	6	9,0	20	60	1,0	●
AFX50041-080AR0,2	8,0	8	12,0	25	70	0,2	●
AFX50041-080AR0,3	8,0	8	12,0	25	70	0,3	●
AFX50041-080AR0,5	8,0	8	12,0	25	70	0,5	●
AFX50041-080AR1,0	8,0	8	12,0	25	70	1,0	●
AFX50041-080BR0,5	8,0	8	20,0	35	100	0,5	●
AFX50041-100AR0,3	10,0	10	15,0	30	75	0,3	●
AFX50041-100AR0,5	10,0	10	15,0	30	75	0,5	●
AFX50041-100AR1,0	10,0	10	15,0	30	75	1,0	●
AFX50041-100AR1,5	10,0	10	15,0	30	75	1,5	●
AFX50041-100BR0,5	10,0	10	25,0	40	100	0,5	●
AFX50041-120AR0,5	12,0	12	18,0	32	80	0,5	●
AFX50041-120AR1,0	12,0	12	18,0	32	80	1,0	●
AFX50041-120AR1,5	12,0	12	18,0	32	80	1,5	●
AFX50041-120AR2,0	12,0	12	18,0	32	80	2,0	●
AFX50041-120BR0,5	12,0	12	30,0	45	110	0,5	●
AFX50041-160AR0,5	16,0	16	20,0	35	100	0,5	●
AFX50041-160AR1,0	16,0	16	20,0	35	100	1,0	●
AFX50041-200AR0,5	20,0	20	25,0	40	100	0,5	●
AFX50041-200AR1,0	20,0	20	25,0	40	100	1,0	●

P	●
M	
K	●
N	
S	
H	●

● Hauptanwendung  
Main application  
Application principale

○ Nebenanwendung  
Secondary application  
Application secondaire



## AFX50741-...R...

4 Schneiden, lange Ausführung, mit Eckenradius / 4 flutes, long design, with corner radius / 4 dents, version longue, avec rayon d'angle

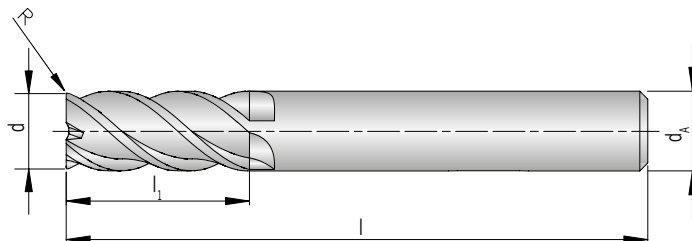
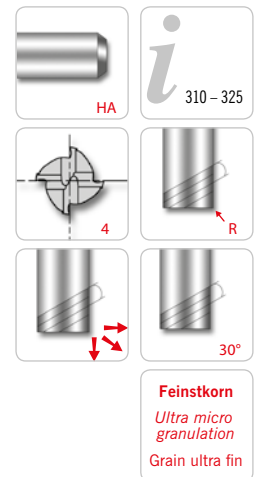

PG 24

beschichtet  
coated  
revêtu

Schaft DIN 6535HA Shank Tige	d -0,03	d <sub>A</sub> h6	l <sub>1</sub>	l	R ± 0,02	S100
AFX50741-010R0,1	1,0	6	2,5	50	0,1	●
AFX50741-015R0,2	1,5	6	4,0	50	0,2	●
AFX50741-020R0,1	2,0	6	6,0	50	0,1	●
AFX50741-020R0,2	2,0	6	6,0	50	0,2	●
AFX50741-025R0,2	2,5	6	7,0	60	0,2	●
AFX50741-030R0,2	3,0	6	8,0	60	0,2	●
AFX50741-030R0,3	3,0	6	8,0	60	0,3	●
AFX50741-030R0,5	3,0	6	8,0	60	0,5	●
AFX50741-040R0,2	4,0	6	10,0	70	0,2	●
AFX50741-040R0,3	4,0	6	10,0	70	0,3	●
AFX50741-040R0,5	4,0	6	10,0	70	0,5	●
AFX50741-040R1,0	4,0	6	10,0	70	1,0	●
AFX50741-050R0,3	5,0	6	13,0	90	0,3	●
AFX50741-050R0,5	5,0	6	13,0	90	0,5	●
AFX50741-060AR0,2	6,0	6	15,0	60	0,2	●
AFX50741-060BR0,2	6,0	6	15,0	90	0,2	●
AFX50741-060R0,3	6,0	6	15,0	90	0,3	●
AFX50741-060R0,5	6,0	6	15,0	90	0,5	●
AFX50741-060R1,0	6,0	6	15,0	90	1,0	●
AFX50741-080AR0,3	8,0	8	20,0	70	0,3	●
AFX50741-080AR0,5	8,0	8	20,0	70	0,5	●
AFX50741-080AR1,0	8,0	8	20,0	70	1,0	●
AFX50741-080BR0,3	8,0	8	20,0	100	0,3	●
AFX50741-080BR0,5	8,0	8	20,0	100	0,5	●
AFX50741-080BR1,0	8,0	8	20,0	100	1,0	●
AFX50741-080R0,2	8,0	8	20,0	100	0,2	●
AFX50741-080R1,5	8,0	8	20,0	100	1,5	●
AFX50741-080R2,0	8,0	8	20,0	100	2,0	●
AFX50741-100AR0,5	10,0	10	25,0	75	0,5	●
AFX50741-100BR0,5	10,0	10	25,0	100	0,5	●
AFX50741-100R0,3	10,0	10	25,0	100	0,3	●
AFX50741-100R1,0	10,0	10	25,0	100	1,0	●
AFX50741-100R1,5	10,0	10	25,0	100	1,5	●

AFX

							PG 24
							beschichtet coated revêtu
Schaft DIN 6535HA Shank Tige	d -0,03	d <sub>A</sub> h6	l <sub>1</sub>	l	R ± 0,02	0105	
AFX50741-100R2,0	10,0	10	25,0	100	2,0	●	
AFX50741-120AR0,5	12,0	12	30,0	80	0,5	●	
AFX50741-120AR1,0	12,0	12	30,0	80	1,0	●	
AFX50741-120BR0,5	12,0	12	30,0	110	0,5	●	
AFX50741-120R1,0	12,0	12	30,0	110	1,0	●	
AFX50741-120R1,5	12,0	12	30,0	110	1,5	●	
AFX50741-120R2,0	12,0	12	30,0	110	2,0	●	
AFX50741-160R0,5	16,0	16	32,0	150	0,5	●	
AFX50741-160R1,0	16,0	16	32,0	150	1,0	●	
AFX50741-160R1,5	16,0	16	32,0	150	1,5	●	
AFX50741-160R2,0	16,0	16	32,0	150	2,0	●	
AFX50741-200R1,0	20,0	20	38,0	150	1,0	●	
AFX50741-200R2,0	20,0	20	38,0	150	2,0	●	

P	●
M	
K	●
N	
S	
H	●

- **Hauptanwendung**  
Main application  
Application principale
- **Nebenanwendung**  
Secondary application  
Application secondaire

Solid carbide end-mill  
Fraise carbure monobloc à tige

## AFX50042-...

4 Schneiden / 4 flutes / 4 dents

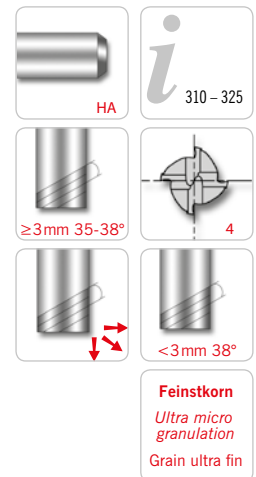
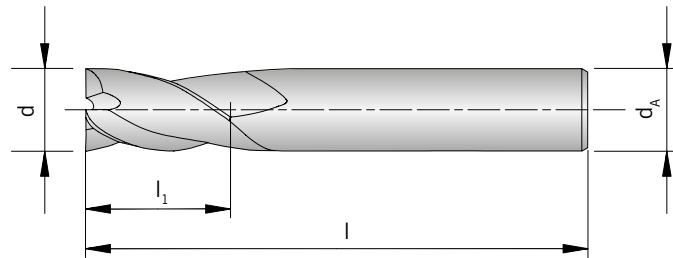

						PG 24
						beschichtet coated revêtu
Schaft DIN 6535HA Shank Tige	d -0,03	d <sub>A</sub> h6	l <sub>1</sub>	l		0015
AFX50042-010A	1,0	6	2,5	50	●	
AFX50042-012A	1,2	6	3,0	50	●	
AFX50042-015A	1,5	6	4,0	50	●	
AFX50042-020A	2,0	6	6,0	50	●	
AFX50042-025A	2,5	6	7,0	50	●	
AFX50042-030A	3,0	6	8,0	50	●	
AFX50042-040A	4,0	6	10,0	50	●	
AFX50042-050A	5,0	6	15,0	60	●	
AFX50042-060A	6,0	6	15,0	60	●	
AFX50042-060B	6,0	6	25,0	60	●	
AFX50042-080A	8,0	8	20,0	70	●	
AFX50042-100A	10,0	10	25,0	75	●	
AFX50042-120A	12,0	12	30,0	80	●	
AFX50042-120B	12,0	12	35,0	80	●	
AFX50042-160A	16,0	16	32,0	100	●	
AFX50042-200A	20,0	20	45,0	100	●	

P	●
M	●
K	●
N	●
S	●
H	●

● **Hauptanwendung**  
Main application  
Application principale

○ **Nebenanwendung**  
Secondary application  
Application secondaire



Solid carbide end-mill  
Fraise carbure monobloc à tige

## AFX50141-...

4 Schneiden, lange Ausführung / 4 flutes, long design / 4 dents, version longue

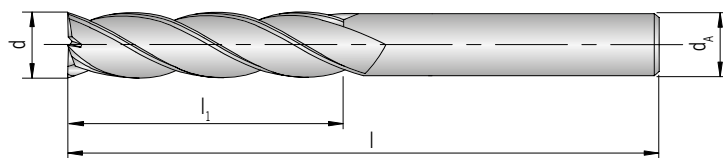

						PG 24
						beschichtet coated revêtu
Schaft DIN 6535HA Shank Tige	d -0,03	d <sub>A</sub> h6	l <sub>1</sub>	l		0015
AFX50141-010A	1,0	6	3	60		●
AFX50141-010B	1,0	6	4	60		●
AFX50141-010C	1,0	6	5	60		●
AFX50141-010D	1,0	6	6	60		●
AFX50141-015A	1,5	6	6	60		●
AFX50141-020A	2,0	6	8	60		●
AFX50141-020B	2,0	6	10	60		●
AFX50141-020C	2,0	6	12	60		●
AFX50141-020D	2,0	6	14	60		●
AFX50141-025A	2,5	6	10	60		●
AFX50141-025B	2,5	6	12	60		●
AFX50141-030A	3,0	6	10	70		●
AFX50141-030B	3,0	6	12	70		●
AFX50141-030C	3,0	6	16	70		●
AFX50141-030D	3,0	6	20	70		●
AFX50141-030E	3,0	6	26	70		●
AFX50141-030F	3,0	6	30	70		●
AFX50141-040A	4,0	6	12	70		●
AFX50141-040B	4,0	6	16	70		●
AFX50141-040C	4,0	6	20	70		●
AFX50141-040D	4,0	6	26	70		●
AFX50141-040E	4,0	6	30	70		●
AFX50141-050A	5,0	6	20	70		●
AFX50141-050B	5,0	6	25	70		●
AFX50141-050C	5,0	6	30	80		●
AFX50141-060A	6,0	6	15	60		●
AFX50141-060B	6,0	6	20	70		●
AFX50141-060C	6,0	6	20	90		●
AFX50141-060D	6,0	6	25	75		●
AFX50141-060E	6,0	6	30	80		●
AFX50141-060F	6,0	6	30	100		●
AFX50141-060G	6,0	6	35	90		●
AFX50141-060H	6,0	6	40	90		●

AFX

						PG 24
						beschichtet coated revêtu
Schaft DIN 6535HA Shank Tige	d -0,03	d <sub>A</sub> h6	l <sub>1</sub>	l	S100	
AFX50141-060I	6,0	6	40	120	●	
AFX50141-060J	6,0	6	45	150	●	
AFX50141-080A	8,0	8	25	80	●	
AFX50141-080B	8,0	8	30	80	●	
AFX50141-080C	8,0	8	35	80	●	
AFX50141-080D	8,0	8	40	90	●	
AFX50141-080E	8,0	8	45	100	●	
AFX50141-080F	8,0	8	50	100	●	
AFX50141-080G	8,0	8	50	150	●	
AFX50141-100A	10,0	10	30	80	●	
AFX50141-100B	10,0	10	30	100	●	
AFX50141-100C	10,0	10	35	90	●	
AFX50141-100D	10,0	10	40	90	●	
AFX50141-100E	10,0	10	45	100	●	
AFX50141-100F	10,0	10	50	100	●	
AFX50141-120A	12,0	12	35	90	●	
AFX50141-120B	12,0	12	40	100	●	
AFX50141-120C	12,0	12	45	130	●	
AFX50141-120D	12,0	12	50	100	●	
AFX50141-120E	12,0	12	55	110	●	
AFX50141-120F	12,0	12	60	110	●	
AFX50141-120G	12,0	12	60	150	●	
AFX50141-140A	14,0	16	50	110	●	
AFX50141-160B	16,0	16	50	110	●	
AFX50141-160C	16,0	16	60	120	●	
AFX50141-160D	16,0	16	70	130	●	
AFX50141-160E	16,0	16	70	150	●	
AFX50141-180A	18,0	20	50	120	●	
AFX50141-200A	20,0	20	60	130	●	
AFX50141-200B	20,0	20	90	200	●	
AFX50141-250A	25,0	25	90	150	●	

P	●
M	
K	●
N	
S	
H	●

● Hauptanwendung  
Main application  
Application principale

○ Nebenanwendung  
Secondary application  
Application secondaire

## AFX50142-...

4 Schneiden, extra lange Ausführung / 4 flutes, extra long design / 4 dents, version extra longue

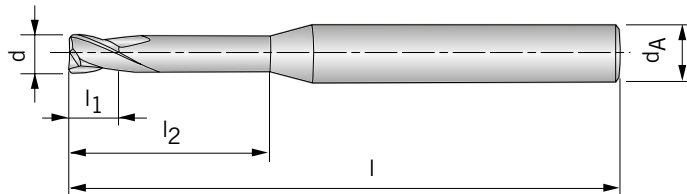

							PG 24
							beschichtet coated revêtu
Schaft DIN 6535HA Shank Tige	d -0,03	d <sub>A</sub> h6	l <sub>1</sub>	l <sub>2</sub>	l	S100	
AFX50142-010A	1,0	4	1,5	4	50	●	
AFX50142-010B	1,0	4	1,5	5	50	●	
AFX50142-010C	1,0	4	1,5	6	50	●	
AFX50142-010D	1,0	4	1,5	8	50	●	
AFX50142-015A	1,5	4	2,3	6	50	●	
AFX50142-015B	1,5	4	2,3	8	50	●	
AFX50142-015C	1,5	4	2,3	10	50	●	
AFX50142-015D	1,5	4	2,3	12	50	●	
AFX50142-015E	1,5	4	2,3	16	50	●	
AFX50142-020A	2,0	4	3,0	8	50	●	
AFX50142-020B	2,0	4	3,0	10	50	●	
AFX50142-020C	2,0	4	3,0	12	50	●	
AFX50142-020D	2,0	4	3,0	16	50	●	
AFX50142-030A	3,0	6	4,5	10	50	●	
AFX50142-030B	3,0	6	4,5	12	50	●	
AFX50142-030C	3,0	6	4,5	16	60	●	
AFX50142-030D	3,0	6	4,5	20	60	●	
AFX50142-030E	3,0	6	4,5	30	70	●	
AFX50142-040A	4,0	6	6,0	12	50	●	
AFX50142-040B	4,0	6	6,0	16	60	●	
AFX50142-040C	4,0	6	6,0	20	60	●	
AFX50142-040D	4,0	6	6,0	30	70	●	
AFX50142-040E	4,0	6	6,0	40	80	●	
AFX50142-050A	5,0	6	8,0	20	60	●	
AFX50142-050B	5,0	6	8,0	40	80	●	
AFX50142-060A	6,0	6	9,0	15	60	●	
AFX50142-060B	6,0	6	9,0	30	70	●	
AFX50142-080A	8,0	8	12,0	25	70	●	

AFX

							PG 24
							beschichtet coated revêtu
Schaft DIN 6535HA Shank Tige	d -0,03	d <sub>A</sub> h6	l <sub>1</sub>	l <sub>2</sub>	l	l100	
AFX50142-080B	8,0	8	12,0	42	100	●	
AFX50142-100A	10,0	10	15,0	30	75	●	
AFX50142-100B	10,0	10	15,0	45	100	●	
AFX50142-120A	12,0	12	20,0	35	80	●	
AFX50142-120B	12,0	12	20,0	50	110	●	

P	●
M	
K	●
N	
S	
H	●

- **Hauptanwendung**  
Main application  
Application principale
- **Nebenanwendung**  
Secondary application  
Application secondaire

Solid carbide end-mill  
Fraise carbure monobloc à tige

## AFX50260-...

6 Schneiden, kurze Ausführung / 6 flutes, short design / 6 dents, version courte

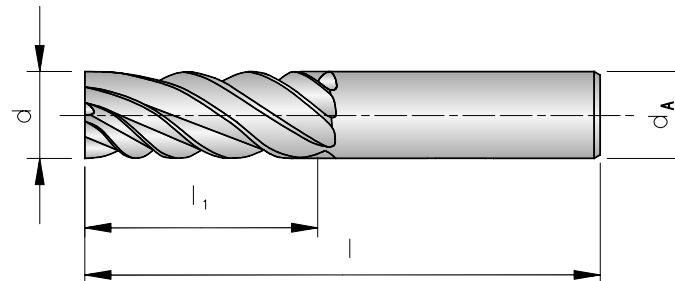

						PG 24
						beschichtet coated revêtu
Schaft DIN 6535HA Shank Tige	d -0,03	d <sub>A</sub> h6	l <sub>1</sub>	l	ST10	
AFX50260-060A	6	6	15	60	●	
AFX50260-060B	6	6	30	80	●	
AFX50260-080A	8	8	20	70	●	
AFX50260-080B	8	8	40	90	●	
AFX50260-100A	10	10	25	75	●	
AFX50260-100B	10	10	40	90	●	
AFX50260-120A	12	12	30	80	●	
AFX50260-120B	12	12	50	100	●	
AFX50260-120C	12	12	60	110	●	
AFX50260-160A	16	16	40	100	●	
AFX50260-160B	16	16	60	120	●	
AFX50260-200A	20	20	45	100	●	
AFX50260-200B	20	20	60	120	●	

P	●
M	
K	●
N	
S	
H	●

● Hauptanwendung  
Main application  
Application principale

○ Nebenanwendung  
Secondary application  
Application secondaire

AFX

Ausführung AFX / Design AFX / Modèle AFX

MATERIAL MATERIAL MATÉRIAU	Unlegierter Stahl / Non-alloyed steel / Acier non allié						Legierter Stahl / Alloy steel / Acier allié					Gehärteter Stahl / Hardened steel / Acier trempé				
Härte / Hardness / Dureté	~ HRC 35						HRC 35 ~ HRC 45					HRC 45 ~ HRC 55				
Zugfestigkeit / Strength / Résistance à la traction	~ 1100 N/mm <sup>2</sup>						1110 ~ 1500 N/mm <sup>2</sup>					1500 ~ 2000 N/mm <sup>2</sup>				
d	I <sub>2</sub>	a <sub>p</sub>	n	f <sub>z</sub>	v <sub>f</sub>	v <sub>c</sub>	a <sub>p</sub>	n	f <sub>z</sub>	v <sub>f</sub>	v <sub>c</sub>	a <sub>p</sub>	n	f <sub>z</sub>	v <sub>f</sub>	v <sub>c</sub>
(mm)	(mm)	(mm)	(U/min)	(mm)	(mm/min)	(m/min)	(mm)	(U/min)	(mm)	(mm/min)	(m/min)	(mm)	(U/min)	(mm)	(mm/min)	(m/min)
0,2	1,0	0,028	50.000	0,002	170	31	0,021	34.500	0,001	75	22	0,017	21.150	0,001	45	13
0,3	1,0	0,042	50.000	0,002	200	47	0,032	32.000	0,001	85	30	0,025	20.000	0,001	50	19
0,3	2,0	0,024	45.000	0,002	160	42	0,018	28.800	0,001	70	27	0,014	18.000	0,001	40	17
0,4	1,0	0,080	50.000	0,002	200	63	0,060	32.000	0,001	85	40	0,048	20.000	0,001	50	25
0,4	1,5	0,056	50.000	0,002	200	63	0,042	32.000	0,001	85	40	0,034	20.000	0,001	50	25
0,4	2,0	0,056	50.000	0,002	200	63	0,042	32.000	0,001	85	40	0,034	20.000	0,001	50	25
0,4	2,5	0,032	45.000	0,002	160	57	0,024	28.800	0,001	70	36	0,019	18.000	0,001	40	23
0,5	1,0	0,100	43.000	0,003	220	68	0,075	28.000	0,002	95	44	0,060	17.100	0,002	60	27
0,5	1,5	0,100	43.000	0,003	220	68	0,075	28.000	0,002	95	44	0,060	17.100	0,002	60	27
0,5	2,0	0,070	43.000	0,003	220	68	0,053	28.000	0,002	95	44	0,042	17.100	0,002	60	27
0,5	3,0	0,040	38.700	0,002	180	61	0,030	25.200	0,001	75	40	0,024	15.390	0,002	50	24
0,5	4,0	0,040	38.700	0,002	180	61	0,030	25.200	0,001	75	40	0,024	15.390	0,002	50	24
0,6	2,0	0,084	36.400	0,003	250	69	0,063	24.000	0,002	110	45	0,050	14.500	0,002	65	27
0,6	3,0	0,084	36.400	0,003	250	69	0,063	24.000	0,002	110	45	0,050	14.500	0,002	65	27
0,6	4,0	0,048	32.760	0,003	205	62	0,036	21.600	0,002	90	41	0,029	13.050	0,002	55	25
0,6	6,0	0,030	32.760	0,003	205	62	0,023	21.600	0,002	90	41	0,018	13.050	0,002	55	25
0,8	2,0	0,160	36.400	0,003	250	91	0,120	24.000	0,002	110	60	0,096	14.500	0,002	65	36
0,8	4,0	0,112	36.400	0,003	250	91	0,084	24.000	0,002	110	60	0,067	14.500	0,002	65	36
0,8	6,0	0,064	32.760	0,003	205	82	0,048	21.600	0,002	90	54	0,038	13.050	0,002	55	33
0,8	8,0	0,040	32.760	0,003	205	82	0,030	21.600	0,002	90	54	0,024	13.050	0,002	55	33
1,0	3,0	0,200	33.100	0,004	280	104	0,150	21.600	0,003	120	68	0,120	13.200	0,003	70	41
1,0	4,0	0,140	33.100	0,004	280	104	0,105	21.600	0,003	120	68	0,084	13.200	0,003	70	41
1,0	6,0	0,080	29.790	0,004	225	94	0,060	19.440	0,002	95	61	0,048	11.880	0,002	55	37
1,0	8,0	0,080	29.790	0,004	225	94	0,060	19.440	0,002	95	61	0,048	11.880	0,002	55	37
1,0	10,0	0,050	29.790	0,004	225	94	0,038	19.440	0,002	95	61	0,030	11.880	0,002	55	37
1,0	12,0	0,050	26.480	0,003	180	83	0,038	17.280	0,002	75	54	0,030	10.560	0,002	45	33
1,2	4,0	0,168	29.750	0,005	290	112	0,126	18.900	0,003	125	71	0,101	11.700	0,003	70	44
1,2	6,0	0,168	29.750	0,005	290	112	0,126	18.900	0,003	125	71	0,101	11.700	0,003	70	44
1,2	8,0	0,096	26.780	0,004	235	101	0,072	17.010	0,003	100	64	0,058	10.530	0,003	55	40
1,2	10,0	0,060	26.780	0,004	235	101	0,045	17.010	0,003	100	64	0,036	10.530	0,003	55	40
2,0	6,0	0,400	21.600	0,007	310	136	0,300	13.800	0,005	140	87	0,240	8.640	0,005	80	54
2,0	8,0	0,280	21.600	0,007	310	136	0,210	13.800	0,005	140	87	0,168	8.640	0,005	80	54
2,0	10,0	0,280	21.600	0,007	310	136	0,210	13.800	0,005	140	87	0,168	8.640	0,005	80	54
2,0	12,0	0,160	19.440	0,006	250	122	0,120	12.420	0,005	115	78	0,096	7.780	0,004	65	49
2,0	14,0	0,160	19.440	0,006	250	122	0,120	12.420	0,005	115	78	0,096	7.780	0,004	65	49
2,0	16,0	0,160	19.440	0,006	250	122	0,120	12.420	0,005	115	78	0,096	7.780	0,004	65	49
3,0	8,0	0,600	15.900	0,010	330	150	0,450	10.300	0,008	160	97	0,360	6.300	0,006	80	59
3,0	10,0	0,420	15.900	0,010	330	150	0,315	10.300	0,008	160	97	0,252	6.300	0,006	80	59
3,0	12,0	0,420	15.900	0,010	330	150	0,315	10.300	0,008	160	97	0,252	6.300	0,006	80	59
3,0	14,0	0,420	15.900	0,010	330	150	0,315	10.300	0,008	160	97	0,252	6.300	0,006	80	59
3,0	16,0	0,240	14.310	0,009	265	135	0,180	9.270	0,007	130	87	0,144	5.670	0,006	65	53
3,0	20,0	0,240	14.310	0,009	265	135	0,180	9.270	0,007	130	87	0,144	5.670	0,006	65	53
3,0	26,0	0,150	14.310	0,009	265	135	0,113	9.270	0,007	130	87	0,090	5.670	0,006	65	53
4,0	10,0	0,800	12.800	0,016	400	161	0,600	8.200	0,012	200	103	0,480	5.150	0,009	95	65
4,0	12,0	0,800	12.800	0,016	400	161	0,600	8.200	0,012	200	103	0,480	5.150	0,009	95	65
4,0	16,0	0,560	12.800	0,016	400	161	0,420	8.200	0,012	200	103	0,336	5.150	0,009	95	65
4,0	20,0	0,560	12.800	0,016	400	161	0,420	8.200	0,012	200	103	0,336	5.150	0,009	95	65
4,0	26,0	0,320	11.520	0,014	325	145	0,240	7.380	0,011	160	93	0,192	4.640	0,008	78	58
4,0	30,0	0,320	11.520	0,014	325	145	0,240	7.380	0,011	160	93	0,192	4.640	0,008	78	58
6,0	20,0	0,840	9.500	0,032	600	179	0,630	6.000	0,025	300	113	0,504	3.930	0,018	140	74
6,0	30,0	0,840	9.500	0,032	600	179	0,630	6.000	0,025	300	113	0,504	3.930	0,018	140	74
8,0	25,0	1,120	7.200	0,044	640	181	0,840	4.550	0,033	300	114	0,672	3.020	0,023	140	76
10,0	30,0	2,000	6.000	0,053	640	188	1,500	4.000	0,038	300	126	1,200	2.420	0,029	140	76
12,0	32,0	2,400	5.000	0,050	500	188	1,800	3.340	0,040	270	126	1,440	2.000	0,030	120	75
16,0	35,0	3,200	3.720	0,060	450	187	2,400	2.520	0,042	210	127	1,920	1.540	0,031	95	77
20,0	40,0	4,000	3.000	0,055	330	188	3,000	1.950	0,036	140	123	2,400	1.200	0,029	70	75

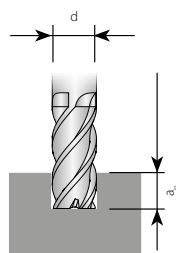

Die Tabellenwerte sind Richtwerte. Es kann notwendig sein, die Werte den jeweiligen Bearbeitungsbedingungen anzupassen.

The recommended cutting data are only approximate values. It may be necessary to adjust them to each individual machining application.

Les valeurs du tableau sont indicatives. Il peut être nécessaire de les adapter aux conditions d'usage respectives.

AFX

Ausführung AFX / Design AFX / Modèle AFX

MATERIAL MATERIAL MATÉRIAU	Unlegierter Stahl / Non-alloyed steel / Acier non allié				Legierter Stahl / Alloy steel				Legierter Stahl / Alloy steel / Acier allié			
	Legierter Stahl / Alloy steel / Acier allié				Hochwarmfester Stahl / Heat resistant steel				Hochwarmfester Stahl / Heat resistant steel / Acier réfractaire			
	Gusseisen / Cast iron / Fonte				Hochwarmfester Stahl / Heat resistant steel				Hochwarmfester Stahl / Heat resistant steel / Acier réfractaire			
Härte / Hardness / Dureté Zugfestigkeit / Strength / Résistance à la traction	~ HRc 35 ~ 1100 N/mm <sup>2</sup>				HRc 35 ~ HRc 45 1110 ~ 1500 N/mm <sup>2</sup>				HRc 45 ~ HRc 55 1500 ~ 2000 N/mm <sup>2</sup>			
d (mm)	n (U/min)	f <sub>z</sub> (mm)	v <sub>f</sub> (mm/min)	v <sub>c</sub> (m/min)	n (U/min)	f <sub>z</sub> (mm)	v <sub>f</sub> (mm/min)	v <sub>c</sub> (m/min)	n (U/min)	f <sub>z</sub> (mm)	v <sub>f</sub> (mm/min)	v <sub>c</sub> (m/min)
0,1	42.000	0,001	80	13	25.200	0,001	47	8	16.800	0,001	16	5
0,2	42.000	0,001	85	26	25.200	0,001	50	16	16.800	0,001	17	11
0,3	39.000	0,001	90	37	23.400	0,001	54	22	15.600	0,001	18	15
0,4	39.000	0,001	95	49	23.400	0,001	57	29	15.600	0,001	19	20
0,5	36.000	0,002	110	57	21.600	0,002	66	34	14.400	0,001	22	23
0,6	32.000	0,002	125	60	19.200	0,002	76	36	12.800	0,001	25	24
0,7	28.000	0,003	140	62	16.800	0,003	85	37	11.200	0,001	28	25
0,8	25.000	0,003	155	63	15.000	0,003	95	38	10.000	0,002	32	25
0,9	23.500	0,004	165	66	14.100	0,003	98	40	9.400	0,002	33	27
1,0	21.500	0,004	170	68	12.900	0,004	101	41	8.600	0,002	34	27
1,2	18.000	0,005	175	68	10.800	0,005	104	41	7.200	0,002	35	27
1,5	15.000	0,006	180	71	9.000	0,006	107	42	6.000	0,003	36	28
2,0	11.560	0,009	200	73	7.560	0,008	125	48	5.040	0,004	37	32
2,5	10.240	0,010	210	80	6.560	0,010	135	52	4.200	0,005	39	33
3,0	8.920	0,012	220	84	5.560	0,013	145	52	3.360	0,006	42	32
3,5	8.240	0,016	270	91	5.090	0,017	170	56	3.150	0,007	42	35
4,0	7.560	0,021	315	95	4.620	0,021	190	58	2.940	0,007	42	37
4,5	6.930	0,023	325	98	4.200	0,023	195	59	2.630	0,009	47	37
5,0	6.300	0,027	335	99	3.780	0,026	200	59	2.320	0,011	53	36
5,5	5.930	0,030	350	102	3.570	0,030	215	62	2.160	0,013	55	37
6,0	5.560	0,033	370	105	3.360	0,034	230	63	2.000	0,015	58	38
6,5	5.220	0,036	375	107	3.150	0,036	225	64	1.920	0,016	63	39
7,0	4.880	0,039	385	107	2.940	0,037	220	65	1.840	0,018	68	40
7,5	4.540	0,043	390	107	2.730	0,039	215	64	1.760	0,021	74	41
8,0	4.200	0,048	400	106	2.520	0,042	210	63	1.680	0,024	79	42
8,5	3.965	0,049	385	106	2.390	0,042	200	64	1.600	0,023	74	43
9,0	3.730	0,050	375	105	2.260	0,042	190	64	1.520	0,022	68	43
9,5	3.495	0,051	355	104	2.130	0,042	180	64	1.440	0,022	63	43
10,0	3.260	0,053	345	102	2.000	0,043	170	63	1.360	0,023	63	43
10,5	3.130	0,053	330	103	1.920	0,042	160	63	1.310	0,023	61	43
11,0	3.000	0,053	320	104	1.840	0,041	150	64	1.260	0,023	58	44
11,5	2.870	0,053	305	104	1.760	0,040	140	64	1.210	0,024	58	44
12,0	2.740	0,054	295	103	1.680	0,040	135	63	1.160	0,025	58	44
13,0	2.605	0,054	280	106	1.600	0,041	130	65	1.095	0,025	55	45
14,0	2.470	0,054	265	109	1.520	0,041	125	67	1.030	0,024	49	45
15,0	2.335	0,052	245	110	1.440	0,042	120	68	965	0,023	45	45
16,0	2.200	0,052	230	111	1.360	0,042	115	68	900	0,023	42	45
18,0	1.940	0,053	205	110	1.210	0,041	100	68	790	0,023	37	45
20,0	1.680	0,054	180	106	1.060	0,040	84	67	680	0,024	32	43

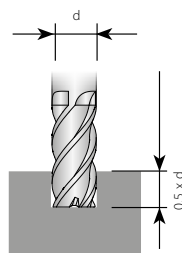

< ø 1 mm - 0,15 x d  
> ø 1 mm - 0,2 x d  
> ø 3mm - 0,5 x d

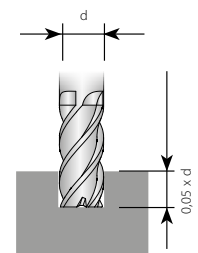

< ø 1 mm - 0,02 x d  
> ø 1mm - 0,05 x d

Die Tabellenwerte sind Richtwerte. Es kann notwendig sein, die Werte den jeweiligen Bearbeitungsbedingungen anzupassen.

The recommended cutting data are only approximate values. It may be necessary to adjust them to each individual machining application.

Les valeurs du tableau sont indicatives. Il peut être nécessaire de les adapter aux conditions d'usage respectives.

Ausführung AFX / Design AFX / Modèle AFX

MATERIAL MATERIAU		Unlegierter Stahl / Non-alloyed steel / Acier non allié Legierter Stahl / Alloy steel / Acier allié Gusseisen / Cast iron / Fonte					Legierter Stahl / Alloy steel / Acier allié Hochwarmfester Stahl / Heat resistant steel / Acier réfractaire					Gehärteter Stahl / Hardened steel / Acier trempé			
Härte / Hardness / Dureté Zugfestigkeit / Strength / Résistance à la traction		~ HRc 35 ~ 1100 N/mm <sup>2</sup>					HRc 35 ~ HRc 45 1110 ~ 1500 N/mm <sup>2</sup>					HRc 45 ~ HRc 55 1500 ~ 2000 N/mm <sup>2</sup>			
d	l <sub>1</sub>	n	f <sub>z</sub>	v <sub>f</sub>	v <sub>c</sub>	n	f <sub>z</sub>	v <sub>f</sub>	v <sub>c</sub>	n	f <sub>z</sub>	v <sub>f</sub>	v <sub>c</sub>		
(mm)	(mm)	(U/min)	(mm)	(mm/min)	(m/min)	(U/min)	(mm)	(mm/min)	(m/min)	(U/min)	(mm)	(mm/min)	(m/min)		
1,0	3	16.000	0,002	70	50	12.800	0,002	60	40	8.000	0,002	30	25		
1,0	4	16.000	0,002	70	50	12.800	0,002	60	40	8.000	0,002	30	25		
1,0	6	14.400	0,002	55	45	11.520	0,002	50	36	7.200	0,002	25	23		
1,0	8	14.400	0,002	50	45	11.520	0,002	45	36	7.200	0,002	20	23		
1,0	10	14.400	0,002	50	45	11.520	0,002	45	36	7.200	0,002	20	23		
1,5	6	11.200	0,004	80	53	8.960	0,004	70	42	5.600	0,003	30	26		
1,5	8	10.080	0,003	70	48	8.060	0,004	60	38	5.040	0,003	30	24		
1,5	10	10.080	0,003	65	48	8.060	0,003	55	38	5.040	0,002	25	24		
1,5	12	10.080	0,003	60	48	8.060	0,003	50	38	5.040	0,002	25	24		
1,5	16	8.960	0,003	45	42	7.170	0,003	40	34	4.480	0,002	20	21		
2,0	8	9.070	0,005	85	57	7.260	0,005	70	46	4.540	0,004	35	29		
2,0	10	9.070	0,005	85	57	7.260	0,005	70	46	4.540	0,004	35	29		
2,0	12	8.160	0,004	70	51	6.530	0,005	60	41	4.090	0,004	30	26		
2,0	16	8.160	0,004	60	51	6.530	0,004	50	41	4.090	0,003	25	26		
2,5	10	7.700	0,006	95	60	6.200	0,006	80	49	3.850	0,005	40	30		
2,5	16	6.930	0,005	75	54	5.580	0,006	65	44	3.470	0,004	30	27		
3,0	10	6.350	0,008	100	60	5.150	0,008	85	49	3.170	0,006	40	30		
3,0	12	6.350	0,008	100	60	5.150	0,008	85	49	3.170	0,006	40	30		
3,0	16	5.720	0,008	90	54	4.640	0,008	75	44	2.850	0,007	40	27		
3,0	20	5.720	0,007	80	54	4.640	0,008	70	44	2.850	0,006	35	27		
3,0	26	5.720	0,006	70	54	4.640	0,006	60	44	2.850	0,005	30	27		
4,0	12	5.150	0,012	120	65	4.100	0,012	100	52	2.580	0,010	50	32		
4,0	16	5.150	0,012	120	65	4.100	0,012	100	52	2.580	0,010	50	32		
4,0	20	5.150	0,012	120	65	4.100	0,012	100	52	2.580	0,010	50	32		
4,0	26	4.640	0,010	95	58	3.690	0,012	85	46	2.320	0,009	40	29		
4,0	30	4.640	0,010	95	58	3.690	0,012	85	46	2.320	0,009	40	29		
5,0	20	4.400	0,017	150	69	3.480	0,018	125	55	2.280	0,012	55	36		
5,0	25	4.400	0,017	150	69	3.480	0,018	125	55	2.280	0,012	55	36		
5,0	30	3.960	0,015	120	62	3.130	0,016	100	49	2.050	0,011	45	32		
5,0	40	3.960	0,014	110	62	3.130	0,014	90	49	2.050	0,010	40	32		
6,0	15	3.800	0,024	180	72	3.050	0,025	150	57	1.970	0,018	70	37		
6,0	20	3.800	0,024	180	72	3.050	0,025	150	57	1.970	0,018	70	37		
6,0	25	3.800	0,024	180	72	3.050	0,025	150	57	1.970	0,018	70	37		
6,0	30	3.800	0,020	155	72	3.050	0,021	130	57	1.970	0,015	60	37		
6,0	35	3.420	0,020	140	64	2.750	0,021	115	52	1.770	0,016	55	33		
6,0	40	3.420	0,018	120	64	2.750	0,018	100	52	1.770	0,014	50	33		
6,0	45	3.420	0,018	120	64	2.750	0,018	100	52	1.770	0,014	50	33		
8,0	25	2.880	0,033	190	72	2.280	0,033	150	57	1.510	0,023	70	38		
8,0	30	2.880	0,033	190	72	2.280	0,033	150	57	1.510	0,023	70	38		
8,0	35	2.880	0,033	190	72	2.280	0,033	150	57	1.510	0,023	70	38		
8,0	40	2.880	0,028	160	72	2.280	0,027	125	57	1.510	0,020	60	38		
8,0	45	2.590	0,028	145	65	2.050	0,028	115	52	1.360	0,020	55	34		
8,0	50	2.590	0,025	130	65	2.050	0,024	100	52	1.360	0,018	50	34		
10,0	30	2.450	0,039	190	77	2.000	0,038	150	63	1.210	0,029	70	38		
10,0	35	2.450	0,039	190	77	2.000	0,038	150	63	1.210	0,029	70	38		
10,0	40	2.450	0,039	190	77	2.000	0,038	150	63	1.210	0,029	70	38		
10,0	45	2.450	0,033	160	77	2.000	0,031	125	63	1.210	0,025	60	38		
10,0	50	2.450	0,033	160	77	2.000	0,031	125	63	1.210	0,025	60	38		
10,0	60	2.210	0,029	130	69	1.800	0,028	100	57	1.090	0,023	50	34		
12,0	35	2.000	0,038	150	75	1.670	0,040	135	63	1.010	0,027	55	38		
12,0	40	2.000	0,038	150	75	1.670	0,040	135	63	1.010	0,027	55	38		
12,0	45	2.000	0,033	130	75	1.670	0,034	115	63	1.010	0,022	45	38		
12,0	50	2.000	0,033	130	75	1.670	0,034	115	63	1.010	0,022	45	38		
12,0	55	2.000	0,033	130	75	1.670	0,034	115	63	1.010	0,022	45	38		
12,0	60	2.000	0,028	110	75	1.670	0,030	110	63	1.010	0,020	40	38		
14,0	50	1.850	0,034	125	81	1.480	0,034	100	65	910	0,025	45	40		
16,0	40	1.700	0,041	140	85	1.280	0,041	105	64	800	0,031	50	40		
16,0	50	1.700	0,041	140	85	1.280	0,041	105	64	800	0,031	50	40		
18,0	50	1.450	0,041	120	82	1.120	0,040	90	63	700	0,029	40	40		
20,0	90	1.220	0,031	75	77	950	0,029	55	60	600	0,021	25	38		
20,0	110	1.100	0,032	70	69	860	0,029	50	45	540	0,023	25	34		

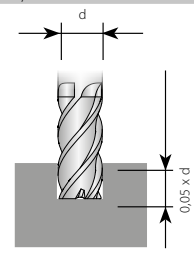
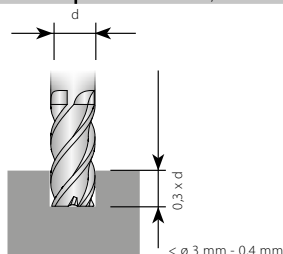

Die Tabellenwerte sind Richtwerte. Es kann notwendig sein, die Werte den jeweiligen Bearbeitungsumständen anzupassen.

The recommended cutting data are only approximate values. It may be necessary to adjust them to each individual machining application.

Les valeurs du tableau sont indicatives. Il peut être nécessaire de les adapter aux conditions d'usinage respectives.



Ausführung AFX / Design AFX / Modèle AFX

MATERIAL MATERIAL MATÉRIAU	Unlegierter Stahl / Non-alloyed steel Legierter Stahl / Alloy steel Gusseisen / Cast iron				Legierter Stahl / Alloy steel / Acier allié Hochwarmfester Stahl / Heat resistant steel / Acier réfractaire				Gehärteter Stahl / Hardened steel / Acier trempé				
	~ HRc 35 ~ 1100 N/mm <sup>2</sup>				HRc 35 ~ HRc 45 1110 ~ 1500 N/mm <sup>2</sup>				HRc 45 ~ HRc 55 1500 ~ 2000 N/mm <sup>2</sup>				
Härte / Hardness / Dureté Zugfestigkeit / Strength / Résistance à la traction	d (mm)	n (U/min)	f <sub>z</sub> (mm)	v <sub>f</sub> (mm/min)	v <sub>c</sub> (m/min)	n (U/min)	f <sub>z</sub> (mm)	v <sub>f</sub> (mm/min)	v <sub>c</sub> (m/min)	n (U/min)	f <sub>z</sub> (mm)	v <sub>f</sub> (mm/min)	v <sub>c</sub> (m/min)
<b>1,0</b>		27.600	0,004	240	87	18.000	0,003	100	57	11.000	0,003	60	35
<b>1,5</b>		22.000	0,006	250	104	13.500	0,004	110	64	8.500	0,004	60	40
<b>2,0</b>		18.000	0,007	260	113	11.560	0,005	120	73	7.200	0,005	70	45
<b>3,0</b>		13.240	0,011	280	125	8.560	0,008	140	81	5.280	0,007	70	50
<b>4,0</b>		10.720	0,016	340	135	6.820	0,012	170	86	4.300	0,009	80	54
<b>5,0</b>		9.160	0,023	420	144	5.800	0,017	200	91	3.800	0,013	100	60
<b>6,0</b>		7.900	0,032	500	149	5.040	0,025	250	95	3.280	0,018	120	62
<b>8,0</b>		6.000	0,045	540	151	3.800	0,033	250	96	2.520	0,024	120	63
<b>10,0</b>		5.040	0,054	540	158	3.280	0,038	250	103	2.020	0,030	120	63
<b>12,0</b>		4.120	0,051	420	155	2.780	0,041	230	105	1.680	0,030	100	63
<b>16,0</b>		3.100	0,058	360	156	2.100	0,040	170	106	1.280	0,031	80	64
<b>20,0</b>		2.520	0,056	280	158	1.640	0,037	120	103	1.000	0,030	60	63

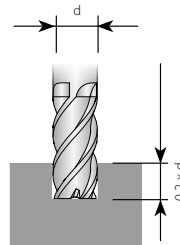

Die Tabellenwerte sind Richtwerte. Es kann notwendig sein, die Werte den jeweiligen Bearbeitungsumständen anzupassen.

The recommended cutting data are only approximate values. It may be necessary to adjust them to each individual machining application.

Les valeurs du tableau sont indicatives. Il peut être nécessaire de les adapter aux conditions d'usinage respectives.

Ausführung AFX / Design AFX / Modèle AFX

MATERIAL MATERIAL MATÉRIAU		Unlegierter Stahl / Non-alloyed steel / Acier non allié					Legierter Stahl / Alloy steel / Acier allié Hochwärmfester Stahl / Heat resistant steel / Acier réfractaire					Gehärteter Stahl / Hardened steel / Acier trempé				
		Legierter Stahl / Alloy steel / Acier allié Gusseisen / Cast iron / Fonte					HRC 35 ~ HRC 45 1110 ~ 1500 N/mm <sup>2</sup>					HRC 45 ~ HRC 55 1500 ~ 2000 N/mm <sup>2</sup>				
Härte / Hardness / Dureté		~ HRC 35 ~ 1100 N/mm <sup>2</sup>														
Zugfestigkeit / Strength / Résistance à la traction																
d (mm)	l <sub>z</sub> (mm)	a <sub>p</sub> (mm)	n (U/min)	f <sub>z</sub> (mm)	v <sub>f</sub> (mm/min)	v <sub>c</sub> (m/min)	a <sub>p</sub> (mm)	n (U/min)	f <sub>z</sub> (mm)	v <sub>f</sub> (mm/min)	v <sub>c</sub> (m/min)	a <sub>p</sub> (mm)	n (U/min)	f <sub>z</sub> (mm)	v <sub>f</sub> (mm/min)	v <sub>c</sub> (m/min)
0,2	1,0	0,013	38.500	0,005	380	24	0,010	36.300	0,004	270	23	0,007	32.100	0,003	200	20
0,3	1,5	0,019	34.200	0,006	390	32	0,015	32.300	0,004	270	30	0,011	28.500	0,004	230	27
0,3	2,0	0,011	30.780	0,005	315	29	0,008	29.070	0,004	220	27	0,006	25.650	0,004	185	24
0,4	1,0	0,036	27.400	0,010	540	34	0,028	25.800	0,007	380	32	0,020	22.800	0,006	280	29
0,4	1,5	0,025	27.400	0,010	540	34	0,020	25.800	0,007	380	32	0,014	22.800	0,006	280	29
0,4	2,0	0,025	27.400	0,010	540	34	0,020	25.800	0,007	380	32	0,014	22.800	0,006	280	29
0,4	3,0	0,014	24.660	0,009	435	31	0,011	23.220	0,007	310	29	0,008	20.520	0,005	225	26
0,4	4,0	0,009	24.660	0,009	435	31	0,007	23.220	0,007	310	29	0,005	20.520	0,005	225	26
0,4	5,0	0,009	21.920	0,008	345	28	0,007	20.640	0,006	245	26	0,005	18.240	0,005	180	23
0,5	2,0	0,032	27.400	0,010	540	43	0,025	25.800	0,008	425	41	0,018	22.800	0,006	285	36
0,5	3,0	0,018	24.660	0,009	435	39	0,014	23.220	0,007	345	36	0,010	20.520	0,006	230	32
0,5	4,0	0,018	24.660	0,009	435	39	0,014	23.220	0,007	345	36	0,010	20.520	0,006	230	32
0,5	5,0	0,011	24.660	0,009	435	39	0,009	23.220	0,007	345	36	0,006	20.520	0,006	230	32
0,5	6,0	0,011	21.920	0,008	345	34	0,009	20.640	0,007	270	32	0,006	18.240	0,005	180	29
0,6	2,0	0,038	27.400	0,014	775	52	0,029	25.800	0,011	545	49	0,021	22.800	0,009	405	43
0,6	3,0	0,038	27.400	0,014	775	52	0,029	25.800	0,011	545	49	0,021	22.800	0,009	405	43
0,6	4,0	0,022	24.660	0,013	630	46	0,017	23.220	0,009	440	44	0,012	20.520	0,008	330	39
0,6	5,0	0,014	24.660	0,013	630	46	0,011	23.220	0,009	440	44	0,008	20.520	0,008	330	39
0,6	6,0	0,014	24.660	0,013	630	46	0,011	23.220	0,009	440	44	0,008	20.520	0,008	330	39
0,6	8,0	0,008	21.920	0,011	495	41	0,006	20.640	0,008	350	39	0,005	18.240	0,007	260	34
0,6	10,0	0,005	16.440	0,010	325	31	0,004	15.480	0,007	230	29	0,003	13.680	0,006	170	26
0,8	2,0	0,072	27.400	0,014	775	69	0,056	25.800	0,012	605	65	0,040	22.800	0,010	450	57
0,8	3,0	0,050	27.400	0,014	775	69	0,039	25.800	0,012	605	65	0,028	22.800	0,010	450	57
0,8	4,0	0,050	27.400	0,014	775	69	0,039	25.800	0,012	605	65	0,028	22.800	0,010	450	57
0,8	5,0	0,029	24.660	0,013	630	62	0,022	23.220	0,011	490	58	0,016	20.520	0,009	365	52
0,8	6,0	0,029	24.660	0,013	630	62	0,022	23.220	0,011	490	58	0,016	20.520	0,009	365	52
0,8	8,0	0,018	24.660	0,013	630	62	0,014	23.220	0,011	490	58	0,010	20.520	0,009	365	52
0,8	10,0	0,018	21.920	0,011	495	55	0,014	20.640	0,009	385	52	0,010	18.240	0,008	290	46
1,0	3,0	0,090	24.600	0,021	1045	77	0,070	23.300	0,019	890	73	0,050	20.500	0,016	665	64
1,0	4,0	0,063	24.600	0,021	1045	77	0,049	23.300	0,019	890	73	0,035	20.500	0,016	665	64
1,0	5,0	0,063	24.600	0,021	1045	77	0,049	23.300	0,019	890	73	0,035	20.500	0,016	665	64
1,0	6,0	0,036	22.140	0,019	845	70	0,028	20.970	0,017	720	66	0,020	18.450	0,015	540	58
1,0	8,0	0,036	22.140	0,019	845	70	0,028	20.970	0,017	720	66	0,020	18.450	0,015	540	58
1,0	10,0	0,023	22.140	0,019	845	70	0,018	20.970	0,017	720	66	0,013	18.450	0,015	540	58
1,0	12,0	0,023	19.680	0,017	670	62	0,018	18.640	0,015	570	59	0,013	16.400	0,013	425	52
1,0	14,0	0,014	19.680	0,017	670	62	0,011	18.640	0,015	570	59	0,008	16.400	0,013	425	52
1,0	16,0	0,014	14.760	0,015	440	46	0,011	13.980	0,013	375	44	0,008	12.300	0,011	280	39
1,0	20,0	0,009	14.760	0,015	440	46	0,007	13.980	0,013	375	44	0,005	12.300	0,011	280	39
1,2	6,0	0,076	21.900	0,021	930	83	0,059	20.700	0,017	720	78	0,042	18.200	0,013	485	69
1,2	8,0	0,043	19.710	0,019	755	74	0,034	18.630	0,016	585	70	0,024	16.380	0,012	395	62
1,2	10,0	0,027	19.710	0,019	755	74	0,021	18.630	0,016	585	70	0,015	16.380	0,012	395	62
1,4	6,0	0,088	19.200	0,021	815	84	0,069	18.100	0,016	570	80	0,049	16.000	0,013	425	70
1,4	8,0	0,050	17.280	0,019	660	76	0,039	16.290	0,014	460	72	0,028	14.400	0,012	345	63
1,5	4,0	0,135	19.200	0,024	905	90	0,105	18.100	0,018	635	85	0,075	16.000	0,015	475	75
1,5	6,0	0,095	19.200	0,024	905	90	0,074	18.100	0,018	635	85	0,053	16.000	0,015	475	75
1,5	8,0	0,054	17.280	0,021	735	81	0,042	16.290	0,016	515	77	0,030	14.400	0,013	385	68
1,5	10,0	0,054	17.280	0,021	735	81	0,042	16.290	0,016	515	77	0,030	14.400	0,013	385	68
1,5	12,0	0,054	17.280	0,021	735	81	0,042	16.290	0,016	515	77	0,030	14.400	0,013	385	68
1,5	14,0	0,034	17.280	0,021	735	81	0,026	16.290	0,016	515	77	0,019	14.400	0,013	385	68
1,5	16,0	0,034	15.360	0,019	580	72	0,026	14.480	0,014	405	68	0,019	12.800	0,012	305	60
1,5	20,0	0,020	15.360	0,019	580	72	0,016	14.480	0,014	405	68	0,011	12.800	0,012	305	60

Die Tabellenwerte sind Richtwerte. Es kann notwendig sein, die Werte den jeweiligen Bearbeitungsbedingungen anzupassen.

The recommended cutting data are only approximate values. It may be necessary to adjust them to each individual machining application.

Les valeurs du tableau sont indicatives. Il peut être nécessaire de les adapter aux conditions d'usage respectives.

AFX

Recommended cutting data feed tables

Tableaux des avances valeurs de coupe recommandées

Ausführung AFX / Design AFX / Modèle AFX

MATERIAL MATERIAU		Unlegierter Stahl / Non-alloyed steel / Acier non allié Legierter Stahl / Alloy steel / Acier allié Gusseisen / Cast iron / Fonte					Legierter Stahl / Alloy steel / Acier allié Hochwärmfester Stahl / Heat resistant steel / Acier réfractaire					Gehärteter Stahl / Hardened steel / Acier trempé				
Härte / Hardness / Dureté		~ HRc 35 ~ 1100 N/mm <sup>2</sup>					HRc 35 ~ HRc 45 1110 ~ 1500 N/mm <sup>2</sup>					HRc 45 ~ HRc 55 1500 ~ 2000 N/mm <sup>2</sup>				
Zugfestigkeit / Strength / Résistance à la traction		a <sub>p</sub>	n	f <sub>z</sub>	v <sub>f</sub>	v <sub>c</sub>	a <sub>p</sub>	n	f <sub>z</sub>	v <sub>f</sub>	v <sub>c</sub>	a <sub>p</sub>	n	f <sub>z</sub>	v <sub>f</sub>	v <sub>c</sub>
d	l <sub>z</sub>	(mm)	(mm)	(mm)	(mm/min)	(m/min)	(mm)	(U/min)	(mm)	(mm/min)	(m/min)	(mm)	(U/min)	(mm)	(mm/min)	(m/min)
1,8	8,0	0,113	17.800	0,024	840	101	0,088	16.800	0,019	655	95	0,063	14.800	0,017	490	84
1,8	10,0	0,065	16.020	0,021	680	91	0,050	15.120	0,018	530	86	0,036	13.320	0,015	395	75
1,8	12,0	0,065	16.020	0,021	680	91	0,050	15.120	0,018	530	86	0,036	13.320	0,015	395	75
2,0	6,0	0,180	14.400	0,028	820	90	0,140	13.600	0,023	620	85	0,100	12.000	0,020	475	75
2,0	8,0	0,126	14.400	0,028	820	90	0,098	13.600	0,023	620	85	0,070	12.000	0,020	475	75
2,0	10,0	0,126	14.400	0,028	820	90	0,098	13.600	0,023	620	85	0,070	12.000	0,020	475	75
2,0	12,0	0,072	12.960	0,026	665	81	0,056	12.240	0,020	500	77	0,040	10.800	0,018	385	68
2,0	14,0	0,072	12.960	0,026	665	81	0,056	12.240	0,020	500	77	0,040	10.800	0,018	385	68
2,0	16,0	0,072	12.960	0,026	665	81	0,056	12.240	0,020	500	77	0,040	10.800	0,018	385	68
2,0	20,0	0,045	12.960	0,026	665	81	0,035	12.240	0,020	500	77	0,025	10.800	0,018	385	68
2,5	8,0	0,158	12.300	0,039	970	97	0,123	11.600	0,029	680	91	0,088	10.300	0,025	510	81
2,5	12,0	0,158	12.300	0,039	970	97	0,123	11.600	0,029	680	91	0,088	10.300	0,025	510	81
2,5	16,0	0,090	11.070	0,035	785	87	0,070	10.440	0,026	550	82	0,050	9.270	0,022	415	73
2,5	20,0	0,090	11.070	0,035	785	87	0,070	10.440	0,026	550	82	0,050	9.270	0,022	415	73
3,0	8,0	0,270	10.900	0,039	860	103	0,210	10.300	0,029	605	97	0,150	6.600	0,034	450	62
3,0	10,0	0,189	10.900	0,039	860	103	0,147	10.300	0,029	605	97	0,105	6.600	0,034	450	62
3,0	12,0	0,189	10.900	0,039	860	103	0,147	10.300	0,029	605	97	0,105	6.600	0,034	450	62
3,0	14,0	0,189	10.900	0,039	860	103	0,147	10.300	0,029	605	97	0,105	6.600	0,034	450	62
3,0	16,0	0,108	9.810	0,035	695	92	0,084	9.270	0,026	490	87	0,060	5.940	0,031	365	56
3,0	18,0	0,108	9.810	0,035	695	92	0,084	9.270	0,026	490	87	0,060	5.940	0,031	365	56
3,0	20,0	0,108	9.810	0,035	695	92	0,084	9.270	0,026	490	87	0,060	5.940	0,031	365	56
3,0	26,0	0,068	9.810	0,035	695	92	0,053	9.270	0,026	490	87	0,038	5.940	0,031	365	56
4,0	10,0	0,360	8.000	0,081	1300	101	0,280	7.600	0,076	1160	96	0,200	6.700	0,057	770	84
4,0	12,0	0,360	8.000	0,081	1300	101	0,280	7.600	0,076	1160	96	0,200	6.700	0,057	770	84
4,0	16,0	0,252	8.000	0,081	1300	101	0,196	7.600	0,076	1160	96	0,140	6.700	0,057	770	84
4,0	18,0	0,252	8.000	0,081	1300	101	0,196	7.600	0,076	1160	96	0,140	6.700	0,057	770	84
4,0	20,0	0,252	8.000	0,081	1300	101	0,196	7.600	0,076	1160	96	0,140	6.700	0,057	770	84
4,0	26,0	0,144	7.200	0,073	1055	90	0,112	6.840	0,069	940	86	0,080	6.030	0,052	625	76
4,0	30,0	0,144	7.200	0,073	1055	90	0,112	6.840	0,069	940	86	0,080	6.030	0,052	625	76
5,0	20,0	0,315	6.400	0,090	1155	101	0,245	6.100	0,074	900	96	0,175	5.400	0,056	605	85
5,0	30,0	0,180	5.760	0,081	935	90	0,140	5.790	0,066	730	86	0,100	4.860	0,050	490	76
5,0	35,0	0,180	5.760	0,081	935	90	0,140	5.790	0,066	730	86	0,100	4.860	0,050	490	76
5,0	40,0	0,180	5.760	0,081	935	90	0,140	5.790	0,066	730	86	0,100	4.860	0,050	490	76
5,0	50,0	0,113	5.760	0,081	935	90	0,088	5.790	0,066	730	86	0,063	4.860	0,050	490	76
6,0	15,0	0,540	5.300	0,100	1055	100	0,420	5.000	0,082	820	94	0,300	4.400	0,063	550	83
6,0	20,0	0,378	5.300	0,100	1055	100	0,294	5.000	0,082	820	94	0,210	4.400	0,063	550	83
6,0	30,0	0,378	5.300	0,100	1055	100	0,294	5.000	0,082	820	94	0,210	4.400	0,063	550	83
8,0	25,0	0,504	4.000	0,119	950	101	0,392	3.800	0,099	750	96	0,280	3.300	0,076	500	83
10,0	30,0	0,900	3.200	0,141	900	101	0,700	3.050	0,111	680	96	0,500	2.630	0,076	400	83
10,0	45,0	0,630	3.200	0,141	900	101	0,490	3.050	0,111	680	96	0,350	2.630	0,076	400	83
12,0	35,0	1,080	2.650	0,151	800	100	0,840	2.520	0,119	600	95	0,600	2.180	0,080	350	82
12,0	50,0	0,756	2.650	0,151	800	100	0,588	2.520	0,119	600	95	0,420	2.180	0,080	350	82

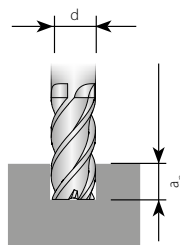

Schnitttiefe in einem Durchgang  
Depth of cut in one pass

Die Tabellenwerte sind Richtwerte. Es kann notwendig sein, die Werte den jeweiligen Bearbeitungsumständen anzupassen.

The recommended cutting data are only approximate values. It may be necessary to adjust them to each individual machining application.

Les valeurs du tableau sont indicatives. Il peut être nécessaire de les adapter aux conditions d'usage respectives.

Ausführung AFX / Design AFX / Modèle AFX

MATERIAL MATERIAL MATÉRIAU		Unlegierter Stahl / Non-alloyed steel / Acier non allié				Legierter Stahl / Alloy steel / Acier allié				Gehärteter Stahl / Hardened steel / Acier trempé			
		Legierter Stahl / Alloy steel / Acier allié				Hochwarmfester Stahl / Heat resistant steel / Acier réfractaire							
Härte / Hardness / Dureté		~ HRC 35				HRc 35 ~ HRc 45				HRc 45 ~ HRc 55			
Zugfestigkeit / Strength / Résistance à la traction		~ 1100 N/mm <sup>2</sup>				1110 ~ 1500 N/mm <sup>2</sup>				1500 ~ 2000 N/mm <sup>2</sup>			
d	R	n	f <sub>z</sub>	v <sub>f</sub>	v <sub>c</sub>	n	f <sub>z</sub>	v <sub>f</sub>	v <sub>c</sub>	n	f <sub>z</sub>	v <sub>f</sub>	v <sub>c</sub>
(mm)	(mm)	(U/min)	(mm)	(mm/min)	(m/min)	(U/min)	(mm)	(mm/min)	(m/min)	(U/min)	(mm)	(mm/min)	(m/min)
0,1	0,05	40.000	0,007	550	13	40.000	0,006	500	13	33.000	0,006	400	10
0,2	0,1	30.000	0,012	720	19	30.000	0,011	630	19	27.000	0,011	575	17
0,3	0,15	30.000	0,015	900	28	30.000	0,014	810	28	27.000	0,013	720	25
0,4	0,2	30.000	0,019	1140	38	30.000	0,017	1020	38	27.000	0,017	900	34
0,5	0,25	30.000	0,024	1440	47	30.000	0,021	1260	47	27.000	0,021	1140	42
0,6	0,3	30.000	0,029	1740	57	30.000	0,025	1500	57	27.000	0,024	1320	51
0,7	0,35	30.000	0,034	2040	66	30.000	0,029	1740	66	27.000	0,029	1560	59
0,8	0,4	30.000	0,039	2340	75	30.000	0,033	1980	75	27.000	0,033	1800	68
0,9	0,45	30.000	0,044	2610	85	30.000	0,038	2250	85	27.000	0,038	2040	76
1,0	0,5	30.000	0,048	2880	94	30.000	0,042	2520	94	27.000	0,042	2280	85
1,2	0,6	30.000	0,051	3060	113	28.800	0,045	2580	109	25.800	0,045	2310	97
1,5	0,75	30.000	0,054	3240	141	28.800	0,047	2700	136	25.800	0,047	2400	122
2,0	1,0	29.820	0,057	3420	187	28.680	0,050	2880	180	24.000	0,050	2400	151
2,5	1,25	23.800	0,074	3510	187	22.900	0,066	3030	180	19.200	0,063	2400	151
3,0	1,5	19.860	0,091	3600	187	19.080	0,083	3180	180	16.000	0,075	2400	151
4,0	2,0	14.900	0,121	3600	187	14.340	0,111	3180	180	12.000	0,100	2400	151
5,0	2,5	11.160	0,156	3480	175	10.680	0,138	2940	168	9.000	0,125	2250	141
6,0	3,0	8.340	0,174	2910	157	8.040	0,153	2460	152	6.600	0,141	1860	124
7,0	3,5	7.220	0,184	2650	159	6.960	0,159	2220	153	5.800	0,147	1700	128
8,0	4,0	6.660	0,189	2520	167	6.420	0,164	2100	161	5.400	0,150	1620	136
9,0	4,5	5.940	0,195	2320	168	5.700	0,170	1940	161	4.800	0,156	1500	136
10,0	5,0	5.580	0,199	2220	175	5.340	0,174	1860	168	4.500	0,160	1440	141
11,0	5,5	4.875	0,205	1995	168	4.670	0,180	1680	161	3.930	0,164	1290	136
12,0	6,0	4.170	0,212	1770	157	4.000	0,188	1500	151	3.360	0,170	1140	127
13,0	6,5	3.960	0,218	1725	162	3.800	0,197	1500	155	3.200	0,173	1110	131
14,0	7,0	3.750	0,224	1680	165	3.600	0,208	1500	158	3.030	0,178	1080	133
16,0	8,0	3.340	0,238	1590	168	3.210	0,206	1320	161	2.700	0,189	1020	136
20,0	10,0	2.670	0,264	1410	168	2.580	0,227	1170	162	2.160	0,208	900	136

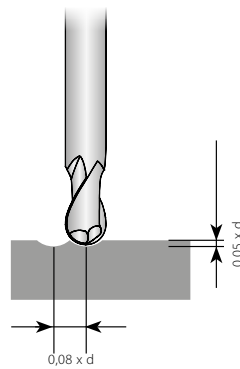

Die Tabellenwerte sind Richtwerte. Es kann notwendig sein, die Werte den jeweiligen Bearbeitungsbedingungen anzupassen.

The recommended cutting data are only approximate values. It may be necessary to adjust them to each individual machining application.

Les valeurs du tableau sont indicatives. Il peut être nécessaire de les adapter aux conditions d'usage respectives.

### Ausführung AFX / Design AFX / Modèle AFX

MATERIAL MATERIAL MATÉRIAU		Unlegierter Stahl / Non-alloyed steel / Acier non allié					Legierter Stahl / Alloy steel / Acier allié					Gehärteter Stahl / Hardened steel / Acier trempé				
Härte / Hardness / Dureté		~ HRC 35					HRC 35 ~ HRC 45					HRC 45 ~ HRC 55				
Zugfestigkeit / Strength / Résistance à la traction		~ 1100 N/mm <sup>2</sup>					1110 ~ 1500 N/mm <sup>2</sup>					1500 ~ 2000 N/mm <sup>2</sup>				
d (mm)	l <sub>2</sub> (mm)	a <sub>p</sub> (mm)	n (U/min)	f <sub>z</sub> (mm)	v <sub>f</sub> (mm/min)	v <sub>c</sub> (m/min)	a <sub>p</sub> (mm)	n (U/min)	f <sub>z</sub> (mm)	v <sub>f</sub> (mm/min)	v <sub>c</sub> (m/min)	a <sub>p</sub> (mm)	n (U/min)	f <sub>z</sub> (mm)	v <sub>f</sub> (mm/min)	v <sub>c</sub> (m/min)
0,2	0,5	0,018	50.000	0,003	335	31	0,014	50.000	0,003	310	31	0,010	43.200	0,003	260	27
0,2	1,0	0,013	50.000	0,003	335	31	0,010	50.000	0,003	310	31	0,007	43.200	0,003	260	27
0,2	1,5	0,007	45.000	0,003	270	28	0,006	45.000	0,003	250	28	0,004	38.880	0,003	210	24
0,2	3,0	0,003	45.000	0,003	270	28	0,003	45.000	0,003	250	28	0,002	38.880	0,003	210	24
0,3	1,0	0,019	50.000	0,005	475	47	0,015	50.000	0,004	430	47	0,011	42.800	0,004	365	40
0,3	1,5	0,019	50.000	0,005	475	47	0,015	50.000	0,004	430	47	0,011	42.800	0,004	365	40
0,3	2,0	0,011	45.000	0,004	385	42	0,008	45.000	0,004	350	42	0,006	38.520	0,004	295	36
0,3	3,0	0,007	45.000	0,004	385	42	0,005	45.000	0,004	350	42	0,004	38.520	0,004	295	36
0,4	1,0	0,036	41.000	0,006	490	52	0,028	38.800	0,005	425	49	0,020	34.200	0,005	340	43
0,4	1,5	0,025	41.000	0,006	490	52	0,020	38.800	0,005	425	49	0,014	34.200	0,005	340	43
0,4	2,0	0,025	41.000	0,006	490	52	0,020	38.800	0,005	425	49	0,014	34.200	0,005	340	43
0,4	3,0	0,014	36.900	0,005	395	46	0,011	34.920	0,005	345	44	0,008	30.780	0,004	275	39
0,4	4,0	0,009	36.900	0,005	395	46	0,007	34.920	0,005	345	44	0,005	30.780	0,004	275	39
0,4	5,0	0,009	32.800	0,005	315	41	0,007	31.040	0,004	270	39	0,005	27.360	0,004	220	34
0,4	6,0	0,005	32.800	0,005	315	41	0,004	31.040	0,004	270	39	0,003	27.360	0,004	220	34
0,5	1,0	0,045	34.200	0,010	685	54	0,035	32.300	0,009	580	51	0,025	28.500	0,009	515	45
0,5	2,0	0,032	34.200	0,010	685	54	0,025	32.300	0,009	580	51	0,018	28.500	0,009	515	45
0,5	3,0	0,018	30.780	0,009	555	48	0,014	29.070	0,008	470	46	0,010	25.650	0,008	415	40
0,5	4,0	0,018	30.780	0,009	555	48	0,014	29.070	0,008	470	46	0,010	25.650	0,008	415	40
0,5	5,0	0,011	30.780	0,009	555	48	0,009	29.070	0,008	470	46	0,006	25.650	0,008	415	40
0,5	6,0	0,011	27.360	0,008	440	43	0,009	25.840	0,007	370	41	0,006	22.800	0,007	330	36
0,5	8,0	0,007	20.520	0,007	290	32	0,005	19.380	0,006	245	30	0,004	17.100	0,006	215	27
0,5	10,0	0,005	20.520	0,007	290	32	0,004	19.380	0,006	245	30	0,003	17.100	0,006	215	27
0,6	1,0	0,038	34.200	0,015	1025	64	0,029	32.300	0,013	840	61	0,021	28.500	0,012	685	54
0,6	2,0	0,038	34.200	0,015	1025	64	0,029	32.300	0,013	840	61	0,021	28.500	0,012	685	54
0,6	3,0	0,038	34.200	0,015	1025	64	0,029	32.300	0,013	840	61	0,021	28.500	0,012	685	54
0,6	4,0	0,022	30.780	0,013	830	58	0,017	29.070	0,012	680	55	0,012	25.650	0,011	555	48
0,6	5,0	0,014	30.780	0,013	830	58	0,011	29.070	0,012	680	55	0,008	25.650	0,011	555	48
0,6	6,0	0,014	30.780	0,013	830	58	0,011	29.070	0,012	680	55	0,008	25.650	0,011	555	48
0,6	8,0	0,008	27.360	0,012	655	52	0,006	25.840	0,010	540	49	0,005	22.800	0,010	440	43
0,6	10,0	0,005	20.520	0,010	430	39	0,004	19.380	0,009	355	37	0,003	17.100	0,008	290	32
0,6	12,0	0,005	20.520	0,010	430	39	0,004	19.380	0,009	355	37	0,003	17.100	0,008	290	32
0,7	6,0	0,016	30.780	0,015	915	68	0,012	29.070	0,013	755	64	0,009	25.650	0,012	620	56
0,8	2,0	0,072	34.200	0,018	1230	86	0,056	32.300	0,016	1035	81	0,040	28.500	0,015	855	72
0,8	3,0	0,050	34.200	0,018	1230	86	0,039	32.300	0,016	1035	81	0,028	28.500	0,015	855	72
0,8	4,0	0,050	34.200	0,018	1230	86	0,039	32.300	0,016	1035	81	0,028	28.500	0,015	855	72
0,8	5,0	0,029	30.780	0,016	995	77	0,022	29.070	0,014	840	73	0,016	25.650	0,014	695	64
0,8	6,0	0,029	30.780	0,016	995	77	0,022	29.070	0,014	840	73	0,016	25.650	0,014	695	64
0,8	8,0	0,018	30.780	0,016	995	77	0,014	29.070	0,014	840	73	0,010	25.650	0,014	695	64
0,8	10,0	0,018	27.360	0,014	785	69	0,014	25.840	0,013	660	65	0,010	22.800	0,012	545	57

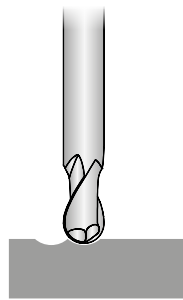

Schnitttiefe in einem Durchgang  
Depth of cut in one pass

Die Tabellenwerte sind Richtwerte. Es kann notwendig sein, die Werte den jeweiligen Bearbeitungsbedingungen anzupassen.

The recommended cutting data are only approximate values. It may be necessary to adjust them to each individual machining application.

Les valeurs du tableau sont indicatives. Il peut être nécessaire de les adapter aux conditions d'usage respectives.

Ausführung AFX / Design AFX / Modèle AFX

MATERIAL MATERIAL MATÉRIAU		Unlegierter Stahl / Non-alloyed steel / Acier non allié					Legierter Stahl / Alloy steel / Acier allié					Gehärteter Stahl / Hardened steel / Acier trempé				
Härte / Hardness / Dureté		~ HRc 35					HRc 35 ~ HRc 45					HRc 45 ~ HRc 55				
Zugfestigkeit / Strength / Résistance à la traction		~ 1100 N/mm <sup>2</sup>					1110 ~ 1500 N/mm <sup>2</sup>					1500 ~ 2000 N/mm <sup>2</sup>				
d	l <sub>z</sub>	a <sub>p</sub>	n	f <sub>z</sub>	v <sub>f</sub>	v <sub>c</sub>	a <sub>p</sub>	n	f <sub>z</sub>	v <sub>f</sub>	v <sub>c</sub>	a <sub>p</sub>	n	f <sub>z</sub>	v <sub>f</sub>	v <sub>c</sub>
(mm)	(mm)	(mm)	(U/min)	(mm)	(mm/min)	(m/min)	(mm)	(U/min)	(mm)	(mm/min)	(m/min)	(mm)	(U/min)	(mm)	(mm/min)	(m/min)
1,0	5,0	0,063	30.800	0,025	1540	97	0,049	29.100	0,023	1310	91	0,035	25.700	0,021	1075	81
1,0	6,0	0,036	27.720	0,022	1245	87	0,028	26.190	0,020	1060	82	0,020	23.130	0,019	870	73
1,0	8,0	0,036	27.720	0,022	1245	87	0,028	26.190	0,020	1060	82	0,020	23.130	0,019	870	73
2,0	8	0,126	18.000	0,050	1795	113	0,098	17.000	0,045	1525	107	0,070	15.000	0,043	1285	94
2,0	10	0,126	18.000	0,050	1795	113	0,098	17.000	0,045	1525	107	0,070	15.000	0,043	1285	94
3,0	8	0,270	13.700	0,075	2050	129	0,210	12.900	0,067	1730	122	0,150	11.400	0,063	1435	107
3,0	10	0,189	13.700	0,075	2050	129	0,147	12.900	0,067	1730	122	0,105	11.400	0,063	1435	107
3,0	12	0,189	13.700	0,075	2050	129	0,147	12.900	0,067	1730	122	0,105	11.400	0,063	1435	107
3,0	14	0,189	13.700	0,075	2050	129	0,147	12.900	0,067	1730	122	0,105	11.400	0,063	1435	107
3,0	16	0,108	12.330	0,067	1660	116	0,084	11.610	0,060	1400	109	0,060	10.260	0,057	1160	97
3,0	18	0,108	12.330	0,067	1660	116	0,084	11.610	0,060	1400	109	0,060	10.260	0,057	1160	97
3,0	20	0,108	12.330	0,067	1660	116	0,084	11.610	0,060	1400	109	0,060	10.260	0,057	1160	97
3,0	26	0,068	12.330	0,067	1660	116	0,053	11.610	0,060	1400	109	0,038	10.260	0,057	1160	97
3,0	30	0,068	12.330	0,067	1660	116	0,053	11.610	0,060	1400	109	0,038	10.260	0,057	1160	97
3,0	35	0,068	10.960	0,060	1310	103	0,053	10.320	0,054	1105	97	0,038	9.120	0,050	920	86
4,0	10	0,360	9.800	0,100	1965	123	0,280	9.300	0,090	1670	117	0,200	8.200	0,085	1395	103
4,0	12	0,360	9.800	0,100	1965	123	0,280	9.300	0,090	1670	117	0,200	8.200	0,085	1395	103
4,0	14	0,252	9.800	0,100	1965	123	0,196	9.300	0,090	1670	117	0,140	8.200	0,085	1395	103
4,0	16	0,252	9.800	0,100	1965	123	0,196	9.300	0,090	1670	117	0,140	8.200	0,085	1395	103
4,0	18	0,252	9.800	0,100	1965	123	0,196	9.300	0,090	1670	117	0,140	8.200	0,085	1395	103
4,0	20	0,252	9.800	0,100	1965	123	0,196	9.300	0,090	1670	117	0,140	8.200	0,085	1395	103
4,0	26	0,144	8.820	0,090	1590	111	0,122	8.370	0,081	1355	105	0,080	7.380	0,077	1130	93
4,0	30	0,144	8.820	0,090	1590	111	0,122	8.370	0,081	1355	105	0,080	7.380	0,077	1130	93
4,0	35	0,090	8.820	0,090	1590	111	0,070	8.370	0,081	1355	105	0,050	7.380	0,077	1130	93
4,0	40	0,090	8.820	0,090	1590	111	0,070	8.370	0,081	1355	105	0,050	7.380	0,077	1130	93
5,0	30	0,180	6.930	0,108	1495	109	0,140	6.570	0,090	1180	103	0,100	5.760	0,090	1040	90
6,0	20	0,378	6.500	0,146	1900	123	0,294	6.200	0,129	1600	117	0,210	5.500	0,121	1330	104
6,0	30	0,378	6.500	0,146	1900	123	0,294	6.200	0,129	1600	117	0,210	5.500	0,121	1330	104
8,0	25	0,504	4.850	0,186	1800	122	0,392	4.600	0,163	1500	116	0,280	4.000	0,160	1280	101
8,0	35	0,504	4.850	0,186	1800	122	0,392	4.600	0,163	1500	116	0,280	4.000	0,160	1280	101
10,0	30	0,900	3.850	0,214	1650	121	0,700	3.680	0,190	1400	116	0,500	3.200	0,188	1200	101
10,0	40	0,630	3.850	0,214	1650	121	0,490	3.680	0,190	1400	116	0,350	3.200	0,188	1200	101
12,0	32	1,080	3.200	0,238	1520	121	0,840	3.050	0,213	1300	115	0,600	2.650	0,208	1100	100

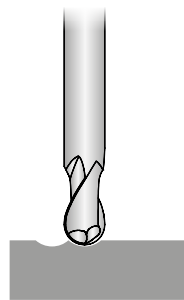

Schnitttiefe in einem Durchgang  
Depth of cut in one pass  
Profondeur de coupe dans un passage

Die Tabellenwerte sind Richtwerte. Es kann notwendig sein, die Werte den jeweiligen Bearbeitungsumständen anzupassen.

The recommended cutting data are only approximate values. It may be necessary to adjust them to each individual machining application.

Les valeurs du tableau sont indicatives. Il peut être nécessaire de les adapter aux conditions d'usage respectives.

Ausführung AFX / Design AFX / Modèle AFX

MATERIAL MATERIAL MATÉRIAU	Unlegierter Stahl / Non-alloyed steel				Legierter Stahl / Alloy steel / Acier allié				Gehärteter Stahl / Hardened steel / Acier trempé			
	Legierter Stahl / Alloy steel				Hochwarmfester Stahl / Heat resistant steel / Acier réfractaire							
	Gusseisen / Cast iron											
Härte / Hardness / Dureté Zugfestigkeit / Strength / Résistance à la traction	~ HRC 35 ~ 1100 N/mm <sup>2</sup>				HRC 35 ~ HRC 45 1110 ~ 1500 N/mm <sup>2</sup>				HRC 45 ~ HRC 55 1500 ~ 2000 N/mm <sup>2</sup>			
d (mm)	n (U/min)	f <sub>z</sub> (mm)	v <sub>f</sub> (mm/min)	v <sub>c</sub> (m/min)	n (U/min)	f <sub>z</sub> (mm)	v <sub>f</sub> (mm/min)	v <sub>c</sub> (m/min)	n (U/min)	f <sub>z</sub> (mm)	v <sub>f</sub> (mm/min)	v <sub>c</sub> (m/min)
1,0	26.800	0,002	250	84	16.080	0,002	150	51	10.720	0,001	47	34
1,2	22.500	0,003	265	85	13.500	0,003	160	51	9.000	0,001	47	34
1,5	18.750	0,004	270	88	11.250	0,004	165	53	7.500	0,002	47	35
2,0	14.450	0,005	295	91	9.450	0,005	180	59	6.300	0,002	53	40
2,5	12.800	0,006	315	101	8.200	0,006	195	64	5.250	0,003	58	41
3,0	11.150	0,008	335	105	6.950	0,008	210	66	4.200	0,004	63	40
3,5	10.300	0,011	465	113	6.360	0,011	290	70	3.940	0,004	63	43
4,0	9.450	0,016	600	119	5.780	0,016	370	73	3.680	0,004	63	46
4,5	8.660	0,018	615	122	5.250	0,018	375	74	3.290	0,005	70	47
5,0	7.880	0,020	630	124	4.730	0,020	380	74	2.900	0,006	75	46
5,5	7.410	0,022	660	128	4.460	0,023	405	77	2.700	0,007	80	47
6,0	6.950	0,025	695	131	4.200	0,026	430	79	2.500	0,009	85	47
6,5	6.530	0,027	710	133	3.940	0,027	425	80	2.400	0,010	95	49
7,0	6.100	0,030	720	134	3.680	0,028	415	81	2.300	0,011	100	51
7,5	5.680	0,032	735	134	3.410	0,030	410	80	2.200	0,013	110	52
8,0	5.250	0,035	745	132	3.150	0,032	400	79	2.100	0,014	115	53
8,5	4.960	0,036	720	132	2.990	0,032	380	80	2.000	0,014	110	53
9,0	4.660	0,037	695	132	2.830	0,031	355	80	1.900	0,014	105	54
9,5	4.370	0,038	665	130	2.660	0,031	335	79	1.800	0,014	100	54
10,0	4.080	0,039	640	128	2.500	0,032	315	79	1.700	0,014	95	53
10,5	3.910	0,040	620	129	2.400	0,032	305	79	1.640	0,014	95	54
11,0	3.750	0,040	595	130	2.300	0,032	290	79	1.580	0,014	90	55
11,5	3.590	0,040	570	130	2.200	0,032	280	79	1.510	0,015	90	50
12,0	3.430	0,040	545	129	2.100	0,032	265	79	1.450	0,015	85	55
13,0	3.260	0,040	520	133	2.000	0,031	250	82	1.370	0,015	80	56
14,0	3.090	0,040	490	136	1.900	0,031	235	84	1.290	0,015	75	57
16,0	2.750	0,040	440	138	1.700	0,032	215	85	1.130	0,014	65	57
18,0	2.430	0,040	385	137	1.510	0,031	190	85	990	0,014	55	56
20,0	2.100	0,040	335	132	1.330	0,032	170	84	850	0,012	42	53
25,0	1.700	0,039	265	134	1.050	0,032	135	82	680	0,012	32	53

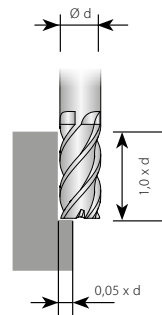

Die Tabellenwerte sind Richtwerte. Es kann notwendig sein, die Werte den jeweiligen Bearbeitungsumständen anzupassen.

The recommended cutting data are only approximate values. It may be necessary to adjust them to each individual machining application.

Les valeurs du tableau sont indicatives. Il peut être nécessaire de les adapter aux conditions d'usage respectives.

Ausführung AFX / Design AFX / Modèle AFX

MATERIAL MATERIAL MATÉRIAU		Unlegierter Stahl / Non-alloyed steel / Acier non allié					Legierter Stahl / Alloy steel / Acier allié					Gehärteter Stahl / Hardened steel / Acier trempé				
Härte / Hardness / Dureté		~ HRc 35					HRc 35 ~ HRc 45					HRc 45 ~ HRc 55				
Zugfestigkeit / Strength / Résistance à la traction		~ 1100 N/mm <sup>2</sup>					1110 ~ 1500 N/mm <sup>2</sup>					1500 ~ 2000 N/mm <sup>2</sup>				
d	l <sub>2</sub>	a <sub>e</sub>	n	f <sub>z</sub>	v <sub>f</sub>	v <sub>c</sub>	a <sub>e</sub>	n	f <sub>z</sub>	v <sub>f</sub>	v <sub>c</sub>	a <sub>e</sub>	n	f <sub>z</sub>	v <sub>f</sub>	v <sub>c</sub>
(mm)	(mm)	(mm)	(U/min)	(mm)	(mm/min)	(m/min)	(mm)	(U/min)	(mm)	(mm/min)	(m/min)	(mm)	(U/min)	(mm)	(mm/min)	(m/min)
1,0	4	0,021	33.100	0,003	360	104	0,016	21.600	0,003	260	68	0,013	13.200	0,003	140	41
1,0	6	0,012	29.790	0,002	290	94	0,009	19.440	0,003	210	61	0,007	11.880	0,002	115	37
1,0	8	0,012	29.790	0,002	290	94	0,009	19.440	0,003	210	61	0,007	11.880	0,002	115	37
1,2	4	0,025	29.750	0,003	365	112	0,019	18.900	0,004	265	71	0,015	11.700	0,003	140	44
1,2	6	0,025	29.750	0,003	365	112	0,019	18.900	0,004	265	71	0,015	11.700	0,003	140	44
1,2	8	0,014	26.780	0,003	295	101	0,011	17.010	0,003	215	64	0,009	10.530	0,003	115	40
1,5	6	0,032	26.400	0,004	370	124	0,024	16.200	0,004	270	76	0,019	10.200	0,003	140	48
1,5	8	0,018	23.760	0,003	300	112	0,014	14.580	0,004	220	69	0,011	9.180	0,003	115	43
1,5	10	0,018	23.760	0,003	300	112	0,014	14.580	0,004	220	69	0,011	9.180	0,003	115	43
1,5	12	0,018	23.760	0,003	300	112	0,014	14.580	0,004	220	69	0,011	9.180	0,003	115	43
2,0	6	0,060	21.600	0,004	380	136	0,045	13.800	0,005	280	87	0,036	8.640	0,004	150	54
2,0	8	0,042	21.600	0,004	380	136	0,032	13.800	0,005	280	87	0,025	8.640	0,004	150	54
2,0	10	0,042	21.600	0,004	380	136	0,032	13.800	0,005	280	87	0,025	8.640	0,004	150	54
2,0	12	0,024	19.440	0,004	310	122	0,018	12.420	0,005	225	78	0,014	7.780	0,004	120	49
3,0	8	0,090	15.900	0,006	400	150	0,068	10.300	0,008	310	97	0,054	6.300	0,006	150	59
3,0	10	0,063	15.900	0,006	400	150	0,047	10.300	0,008	310	97	0,038	6.300	0,006	150	59
3,0	12	0,063	15.900	0,006	400	150	0,047	10.300	0,008	310	97	0,038	6.300	0,006	150	59
3,0	16	0,036	14.310	0,006	325	135	0,027	9.270	0,007	250	87	0,022	5.670	0,005	120	53
3,0	20	0,036	14.310	0,006	325	135	0,027	9.270	0,007	250	87	0,022	5.670	0,005	120	53
3,0	26	0,023	14.310	0,006	325	135	0,017	9.270	0,007	250	87	0,014	5.670	0,005	120	53
4,0	10	0,120	12.800	0,010	500	161	0,090	8.200	0,011	360	103	0,072	5.150	0,008	160	65
4,0	12	0,120	12.800	0,010	500	161	0,090	8.200	0,011	360	103	0,072	5.150	0,008	160	65
4,0	16	0,084	12.800	0,010	500	161	0,063	8.200	0,011	360	103	0,050	5.150	0,008	160	65
4,0	20	0,084	12.800	0,010	500	161	0,063	8.200	0,011	360	103	0,050	5.150	0,008	160	65
4,0	26	0,048	11.520	0,009	405	145	0,036	7.380	0,010	290	93	0,029	4.640	0,007	130	58
6,0	20	0,126	9.500	0,013	510	179	0,095	6.000	0,018	430	113	0,076	3.930	0,013	200	74
8,0	25	0,168	7.200	0,019	550	181	0,126	4.550	0,024	430	114	0,101	3.020	0,017	200	76
8,0	35	0,168	7.200	0,019	550	181	0,126	4.550	0,024	430	114	0,101	3.020	0,017	200	76
10,0	30	0,300	6.000	0,023	550	188	0,225	4.000	0,027	430	126	0,180	2.420	0,021	200	76
10,0	40	0,210	6.000	0,023	550	188	0,158	4.000	0,027	430	126	0,126	2.420	0,021	200	76
12,0	32	0,360	5.000	0,022	430	188	0,270	3.340	0,028	380	126	0,216	2.000	0,020	160	75
12,0	45	0,252	5.000	0,022	430	188	0,189	3.340	0,028	380	126	0,151	2.000	0,020	160	75
16,0	35	0,480	3.720	0,022	330	187	0,360	2.520	0,028	280	127	0,288	1.540	0,022	135	77
20,0	40	0,600	3.000	0,023	270	188	0,450	1.950	0,027	210	123	0,360	1.200	0,021	100	75

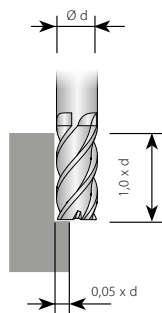

Die Tabellenwerte sind Richtwerte. Es kann notwendig sein, die Werte den jeweiligen Bearbeitungsumständen anzupassen.

The recommended cutting data are only approximate values. It may be necessary to adjust them to each individual machining application.

Les valeurs du tableau sont indicatives. Il peut être nécessaire de les adapter aux conditions d'usage respectives.



Ausführung AFX / Design AFX / Modèle AFX

MATERIAL MATERIAL MATÉRIAU	Unlegierter Stahl / Non-alloyed steel Legierter Stahl / Alloy steel Gusseisen / Cast iron				Legierter Stahl / Alloy steel / Acier allié Hochwarmfester Stahl / Heat resistant steel / Acier réfractaire				Gehärteter Stahl / Hardened steel / Acier trempé				
	~ HRc 35 ~ 1100 N/mm <sup>2</sup>				HRc 35 ~ HRc 45 1110 ~ 1500 N/mm <sup>2</sup>				HRc 45 ~ HRc 55 1500 ~ 2000 N/mm <sup>2</sup>				
Härte / Hardness / Dureté Zugfestigkeit / Strength / Résistance à la traction	d (mm)	n (U/min)	f <sub>z</sub> (mm)	v <sub>f</sub> (mm/min)	v <sub>c</sub> (m/min)	n (U/min)	f <sub>z</sub> (mm)	v <sub>f</sub> (mm/min)	v <sub>c</sub> (m/min)	n (U/min)	f <sub>z</sub> (mm)	v <sub>f</sub> (mm/min)	v <sub>c</sub> (m/min)
1,0	27.600	0,003	300	87	18.000	0,003	220	57	11.000	0,003	120	35	
1,5	22.000	0,004	310	104	13.500	0,004	230	64	8.500	0,004	120	40	
2,0	18.000	0,004	320	113	11.560	0,005	240	73	7.200	0,005	130	45	
2,5	15.000	0,006	330	118	9.500	0,007	250	75	6.100	0,005	130	48	
3,0	13.240	0,006	340	125	8.560	0,008	260	81	5.280	0,006	130	50	
4,0	10.720	0,010	420	135	6.820	0,011	300	86	4.300	0,008	140	54	
5,0	9.160	0,012	430	144	5.800	0,016	360	91	3.800	0,011	170	60	
6,0	7.900	0,014	430	149	5.040	0,018	360	95	3.280	0,013	170	62	
8,0	6.000	0,019	460	151	3.800	0,024	360	96	2.520	0,017	170	63	
10,0	5.040	0,023	460	158	3.280	0,027	360	103	2.020	0,021	170	63	
12,0	4.120	0,022	360	155	2.780	0,029	320	105	1.680	0,021	140	63	
16,0	3.100	0,023	280	156	2.100	0,027	230	106	1.280	0,022	115	64	
20,0	2.520	0,023	230	158	1.640	0,027	180	103	1.000	0,023	90	63	

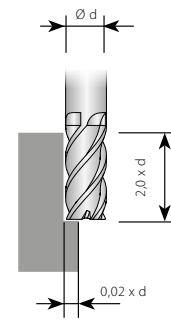
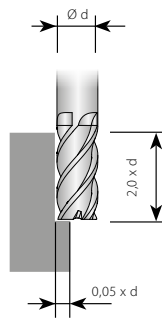

Die Tabellenwerte sind Richtwerte. Es kann notwendig sein, die Werte den jeweiligen Bearbeitungsumständen anzupassen.

The recommended cutting data are only approximate values. It may be necessary to adjust them to each individual machining application.

Les valeurs du tableau sont indicatives. Il peut être nécessaire de les adapter aux conditions d'usinage respectives.

Ausführung AFX / Design AFX / Modèle AFX

MATERIAL MATERIAL MATÉRIAU	Unlegierter Stahl / Non-alloyed steel				Legierter Stahl / Alloy steel				Gehärteter Stahl / Hardened steel / Acier trempé			
	Legierter Stahl / Alloy steel Gusseisen / Cast iron				Hochwarmfester Stahl / Heat resistant steel							
	~ HRC 35 ~ 1100 N/mm <sup>2</sup>				HRC 35 ~ HRC 45 1110 ~ 1500 N/mm <sup>2</sup>				HRC 45 ~ HRC 55 1500 ~ 2000 N/mm <sup>2</sup>			
Härte / Hardness / Dureté Zugfestigkeit / Strength / Résistance à la traction	n	f <sub>z</sub>	v <sub>f</sub>	v <sub>c</sub>	n	f <sub>z</sub>	v <sub>f</sub>	v <sub>c</sub>	n	f <sub>z</sub>	v <sub>f</sub>	v <sub>c</sub>
d (mm)	(U/min)	(mm)	(mm/min)	(m/min)	(U/min)	(mm)	(mm/min)	(m/min)	(U/min)	(mm)	(mm/min)	(m/min)
1,0	26.800	0,002	250	84	16.080	0,002	150	51	10.720	0,001	47	34
1,2	22.500	0,003	265	85	13.500	0,003	160	51	9.000	0,001	47	34
1,5	18.750	0,004	270	88	11.250	0,004	165	53	7.500	0,002	47	35
2,0	14.450	0,005	295	91	9.450	0,005	180	59	6.300	0,002	53	40
2,5	12.800	0,006	315	101	8.200	0,006	195	64	5.250	0,003	58	41
3,0	11.150	0,008	335	105	6.950	0,008	210	66	4.200	0,004	63	40
3,5	10.300	0,011	465	113	6.360	0,011	290	70	3.940	0,004	63	43
4,0	9.450	0,016	600	119	5.780	0,016	370	73	3.680	0,004	63	46
4,5	8.660	0,018	615	122	5.250	0,018	375	74	3.290	0,005	70	47
5,0	7.880	0,020	630	124	4.730	0,020	380	74	2.900	0,006	75	46
5,5	7.410	0,022	660	128	4.460	0,023	405	77	2.700	0,007	80	47
6,0	6.950	0,025	695	131	4.200	0,026	430	79	2.500	0,009	85	47
6,5	6.530	0,027	710	133	3.940	0,027	425	80	2.400	0,010	95	49
7,0	6.100	0,030	720	134	3.680	0,028	415	81	2.300	0,011	100	51
7,5	5.680	0,032	735	134	3.410	0,030	410	80	2.200	0,013	110	52
8,0	5.250	0,035	745	132	3.150	0,032	400	79	2.100	0,014	115	53
8,5	4.960	0,036	720	132	2.990	0,032	380	80	2.000	0,014	110	53
9,0	4.660	0,037	695	132	2.830	0,031	355	80	1.900	0,014	105	54
9,5	4.370	0,038	665	130	2.660	0,031	335	79	1.800	0,014	100	54
10,0	4.080	0,039	640	128	2.500	0,032	315	79	1.700	0,014	95	53
10,5	3.910	0,040	620	129	2.400	0,032	305	79	1.640	0,014	95	54
11,0	3.750	0,040	595	130	2.300	0,032	290	79	1.580	0,014	90	55
11,5	3.590	0,040	570	130	2.200	0,032	280	79	1.510	0,015	90	50
12,0	3.430	0,040	545	129	2.100	0,032	265	79	1.450	0,015	85	55
13,0	3.260	0,040	520	133	2.000	0,031	250	82	1.370	0,015	80	56
14,0	3.090	0,040	490	136	1.900	0,031	235	84	1.290	0,015	75	57
16,0	2.750	0,040	440	138	1.700	0,032	215	85	1.130	0,014	65	57
18,0	2.430	0,040	385	137	1.510	0,031	190	85	990	0,014	55	56
20,0	2.100	0,040	335	132	1.330	0,032	170	84	850	0,012	42	53
25,0	1.700	0,039	265	134	1.050	0,032	135	82	680	0,012	32	53

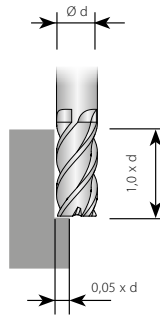

Die Tabellenwerte sind Richtwerte. Es kann notwendig sein, die Werte den jeweiligen Bearbeitungsumständen anzupassen.

The recommended cutting data are only approximate values. It may be necessary to adjust them to each individual machining application.

Les valeurs du tableau sont indicatives. Il peut être nécessaire de les adapter aux conditions d'usage respectives.

### Ausführung AFX / Design AFX / Modèle AFX

MATERIAL MATERIAL MATÉRIAU		Unlegierter Stahl / Non-alloyed steel / Acier non allié				Legierter Stahl / Alloy steel / Acier allié				Gehärteter Stahl / Hardened steel / Acier trempé			
		Legierter Stahl / Alloy steel / Acier allié				Hochwarmfester Stahl / Heat resistant steel / Acier réfractaire							
Härte / Hardness / Dureté		~ HRC 35				HRc 35 ~ HRc 45				HRc 45 ~ HRc 55			
Zugfestigkeit / Strength / Résistance à la traction		~ 1100 N/mm²				1110 ~ 1500 N/mm²				1500 ~ 2000 N/mm²			
d	l <sub>1</sub>	n	f <sub>z</sub>	v <sub>f</sub>	v <sub>c</sub>	n	f <sub>z</sub>	v <sub>f</sub>	v <sub>c</sub>	n	f <sub>z</sub>	v <sub>f</sub>	v <sub>c</sub>
(mm)	(mm)	(U/min)	(mm)	(mm/min)	(m/min)	(U/min)	(mm)	(mm/min)	(m/min)	(U/min)	(mm)	(mm/min)	(m/min)
1,0	3	19.200	0,002	180	60	10.940	0,002	70	34	6.720	0,001	35	21
1,0	4	19.200	0,002	180	60	10.940	0,002	70	34	6.720	0,001	35	21
1,0	5	19.200	0,002	180	60	10.940	0,002	70	34	6.720	0,001	35	21
1,0	6	17.280	0,002	145	54	9.850	0,002	60	31	6.050	0,001	30	19
1,5	6	13.800	0,004	215	65	7.870	0,003	85	37	4.830	0,002	45	23
2,0	8	10.580	0,006	240	66	6.050	0,004	95	38	3.780	0,004	55	24
2,0	10	10.580	0,006	240	66	6.050	0,004	95	38	3.780	0,004	55	24
2,0	12	9.530	0,005	195	60	5.440	0,004	80	34	3.400	0,003	45	21
2,0	14	9.530	0,005	195	60	5.440	0,004	80	34	3.400	0,003	45	21
2,5	10	8.990	0,007	260	71	5.170	0,005	110	41	3.210	0,005	60	25
2,5	12	8.990	0,007	260	71	5.170	0,005	110	41	3.210	0,005	60	25
3,0	10	7.400	0,009	275	70	4.280	0,007	120	40	2.640	0,006	65	25
3,0	12	7.400	0,009	275	70	4.280	0,007	120	40	2.640	0,006	65	25
3,0	16	6.660	0,009	250	63	3.860	0,007	110	36	2.380	0,006	60	22
3,0	20	6.660	0,008	225	63	3.860	0,006	95	36	2.380	0,006	55	22
3,0	26	6.660	0,008	200	63	3.860	0,006	85	36	2.380	0,005	50	22
3,0	30	6.660	0,008	200	63	3.860	0,006	85	36	2.380	0,005	50	22
4,0	12	6.000	0,014	335	75	3.410	0,010	140	43	2.150	0,008	70	27
4,0	16	6.000	0,014	335	75	3.410	0,010	140	43	2.150	0,008	70	27
4,0	20	6.000	0,014	335	75	3.410	0,010	140	43	2.150	0,008	70	27
4,0	26	5.400	0,013	270	68	3.070	0,009	110	39	1.930	0,008	60	24
4,0	30	5.400	0,013	270	68	3.070	0,009	110	39	1.930	0,008	60	24
5,0	20	5.120	0,021	430	80	2.900	0,015	170	46	1.900	0,011	85	30
5,0	25	5.120	0,021	430	80	2.900	0,015	170	46	1.900	0,011	85	30
5,0	30	4.610	0,019	350	72	2.610	0,013	135	41	1.710	0,010	70	27
6,0	15	4.420	0,029	515	83	2.520	0,021	215	48	1.640	0,017	110	31
6,0	20	4.420	0,029	515	83	2.520	0,021	215	48	1.640	0,017	110	31
6,0	25	4.420	0,029	515	83	2.520	0,021	215	48	1.640	0,017	110	31
6,0	30	4.420	0,025	440	83	2.520	0,018	185	48	1.640	0,014	90	31
6,0	35	3.970	0,025	395	75	2.270	0,018	165	43	1.480	0,014	85	28
6,0	40	3.970	0,022	350	75	2.270	0,016	145	43	1.480	0,013	75	28
6,0	45	3.970	0,022	350	75	2.270	0,016	145	43	1.480	0,013	75	28
8,0	25	3.360	0,041	550	84	1.900	0,028	215	48	1.260	0,022	110	32
8,0	30	3.360	0,041	550	84	1.900	0,028	215	48	1.260	0,022	110	32
8,0	35	3.360	0,041	550	84	1.900	0,028	215	48	1.260	0,022	110	32
8,0	40	3.360	0,035	470	84	1.900	0,024	185	48	1.260	0,018	90	32
8,0	45	3.020	0,035	420	76	1.710	0,024	165	43	1.130	0,019	85	28
8,0	50	3.020	0,031	375	76	1.710	0,021	145	43	1.130	0,017	75	28
10,0	30	2.820	0,049	550	59	1.640	0,033	215	52	1.010	0,027	110	32
10,0	35	2.820	0,049	550	59	1.640	0,033	215	52	1.010	0,027	110	32
10,0	40	2.820	0,049	550	59	1.640	0,033	215	52	1.010	0,027	110	32
10,0	45	2.820	0,042	470	89	1.640	0,028	185	52	1.010	0,022	90	32
10,0	50	2.820	0,042	470	89	1.640	0,028	185	52	1.010	0,022	90	32
12,0	35	2.300	0,047	430	87	1.390	0,034	190	52	840	0,025	85	32
12,0	40	2.300	0,047	430	87	1.390	0,034	190	52	840	0,025	85	32
12,0	45	2.300	0,040	365	87	1.390	0,030	165	52	840	0,021	70	32
12,0	50	2.300	0,040	365	87	1.390	0,030	165	52	840	0,021	70	32
12,0	55	2.300	0,040	365	87	1.390	0,030	165	52	840	0,021	70	32
12,0	60	2.300	0,035	325	87	1.390	0,026	145	52	840	0,019	65	32
14,0	50	2.120	0,041	345	93	1.230	0,029	145	54	760	0,021	68	33
16,0	50	1.940	0,050	385	98	1.070	0,035	150	54	670	0,026	70	34
16,0	60	1.940	0,042	325	98	1.070	0,030	130	54	670	0,022	60	34
16,0	70	1.940	0,042	325	98	1.070	0,030	130	54	670	0,022	60	34
18,0	50	1.680	0,049	330	95	940	0,035	130	53	590	0,028	65	33
20,0	60	1.420	0,048	275	89	820	0,034	110	52	500	0,028	55	31
20,0	90	1.420	0,036	205	89	820	0,024	80	52	500	0,020	40	31
25,0	90	1.100	0,042	185	86	820	0,027	90	64	500	0,023	45	39

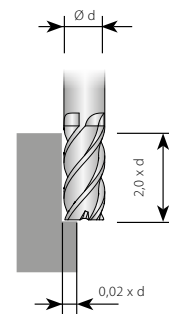
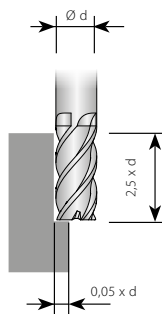

Die Tabellenwerte sind Richtwerte. Es kann notwendig sein, die Werte den jeweiligen Bearbeitungsumständen anzupassen.

The recommended cutting data are only approximate values. It may be necessary to adjust them to each individual machining application.

Les valeurs du tableau sont indicatives. Il peut être nécessaire de les adapter aux conditions d'usinage respectives.

AFX

Ausführung AFX / Design AFX / Modèle AFX

MATERIAL MATERIAL MATÉRIAU		Unlegierter Stahl / Non-alloyed steel / Acier non allié					Legierter Stahl / Alloy steel / Acier allié					Gehärteter Stahl / Hardened steel / Acier trempé				
Härte / Hardness / Dureté		~ HRc 35					HRc 35 ~ HRc 45					HRc 45 ~ HRc 55				
Zugfestigkeit / Strength / Résistance à la traction		~ 1100 N/mm <sup>2</sup>					1110 ~ 1500 N/mm <sup>2</sup>					1500 ~ 2000 N/mm <sup>2</sup>				
d (mm)	l <sub>z</sub> (mm)	a <sub>e</sub> (mm)	n (U/min)	f <sub>z</sub> (mm)	v <sub>f</sub> (mm/min)	v <sub>c</sub> (m/min)	a <sub>e</sub> (mm)	n (U/min)	f <sub>z</sub> (mm)	v <sub>f</sub> (mm/min)	v <sub>c</sub> (m/min)	a <sub>e</sub> (mm)	n (U/min)	f <sub>z</sub> (mm)	v <sub>f</sub> (mm/min)	v <sub>c</sub> (m/min)
1,0	4	0,015	22.000	0,004	310	69	0,011	13.500	0,003	180	42	0,009	8.500	0,001	50	27
1,0	5	0,015	22.000	0,004	310	69	0,011	13.500	0,003	180	42	0,009	8.500	0,001	50	27
1,0	6	0,008	19.800	0,003	250	62	0,006	12.150	0,003	145	38	0,005	7.650	0,001	40	24
1,0	8	0,008	19.800	0,003	250	62	0,006	12.150	0,003	145	38	0,005	7.650	0,001	40	24
1,5	6	0,022	17.000	0,005	320	80	0,017	10.700	0,004	190	50	0,013	6.500	0,002	50	31
1,5	8	0,013	15.300	0,004	260	72	0,009	9.630	0,004	155	45	0,008	5.850	0,002	40	28
1,5	10	0,013	15.300	0,004	260	72	0,009	9.630	0,004	155	45	0,008	5.850	0,002	40	28
1,5	12	0,013	15.300	0,004	260	72	0,009	9.630	0,004	155	45	0,008	5.850	0,002	40	28
1,5	16	0,008	13.600	0,004	205	64	0,006	8.560	0,004	120	40	0,005	5.200	0,001	30	25
2,0	8	0,029	13.900	0,006	330	87	0,022	9.070	0,006	200	57	0,018	6.000	0,003	60	38
2,0	10	0,029	13.900	0,006	330	87	0,022	9.070	0,006	200	57	0,018	6.000	0,003	60	38
2,0	12	0,017	12.510	0,005	265	79	0,013	8.160	0,005	160	51	0,010	5.400	0,002	50	34
2,0	16	0,017	12.510	0,005	265	79	0,013	8.160	0,005	160	51	0,010	5.400	0,002	50	34
3,0	10	0,044	10.700	0,009	380	101	0,033	6.670	0,009	240	63	0,026	4.030	0,004	70	38
3,0	12	0,044	10.700	0,009	380	101	0,033	6.670	0,009	240	63	0,026	4.030	0,004	70	38
3,0	16	0,025	9.630	0,008	310	91	0,019	6.000	0,008	195	57	0,015	3.630	0,004	55	34
3,0	20	0,025	9.630	0,008	310	91	0,019	6.000	0,008	195	57	0,015	3.630	0,004	55	34
3,0	30	0,016	9.630	0,008	310	91	0,012	6.000	0,008	198	57	0,009	3.630	0,004	55	34
4,0	12	0,084	9.070	0,019	680	114	0,063	5.540	0,019	420	70	0,050	3.530	0,005	70	44
4,0	16	0,059	9.070	0,019	680	114	0,044	5.540	0,019	420	70	0,035	3.530	0,005	70	44
4,0	20	0,059	9.070	0,019	680	114	0,044	5.540	0,019	420	70	0,035	3.530	0,005	70	44
4,0	30	0,034	8.160	0,017	550	103	0,025	4.990	0,017	340	63	0,020	3.180	0,004	55	40
4,0	40	0,021	8.160	0,017	550	103	0,016	4.990	0,017	340	63	0,013	3.180	0,004	55	40
5,0	20	0,074	7.560	0,024	720	119	0,055	5.430	0,024	430	71	0,044	2.780	0,008	85	44
5,0	40	0,042	6.800	0,022	585	107	0,032	4.080	0,021	350	64	0,025	2.500	0,007	70	39
6,0	15	0,126	6.670	0,030	790	126	0,095	4.030	0,030	490	76	0,076	2.400	0,010	95	45
6,0	30	0,088	6.670	0,030	790	126	0,066	4.030	0,030	490	76	0,053	2.400	0,010	95	45
8,0	25	0,118	5.040	0,042	850	127	0,088	3.020	0,037	450	76	0,071	2.010	0,016	130	51
8,0	42	0,067	4.540	0,038	690	114	0,050	2.720	0,034	365	68	0,040	1.810	0,015	105	45
10,0	30	0,210	3.910	0,047	730	123	0,158	2.400	0,038	360	75	0,126	1.630	0,016	105	51
10,0	45	0,147	3.910	0,047	730	123	0,110	2.400	0,038	360	75	0,088	1.630	0,016	105	51
12,0	35	0,252	3.300	0,047	620	124	0,189	2.010	0,037	300	76	0,151	1.400	0,017	95	53
12,0	50	0,176	3.300	0,047	620	124	0,132	2.010	0,037	300	76	0,106	1.400	0,017	95	53

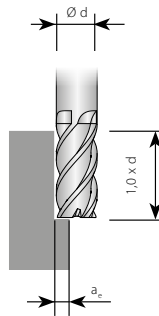

Die Tabellenwerte sind Richtwerte. Es kann notwendig sein, die Werte den jeweiligen Bearbeitungsumständen anzupassen.

The recommended cutting data are only approximate values. It may be necessary to adjust them to each individual machining application.

Les valeurs du tableau sont indicatives. Il peut être nécessaire de les adapter aux conditions d'usage respectives.

Ausführung AFX / Design AFX / Modèle AFX

Normale Geschwindigkeit / Normal speed / Vitesse normale

MATERIAL MATERIAL MATÉRIAU		Unlegierter Stahl / Non-alloyed steel Legierter Stahl / Alloy steel Gusseisen / Cast iron				Legierter Stahl / Alloy steel / Acier allié Hochwärmfester Stahl / Heat resistant steel / Acier réfractaire				Gehärteter Stahl / Hardened steel / Acier trempé			
Härte / Hardness / Dureté Zugfestigkeit / Strength / Résistance à la traction		~ HRC 35 ~ 1100 N/mm <sup>2</sup>				HRC 35 ~ HRC 45 1110 ~ 1500 N/mm <sup>2</sup>				HRC 45 ~ HRC 55 1500 ~ 2000 N/mm <sup>2</sup>			
d <sub>1</sub> (mm)	l <sub>1</sub> (mm)	n (U/min)	f <sub>z</sub> (mm)	v <sub>f</sub> (mm/min)	v <sub>c</sub> (m/min)	n (U/min)	f <sub>z</sub> (mm)	v <sub>f</sub> (mm/min)	v <sub>c</sub> (m/min)	n (U/min)	f <sub>z</sub> (mm)	v <sub>f</sub> (mm/min)	v <sub>c</sub> (m/min)
6,0	15	5.840	0,060	2.100	110	4.075	0,059	1.440	77	1.660	0,022	220	31
6,0	30	5.840	0,051	1.785	110	4.075	0,050	1.225	77	1.660	0,019	190	31
8,0	20	4.410	0,079	2.100	111	3.085	0,078	1.440	78	1.220	0,030	220	31
8,0	40	4.410	0,067	1.785	111	3.085	0,066	1.225	78	1.220	0,026	190	31
10,0	25	3.530	0,099	2.100	111	2.435	0,099	1.440	76	1.050	0,035	220	33
10,0	40	3.530	0,099	2.100	111	2.435	0,099	1.440	76	1.050	0,035	220	33
12,0	30	2.980	0,099	1.765	112	2.100	0,097	1.220	79	880	0,036	190	33
12,0	50	2.980	0,084	1.500	112	2.100	0,082	1.035	79	880	0,031	165	33
12,0	60	2.980	0,074	1.325	112	2.100	0,073	915	79	880	0,027	140	33
16,0	40	2.205	0,100	1.325	111	1.555	0,099	925	78	670	0,034	135	34
16,0	60	2.205	0,085	1.125	111	1.555	0,085	790	78	670	0,029	115	34
20,0	45	1.765	0,100	1.060	111	1.220	0,099	725	77	525	0,037	115	33
20,0	60	1.765	0,100	1.060	111	1.220	0,099	725	77	525	0,037	115	33

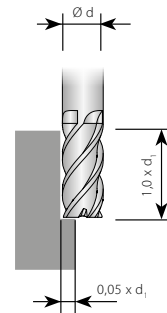
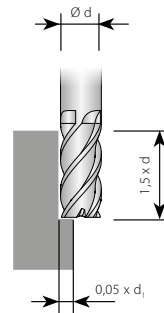
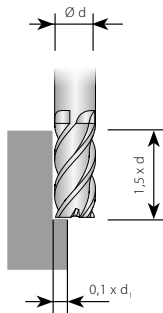

Hochgeschwindigkeitsfräsen HFC / High speed / Fraisage à grande vitesse

MATERIAL MATERIAL MATÉRIAU		Legierter Stahl / Alloy steel / Acier allié Hochwärmfester Stahl / Heat resistant steel / Acier réfractaire				Gehärteter Stahl / Hardened steel / Acier trempé			
Härte / Hardness / Dureté Zugfestigkeit / Strength / Résistance à la traction		HRC 35 ~ HRC 45 1110 ~ 1500 N/mm <sup>2</sup>				HRC 45 ~ HRC 55 1500 ~ 2000 N/mm <sup>2</sup>			
d <sub>1</sub> (mm)	l <sub>1</sub> (mm)	n (U/min)	f <sub>z</sub> (mm)	v <sub>f</sub> (mm/min)	v <sub>c</sub> (m/min)	n (U/min)	f <sub>z</sub> (mm)	v <sub>f</sub> (mm/min)	v <sub>c</sub> (m/min)
6,0	15	17.640	0,060	6.395	333	8.820	0,061	3.205	166
6,0	30	17.640	0,051	5.435	333	8.820	0,051	2.720	166
8,0	20	13.230	0,081	6.395	333	6.615	0,081	3.205	166
8,0	40	13.230	0,068	5.435	333	6.615	0,069	2.725	166
10,0	25	10.480	0,100	6.290	329	5.290	0,101	3.205	166
10,0	40	10.480	0,100	6.290	329	5.290	0,101	3.205	166
12,0	30	8.820	0,100	5.290	333	4.410	0,100	2.645	166
12,0	50	8.820	0,085	4.500	333	4.410	0,085	2.245	166
12,0	60	8.820	0,075	3.970	333	4.410	0,075	1.985	166
16,0	40	6.615	0,100	3.970	333	3.320	0,100	1.985	167
16,0	60	6.615	0,085	3.375	333	3.320	0,085	1.685	137
20,0	45	5.290	0,101	3.205	332	2.645	0,097	1.545	166
20,0	60	5.290	0,101	3.205	332	2.645	0,097	1.545	166

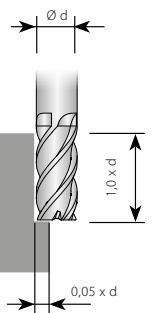
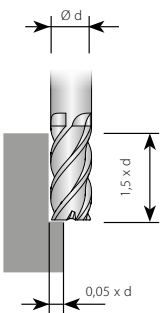

Die Tabellenwerte sind Richtwerte. Es kann notwendig sein, die Werte den jeweiligen Bearbeitungsumständen anzupassen.

The recommended cutting data are only approximate values. It may be necessary to adjust them to each individual machining application.

Les valeurs du tableau sont indicatives. Il peut être nécessaire de les adapter aux conditions d'usage respectives.

AFX

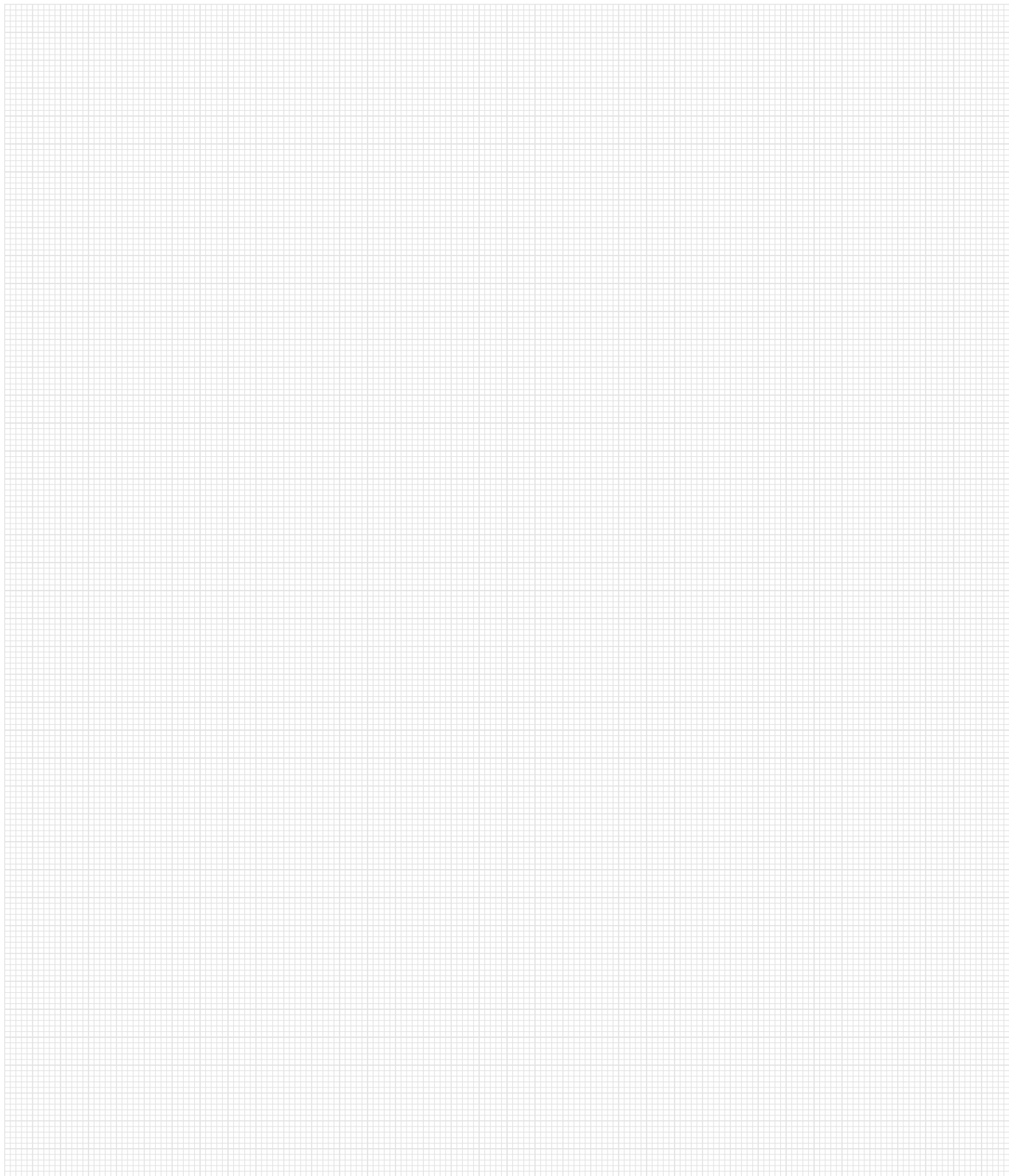

**Weitere Informationen finden Sie unter**  
*For more information see*  
**Pour plus d'informations**

**[www.arno.de](http://www.arno.de)**

# ARNO<sup>®</sup>

## WERKZEUGE

We have a passion for precision.

## PM-HSS-FRÄSER

*PM and HSS milling cutters / Fraises PM-HSS*

### Ausführung

FP – für Stahl, rostfreien Stahl und Gusswerkstoffe

### *Design*

*FP – for steel, stainless steel and cast materials*

### Modèle

FP – pour matériaux en acier, en acier inoxydable et en fonte



# Übersicht pulvermetallurgische HSS-Fräser

Overview powder metal HSS millings

Aperçu des fraises HSS formées par métallurgie des poudres

Bezeichnung Description Désignation	Schneiden Flutes Tranchants	Fräser Type Type de fraise	Ausführung Design Modèle	Spiralwinkel Helix angle Angle d'hélice	Abb. Picture Fig.	Seite Page Page
<b>FP - Universalfräser für Stahl, rostfreien Stahl, Gusswerkstoffe / Universal cutter for steel, stainless steel and cast materials</b>						
FP60120-...	2	<b>PM-HSS Schaftfräser</b> <i>PM-HSS end-mill</i> Fraise à queue PM-HSS	<b>kurz</b> <i>short</i> courte	30°		<b>332</b>
FP60121-...	2	<b>PM-HSS Schaftfräser</b> <i>PM-HSS end mill</i> Fraise à queue PM-HSS	<b>lang</b> <i>long</i> longue	30°		<b>333</b>
FP60320-...	2	<b>PM-HSS-Radiusfräser</b> <i>PM-HSS ball-nose end-mill</i> Fraise hémisphérique PM-HSS	<b>kurz</b> <i>short</i> courte	30°		<b>334</b>
FP60135-...	3	<b>PM-HSS Schaftfräser</b> <i>PM-HSS end-mill</i> Fraise à queue PM-HSS	<b>extra kurz</b> <i>extra short</i> super courte	30°		<b>335</b>
FP60130-...	3	<b>PM-HSS Schaftfräser</b> <i>PM-HSS end-mill</i> Fraise à queue PM-HSS	<b>kurz</b> <i>short</i> courte	30°		<b>336</b>
FP601.0-...	4 - 6	<b>PM-HSS Schaftfräser</b> <i>PM-HSS end-mill</i> Fraise à queue PM-HSS	<b>kurz</b> <i>short</i> courte	30°		<b>337</b>
FP601.1-...	4 - 6	<b>PM-HSS Schaftfräser</b> <i>PM-HSS end-mill</i> Fraise à queue PM-HSS	<b>lang</b> <i>long</i> longue	30°		<b>338</b>
FP618.0-...	3 - 6	<b>PM-HSS Schruppfräser</b> <i>PM-HSS roughing end-mill</i> Fraise d'ébauche PM-HSS	<b>kurz</b> <i>short</i> courte	30°		<b>339</b>
FP618.6-...	3 - 6	<b>PM-HSS Schruppfräser</b> <i>PM-HSS roughing end-mill</i> Fraise d'ébauche PM-HSS	<b>mittellang</b> <i>mid-length</i> mi-longue	30°		<b>340</b>
FP618.1-...	3 - 6	<b>PM-HSS Schruppfräser</b> <i>PM-HSS roughing end-mill</i> Fraise d'ébauche PM-HSS	<b>lang</b> <i>long</i> longue	30°		<b>341</b>



# Übersicht pulvermetallurgische HSS-Fräser

Overview powder metal HSS millings

Aperçu des fraises HSS formées par métallurgie des poudres

Bezeichnung Description Désignation	Schneiden Flutes Tranchants	Fräser typ Type Type de fraise	Ausführung Design Modèle	Spiralwinkel Helix angle Angle d'hélice	Abb. Picture Fig.	Seite Page Page
<b>FP - Universalfräser für Stahl, rostfreien Stahl, Gusswerkstoffe / Universal cutter for steel, stainless steel and cast materials</b>						
FP619.5-...	4 - 6	PM-HSS Schruppfräser PM-HSS roughing end-mill	<b>extra kurz</b> <i>extra short</i> super courte	45°		<b>342</b>
FP619.0-...	3 - 6	PM-HSS Schruppfräser PM-HSS roughing end-mill	<b>kurz</b> <i>short</i> courte	45°		<b>343</b>
FP620.0-...	3 - 6	PM-HSS Schruppfräser PM-HSS roughing end-mill	<b>kurz</b> <i>short</i> courte	30°		<b>344</b>
FP623.1-... / FP618.1-...	4 - 5	PM-HSS Schruppfräser PM-HSS roughing end-mill	<b>extra lang</b> <i>extra long</i> extra longue	30°		<b>345</b>

## Weitere Highlights unserer Frässysteme.

*Other highlights from our milling range.*

*Autres points forts de notre gamme de fraisage.*



### **ARNO®-Frässystem DUO-MILL**

**Eckfräsen und HFC-Fräsen mit nur einem Werkzeug.**

*ARNO® milling-system DUO-MILL*

*Square shoulder and high feed (HFC) milling with just one tool.*

Système de fraisage ARNO® DUO-MILL

Fraisage à 90° et grande avance avec un seul outil



### **ARNO®-Frässystem FTA**

**Der universelle Planfräser zur Kostenreduzierung.**

*ARNO® milling-system FTA*

*Face milling tool for cost reduction.*

Système de fraisage ARNO® FTA

Le surfacage rentable !



### **ARNO®-Frässystem FOA**

**Der positiv weichschneidende Planfräser, der eine Rundplatte und eine oktagonale Wendschneidplatte in einem Plattensitz vereint.**

*ARNO® milling-system FOA*

*The positive face-milling-cutter, in which both a round and an octogonal insert can be used.*

Système de fraisage ARNO® FOA

La fraise polyvalente qui peut recevoir des plaquettes octogonales ou rondes, angle d'attaque positif pour une coupe douce et des efforts de coupe réduits au minimum.

**Weitere Informationen finden Sie unter**

*For more information see*

*Pour plus d'informations*

**ARNO®**  
**WERKZEUGE**

**www.arno.de**

# ARNO®

## WERKZEUGE

We have a passion for precision.

# AUSFÜHRUNG FP

*Design FP / Modèle FP*

## Maximale Schnittleistung und minimaler Verschleiß bei der Bearbeitung von Stahl, rostfreiem Stahl, exotischen Materialien und Gusswerkstoffen.

*Great performance and minimal wear for machining steel, stainless steel, exotics and cast materials.*

Fraisage universel pour l'usinage de l'acier, de l'acier inoxydable, des matériaux exotiques et des fontes.

Die TiAlN beschichteten Universalfräser aus pulvermetallurgischem HSS Schneidstoff sind extrem robust, zäh und verschleißfest. Dadurch ergeben sich deutlich verbesserte Standzeiten.



*These universal powder metal cutters with their TiAlN coating are extremely strong, tough and wear resistant, therefore achieving excellent tool life.*

Les fraises universelles FP en acier fritté HSS-PM TiAlN sont extrêmement solides, et résistantes à l'usure. La résilience de l'acier fritté combiné à la dureté du substrat issu des dernières technologies se traduit par une durée de vie considérablement améliorée.

PM-HSS end-mill  
Fraise d'ébauche-PM-HSS

**FP60120-...**

2 Schneiden, kurze Ausführung / 2 flutes, short design / 2 dents, version courte

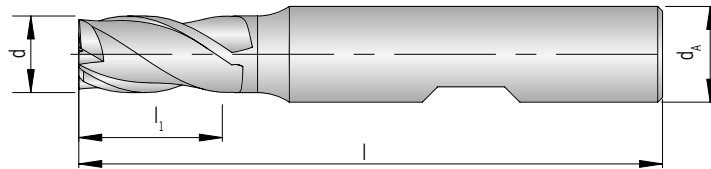
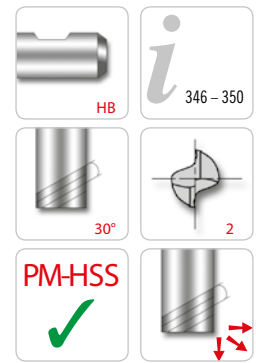

						PG 24
						beschichtet coated revêtu
Schaft DIN 6535HB Shank Tige	d e8	d <sub>A</sub> h6	l <sub>1</sub>	l	TiAIN	
FP60120-020	2	6	4	48	●	
FP60120-030	3	6	5	49	●	
FP60120-040	4	6	7	51	●	
FP60120-050	5	6	8	52	●	
FP60120-060	6	6	8	52	●	
FP60120-070	7	10	10	60	●	
FP60120-080	8	10	11	61	●	
FP60120-090	9	10	11	61	●	
FP60120-100	10	10	13	63	●	
FP60120-120	12	12	16	73	●	
FP60120-140	14	12	16	73	●	
FP60120-160	16	16	19	79	●	
FP60120-180	18	16	19	79	●	
FP60120-200	20	20	22	88	●	
FP60120-220	22	20	22	88	●	
FP60120-250	25	25	26	102	●	

P	●
M	●
K	●
N	●
S	○
H	

● Hauptanwendung  
Main application  
Application principale

○ Nebenanwendung  
Secondary application  
Application secondaire

PM-HSS end-mill  
Fraise d'ébauche-PM-HSS

**FP60121-...**

2 Schneiden, lange Ausführung / 2 flutes, long design / 2 dents, version longue

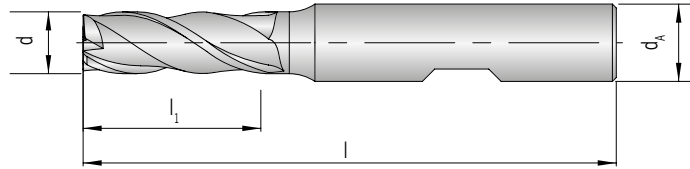
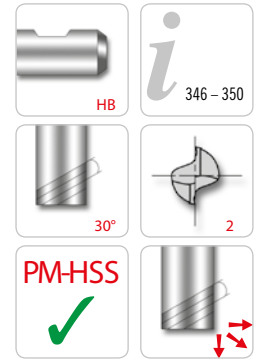

						PG 24
						beschichtet coated revêtu
Schaft DIN 6535HB Shank Tige	d e8	d <sub>A</sub> h6	l <sub>1</sub>	l	TiAIN	
FP60121-020	2	6	7	51	●	
FP60121-030	3	6	8	52	●	
FP60121-040	4	6	11	55	●	
FP60121-050	5	6	13	57	●	
FP60121-060	6	6	13	57	●	
FP60121-070	7	10	16	66	●	
FP60121-080	8	10	19	69	●	
FP60121-090	9	10	19	69	●	
FP60121-100	10	10	22	72	●	
FP60121-120	12	12	26	83	●	
FP60121-140	14	12	26	83	●	
FP60121-160	16	16	32	92	●	
FP60121-180	18	16	32	92	●	
FP60121-200	20	20	38	104	●	
FP60121-220	22	20	38	104	●	
FP60121-250	25	25	45	121	●	

P	●
M	●
K	●
N	●
S	○
H	

● Hauptanwendung  
Main application  
Application principale

○ Nebenanwendung  
Secondary application  
Application secondaire

PM-HSS ball-nose end-mill  
Fraise hémisphérique-PM-HSS

## FP60320-...

2 Schneiden, kurze Ausführung / 2 flutes, short design / 2 dents, version courte

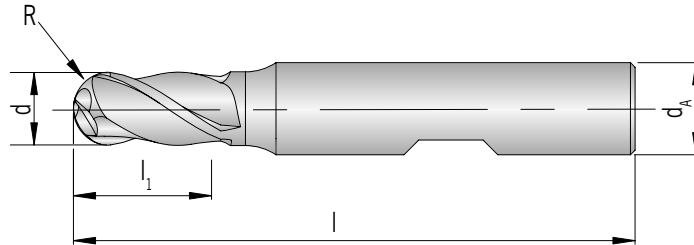
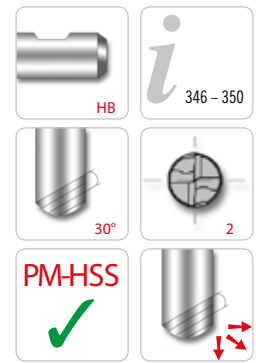

							PG 24
							beschichtet coated revêtu
Schaft DIN 6535HB Shank Tige	d -0,03	d <sub>A</sub> h6	l <sub>1</sub>	l	R ±0,02	TiAlN	
FP60320-020	2	6	4	48	1,0	●	
FP60320-030	3	6	5	49	1,5	●	
FP60320-040	4	6	7	51	2,0	●	
FP60320-050	5	6	8	52	2,5	●	
FP60320-060	6	6	8	52	3,0	●	
FP60320-070	7	10	10	60	3,5	●	
FP60320-080	8	10	11	61	4,0	●	
FP60320-090	9	10	11	61	4,5	●	
FP60320-100	10	10	13	63	5,0	●	
FP60320-120	12	12	16	73	6,0	●	
FP60320-140	14	12	16	73	7,0	●	
FP60320-160	16	16	19	79	8,0	●	
FP60320-180	18	16	19	79	9,0	●	
FP60320-200	20	20	22	88	10,0	●	
FP60320-220	22	20	22	88	11,0	●	
FP60320-250	25	25	26	102	12,5	●	

P	●
M	●
K	●
N	●
S	○
H	

● Hauptanwendung  
Main application  
Application principale

○ Nebenanwendung  
Secondary application  
Application secondaire

PM-HSS end-mill  
Fraise d'ébauche-PM-HSS

## FP60135-...

3 Schneiden, extra kurze Ausführung / 3 flutes, extra short design / 3 dents, version extra courte

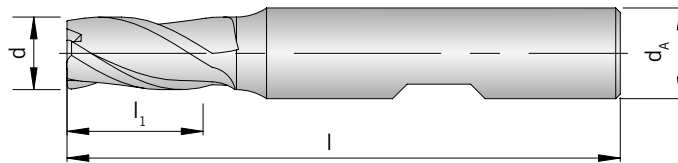
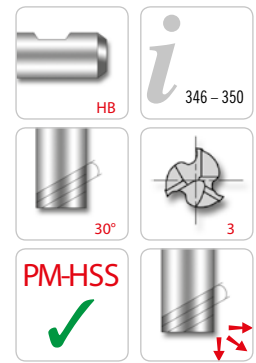

						PG 24
						beschichtet coated revêtu
Schaft DIN 6535HB Shank Tige	d e8	d <sub>A</sub> h6	l <sub>1</sub>	l		TiAIN
FP60135-020	2	6	4	48		●
FP60135-030	3	6	5	49		●
FP60135-040	4	6	7	51		●
FP60135-050	5	6	8	52		●
FP60135-060	6	6	8	52		●
FP60135-070	7	10	10	60		●
FP60135-080	8	10	11	61		●
FP60135-090	9	10	11	61		●
FP60135-100	10	10	13	63		●
FP60135-120	12	12	16	73		●
FP60135-140	14	12	16	73		●
FP60135-160	16	16	19	79		●
FP60135-180	18	16	19	79		●
FP60135-200	20	20	22	88		●
FP60135-220	22	20	22	88		●
FP60135-250	25	25	26	102		●

P	●
M	●
K	●
N	○
S	○
H	

● Hauptanwendung  
Main application  
Application principale

○ Nebenanwendung  
Secondary application  
Application secondaire

PM-HSS end-mill  
Fraise d'ébauche-PM-HSS

**FP60130-...**

3 Schneiden, kurze Ausführung / 3 flutes, short design / 3 dents, version courte

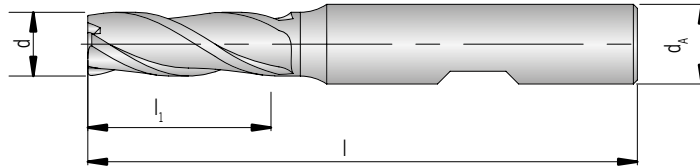
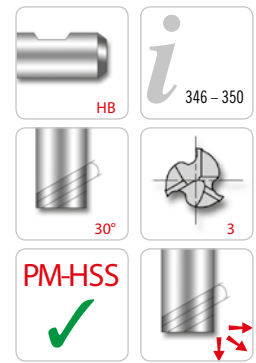

						PG 24
						beschichtet coated revêtu
Schaft DIN 6535HB Shank Tige	d e8	d <sub>A</sub> h6	l <sub>1</sub>	l	TiAIN	
FP60130-020	2	6	7	51	●	
FP60130-030	3	6	8	52	●	
FP60130-040	4	6	11	55	●	
FP60130-050	5	6	13	57	●	
FP60130-060	6	6	13	57	●	
FP60130-070	7	10	16	66	●	
FP60130-080	8	10	19	69	●	
FP60130-090	9	10	19	69	●	
FP60130-100	10	10	22	72	●	
FP60130-120	12	12	26	83	●	
FP60130-140	14	12	26	83	●	
FP60130-160	16	16	32	92	●	
FP60130-180	18	16	32	92	●	
FP60130-200	20	20	38	104	●	
FP60130-220	22	20	38	104	●	
FP60130-250	25	25	45	121	●	

P	●
M	●
K	●
N	●
S	○
H	

● Hauptanwendung  
Main application  
Application principale

○ Nebenanwendung  
Secondary application  
Application secondaire

FP



PM-HSS end-mill  
Fraise d'ébauche-PM-HSS

## FP601.0-...

4 - 6 Schneiden, kurze Ausführung / 4 - 6 flutes, short design / 4 - 6 dents, version courte

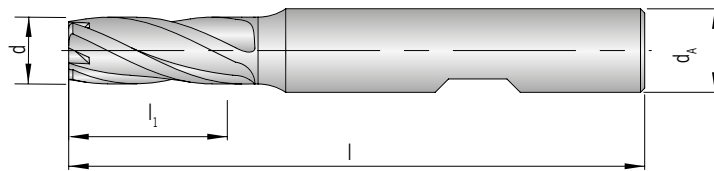
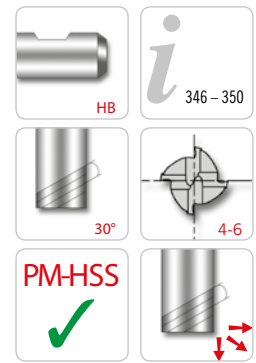

							PG 24
							beschichtet coated revêtu
Schaft DIN 6535HB Shank Tige	d +0,03	d <sub>A</sub> h6	l <sub>1</sub>	l	z	TITAIN	
FP60140-020	2	6	7	51	4	●	
FP60140-030	3	6	8	52	4	●	
FP60140-040	4	6	11	55	4	●	
FP60140-050	5	6	13	57	4	●	
FP60140-060	6	6	13	57	4	●	
FP60140-070	7	10	16	66	4	●	
FP60140-080	8	10	19	69	4	●	
FP60140-090	9	10	19	69	4	●	
FP60140-100	10	10	22	72	4	●	
FP60140-120	12	12	26	83	4	●	
FP60140-140	14	12	26	83	4	●	
FP60140-160	16	16	32	92	4	●	
FP60140-180	18	16	32	92	4	●	
FP60140-200	20	20	38	104	4	●	
FP60140-220	22	20	38	104	4	●	
FP60140-250	25	25	45	121	4	●	
FP60160-280	28	25	45	121	6	●	
FP60160-300	30	25	45	121	6	●	
FP60160-320	32	32	53	133	6	●	

P	●
M	●
K	●
N	
S	○
H	

● Hauptanwendung  
Main application  
Application principale

○ Nebenanwendung  
Secondary application  
Application secondaire

PM-HSS end-mill  
Fraise d'ébauche-PM-HSS

## FP601.1-...

4 - 6 Schneiden, lange Ausführung / 4 - 6 flutes, long design / 4 - 6 dents, version longue

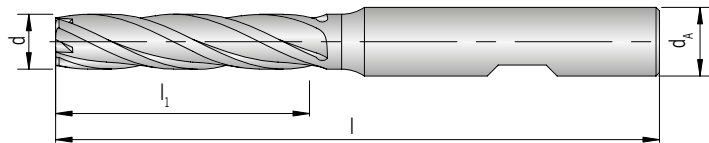
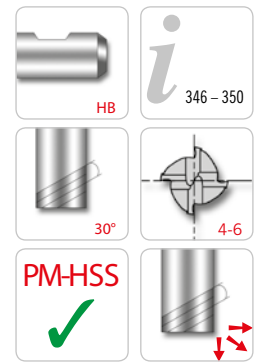

							PG 24
							beschichtet coated revêtu
Schaft DIN 6535HB Shank Tige	d +0,03	d <sub>A</sub> h6	l <sub>1</sub>	l	z	TITAIN	
FP60141-020	2	6	10	54	4	●	
FP60141-030	3	6	12	56	4	●	
FP60141-040	4	6	19	63	4	●	
FP60141-050	5	6	24	68	4	●	
FP60141-060	6	6	24	68	4	●	
FP60141-070	7	10	30	80	4	●	
FP60141-080	8	10	38	88	4	●	
FP60141-090	9	10	38	88	4	●	
FP60141-100	10	10	45	95	4	●	
FP60141-120	12	12	53	110	4	●	
FP60141-140	14	12	53	110	4	●	
FP60141-160	16	16	63	123	4	●	
FP60141-180	18	16	63	123	4	●	
FP60141-200	20	20	75	141	4	●	
FP60141-220	22	20	75	141	4	●	
FP60141-250	25	25	90	166	4	●	
FP60161-280	28	25	90	166	6	●	
FP60161-300	30	25	90	166	6	●	
FP60161-320	32	32	106	186	6	●	

P	●
M	●
K	●
N	
S	○
H	

● Hauptanwendung  
Main application  
Application principale

○ Nebenanwendung  
Secondary application  
Application secondaire

FP

PM-HSS roughing end-mill  
Fraise d'ébauche-PM-HSS

## FP618.0-...

3 - 6 Schneiden, kurze Ausführung / 3 - 6 flutes, short design / 3 - 6 dents, version courte

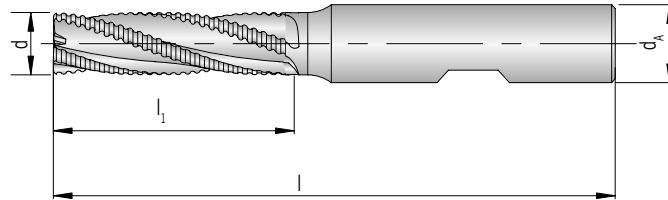
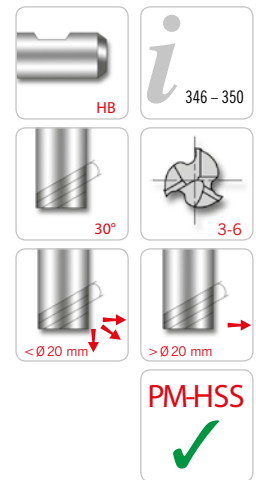

							PG 24
							beschichtet coated revêtu
Schaft DIN 6535HB Shank Tige	d js12	d <sub>A</sub> h6	l <sub>1</sub>	l	z	TiAIN	
FP61830-060	6	6	13	57	3	●	
FP61830-070	7	10	16	66	3	●	
FP61830-080	8	10	19	69	3	●	
FP61830-090	9	10	19	69	3	●	
FP61840-100	10	10	22	72	4	●	
FP61840-120	12	12	26	83	4	●	
FP61840-140	14	12	26	83	4	●	
FP61840-160	16	16	32	92	4	●	
FP61840-180	18	16	32	92	4	●	
FP61840-200	20	20	38	104	4	●	
FP61850-220	22	20	38	104	5	●	
FP61850-250	25	25	45	121	5	●	
FP61860-280	28	25	45	121	6	●	
FP61860-300	30	25	45	121	6	●	
FP61860-320	32	32	53	133	6	●	

P	●
M	●
K	●
N	○
S	○
H	○

● Hauptanwendung  
Main application  
Application principale  
○ Nebenanwendung  
Secondary application  
Application secondaire

PM-HSS roughing end-mill  
Fraise d'ébauche-PM-HSS

FP618.6-...

3 - 6 Schneiden, mittellange Ausführung / 3 - 6 flutes, mid-length design / 3 - 6 dents, version mi-longue

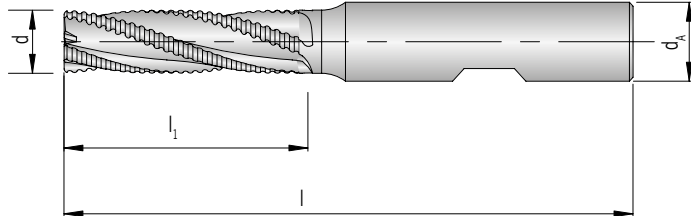

							PG 24
							beschichtet coated revêtu
Schaft DIN 6535HB Shank Tige	d js12	d <sub>A</sub> h6	l <sub>1</sub>	l	z	TiAIN	
FP61836-060	6	6	19	63	3	●	
FP61836-070	7	6	19	63	3	●	
FP61836-080	8	10	28	74	3	●	
FP61836-090	9	10	28	74	3	●	
FP61846-100	10	10	35	84	4	●	
FP61846-120	12	12	40	97	4	●	
FP61846-140	14	12	40	97	4	●	
FP61846-160	16	16	48	108	4	●	
FP61846-180	18	16	48	108	4	●	
FP61846-200	20	20	58	122	4	●	
FP61856-220	22	20	58	122	5	●	
FP61856-250	25	25	68	144	5	●	
FP61866-280	28	25	68	144	6	●	
FP61866-300	30	25	68	144	6	●	
FP61866-320	32	32	78	158	6	●	

P	●
M	●
K	●
N	○
S	○
H	○

● Hauptanwendung  
Main application  
Application principale  
○ Nebenanwendung  
Secondary application  
Application secondaire

PM-HSS roughing end-mill  
Fraise d'ébauche-PM-HSS

## FP618.1-...

3 - 6 Schneiden, lange Ausführung / 3 - 6 flutes, long design / 3 - 6 dents, version longue

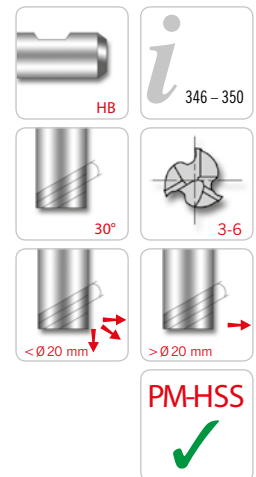
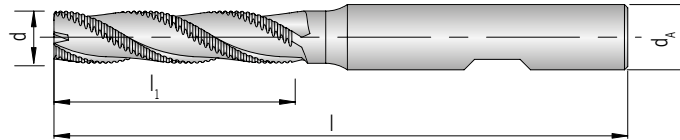

							PG 24
							beschichtet coated revêtu
Schaft DIN 6535HB Shank Tige	d js12	d <sub>A</sub> h6	l <sub>1</sub>	l	z	TiAIN	
FP61831-060	6	6	24	68	3	●	
FP61831-070	7	10	30	80	3	●	
FP61831-080	8	10	38	88	3	●	
FP61831-090	9	10	38	88	3	●	
FP61841-100	10	10	45	95	4	●	
FP61841-120	12	12	53	110	4	●	
FP61841-140	14	12	53	110	4	●	
FP61841-160	16	16	63	123	4	●	
FP61841-180	18	16	63	123	4	●	
FP61841-200	20	20	75	141	4	●	
FP61851-220	22	20	75	141	5	●	
FP61851-250	25	25	90	166	5	●	
FP61861-280	28	25	90	166	6	●	
FP61861-300	30	25	90	166	6	●	
FP61861-320	32	32	106	186	6	●	

P	●
M	●
K	●
N	○
S	○
H	○

● Hauptanwendung  
Main application  
Application principale  
○ Nebenanwendung  
Secondary application  
Application secondaire

PM-HSS roughing end-mill  
Fraise d'ébauche-PM-HSS

## FP619.5-...

4 - 6 Schneiden, extra kurze Ausführung / 4 - 6 flutes, extra short design / 4 - 6 dents, version extra courte

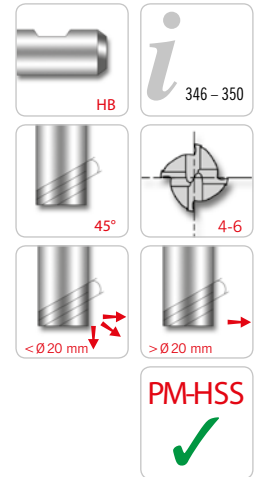
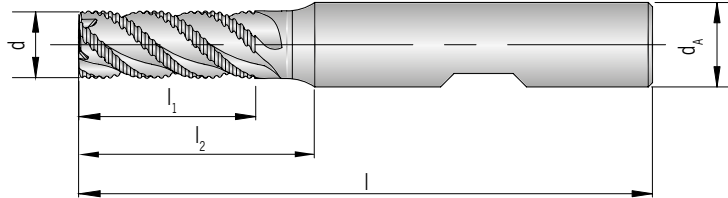

								PG 24
								beschichtet coated revêtu
Schaft DIN 6535HB Shank Tige	d js12	d <sub>A</sub> h6	l <sub>1</sub>	l <sub>2</sub>	l	z	TITAIN	
FP61945-060	6	6	8	-	52	4	●	
FP61945-080	8	10	11	-	61	4	●	
FP61945-100	10	10	13	23	63	4	●	
FP61945-120	12	12	16	28	73	4	●	
FP61955-140	14	12	16	-	73	5	●	
FP61955-160	16	16	19	31	79	5	●	
FP61965-180	18	16	19	-	79	6	●	
FP61965-200	20	20	22	38	88	6	●	
FP61965-250	25	25	26	46	102	6	●	

P	●
M	●
K	●
N	
S	○
H	

● Hauptanwendung  
Main application  
Application principale

○ Nebenanwendung  
Secondary application  
Application secondaire

PM-HSS roughing end-mill  
Fraise d'ébauche-PM-HSS

## FP619.0-...

3 - 6 Schneiden, kurze Ausführung / 3 - 6 flutes, short design / 3 - 6 dents, version courte

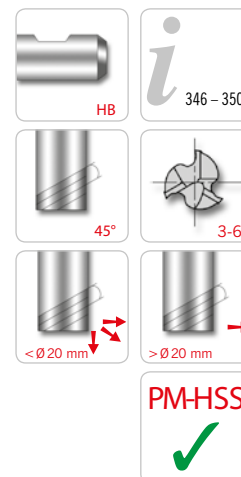
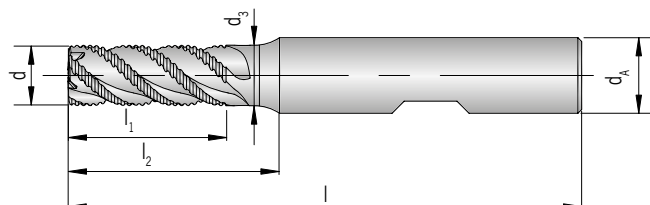

									PG 24
									beschichtet coated revêtu
Schaft DIN 6535HB Shank Tige	d js12	d <sub>A</sub> h6	d <sub>3</sub>	l <sub>1</sub>	l <sub>2</sub>	l	z	TITAIN	
FP61930-040	4	6	-	11	-	57	3	●	
FP61940-050	5	6	-	13	-	57	4	●	
FP61940-060	6	6	-	13	-	57	4	●	
FP61940-070	7	10	-	16	-	66	4	●	
FP61940-080	8	10	-	19	-	69	4	●	
FP61940-090	9	10	-	19	-	69	4	●	
FP61940-100	10	10	9,5	22	31	72	4	●	
FP61940-110	11	12	10,5	22	27	80	4	●	
FP61940-120	12	12	11,5	26	37	83	4	●	
FP61940-130	13	12	-	26	-	84	4	●	
FP61950-140	14	12	-	26	-	83	5	●	
FP61950-150	15	12	-	26	-	85	5	●	
FP61950-160	16	16	15,0	32	44	92	5	●	
FP61960-180	18	16	-	32	-	92	6	●	
FP61960-200	20	20	19,0	38	54	104	6	●	
FP61960-250	25	25	24,0	45	63	121	6	●	

P	●
M	●
K	●
N	●
S	○
H	

● Hauptanwendung  
Main application  
Application principale

○ Nebenanwendung  
Secondary application  
Application secondaire

PM-HSS roughing end-mill  
Fraise d'ébauche-PM-HSS

## FP620.0-...

3 - 6 Schneiden, kurze Ausführung / 3 - 6 flutes, short design / 3 - 6 dents, version courte

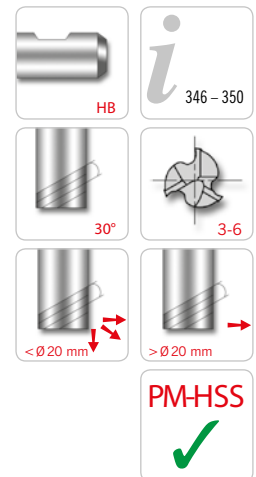
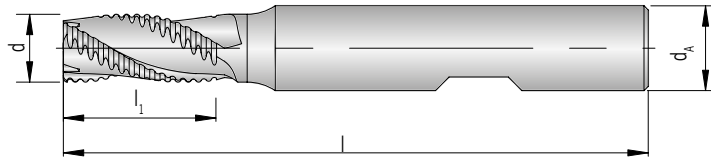

							PG 24
							beschichtet coated revêtu
Schaft DIN 6535HB Shank Tige	d js12	d <sub>A</sub> h6	l <sub>1</sub>	l	z	TiAIN	
FP62030-060	6	6	13	57	3	●	
FP62030-070	7	10	16	66	3	●	
FP62030-080	8	10	19	69	3	●	
FP62030-090	9	10	19	69	3	●	
FP62040-100	10	10	22	72	4	●	
FP62040-120	12	12	26	83	4	●	
FP62040-140	14	12	26	83	4	●	
FP62040-160	16	16	32	92	4	●	
FP62040-180	18	16	32	92	4	●	
FP62040-200	20	20	38	104	4	●	
FP62050-220	22	20	38	104	5	●	
FP62050-250	25	25	45	121	5	●	
FP62060-300	30	25	45	121	6	●	
FP62060-320	32	32	53	133	6	●	

P	●
M	●
K	●
N	
S	○
H	

● Hauptanwendung  
Main application  
Application principale

○ Nebenanwendung  
Secondary application  
Application secondaire

FP



PM-HSS roughing end-mill  
Fraise d'ébauche-PM-HSS

## FP623.1-...

4-5 Schneiden, extra lange Ausführung / 4-5 flutes, extra long design / 4 - 5 dents, version extra longue

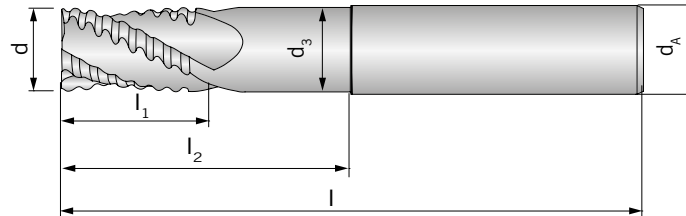
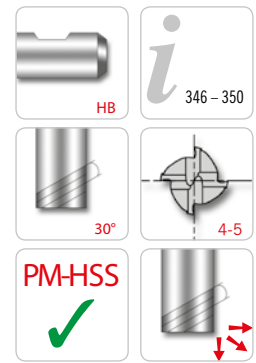

								PG 24
								beschichtet coated revêtu
Schaft DIN 6535HB Shank Tige	d js12	d <sub>A</sub> h6	d <sub>3</sub>	l <sub>1</sub>	l <sub>2</sub>	l	z	TiAIN
FP62341-100	10	10	8,5	22	69	110	4	●
FP62341-120	12	12	10,5	26	78	125	4	●
FP62341-160	16	16	14,0	32	87	138	4	●
FP62341-200	20	20	18,0	38	108	160	4	●
FP62351-250	25	25	23,0	45	155	216	5	●

P	●
M	●
K	●
N	
S	○
H	

● **Hauptanwendung**  
Main application  
Application principale

○ **Nebenanwendung**  
Secondary application  
Application secondaire

Werkstoff- gruppe	Gliederung der Werkstoffhauptgruppen und Kennbuchstaben		Brinell-Härte	Zugfestigkeit Rm (N/mm <sup>2</sup> )	Zerspanungsgruppe	Korrekturfaktor	Schnittgeschwindigkeit V <sub>c</sub> (m/min)	
							PM-HSS	TiAlN
<b>P</b>	Unlegierter Stahl	C ≤ 0,25 % geglüht	125	428	P1	1,2	60 - 73 - 85	
		C > 0,25 ... ≤ 0,55 % geglüht	190	639	P2	1,2	45 - 53 - 60	
		C > 0,25 ... ≤ 0,55 % vergütet	210	708	P3	1,2	45 - 53 - 60	
		C > 0,55 % geglüht	190	639	P4	1,2	45 - 53 - 60	
		C > 0,55 % vergütet	300	1013	P5	1,0	30 - 35 - 40	
		Automatenstahl (kurzspanend) geglüht	220	745	P6	1,2	50 - 60 - 70	
	Niedrig legierter Stahl	geglüht	175	591	P7	1,2	40 - 50 - 60	
		vergütet	300	1013	P8	1,0	40 - 50 - 60	
		vergütet	380	1282	P9	0,8	30 - 35 - 40	
		vergütet	430	1477	P10	0,8	30 - 35 - 40	
	Hochlegierter Stahl und hochlegierter Werkzeugstahl	geglüht	200	675	P11	1,2	40 - 50 - 60	
		gehärtet und angelassen	300	1013	P12	1,0	30 - 35 - 40	
		gehärtet und angelassen	400	1361	P13	0,8	20 - 25 - 30	
	Nichtrostender Stahl	ferritisch / martensitisch, geglüht	200	675	P14	1,0	20 - 25 - 30	
		martensitisch, vergütet	330	1114	P15		-	
<b>M</b>	Nichtrostender Stahl	austenitisch, abgeschreckt	200	675	M1	1,0	20 - 25 - 30	
		austenitisch, ausscheidungsgehärtet (PH)	300	1013	M2	0,9	15 - 18 - 20	
		austenitisch-ferritisch, Duplex	230	778	M3	1,0	10 - 13 - 15	
<b>K</b>	Temperguss	ferritisch	200	675	K1	1,0	30 - 35 - 40	
		perritisch	260	867	K2	0,8	25 - 30 - 35	
	Grauguss	niedrige Festigkeit	180	602	K3	1,0	35 - 43 - 50	
		hohe Festigkeit / austenitisch	245	825	K4	1,0	25 - 30 - 35	
	Gusseisen mit Kugelgraphit	ferritisch	155	518	K5	1,0	30 - 35 - 40	
		perritisch	265	885	K6	1,0	30 - 35 - 40	
	GGV (CGI)		200	675	K7	1,0	30 - 35 - 40	
<b>N</b>	Aluminium-Knetlegierungen	nicht aushärtbar	30	-	N1		-	
		aushärtbar, ausgehärtet	100	343	N2		-	
	Aluminium-Gusslegierungen	≤ 12 % Si, nicht aushärtbar	75	260	N3		-	
		≤ 12 % Si, aushärtbar, ausgehärtet	90	314	N4		-	
	Magnesiumlegierungen	> 12 % Si, nicht aushärtbar	130	447	N5		-	
			70	250	N6		-	
	Kupfer und Kupferlegierungen (Bronze / Messing)	unlegiert, Elektrolytkupfer	100	343	N7		-	
		Messing, Bronze, Rotguss	90	314	N8		-	
		Cu-Legierung, kurzspanend	110	382	N9		-	
		hochfest, Ampco	300	1013	N10		-	
Nichtmetallische Werkstoffe	Thermoplaste (ohne abrasive Füllstoffe)	-	-	N11		-		
	Duroplaste (ohne abrasive Füllstoffe)	-	-	N12		-		
	Kunststoff glasfaserverstärkt GFRP	-	-	N13		-		
	Kunststoff kohlefaserverstärkt CFRP	-	-	N14		-		
	Kunststoff aramidfaserverstärkt AFRP	-	-	N15		-		
	Graphit (technisch)	80 Shore	-	N16		-		
<b>S</b>	Warmfeste Legierungen	Fe-Basis geglüht	200	675	S1		-	
		ausgehärtet	280	943	S2		-	
		Ni- oder Co-Basis geglüht	250	839	S3	0,9	10 - 13 - 16	
		ausgehärtet	350	1177	S4	0,7	9 - 12 - 14	
		gegossen	320	1076	S5	0,7	9 - 12 - 14	
	Titanlegierungen	Reintitan	200	675	S6	1,0	20 - 25 - 30	
		α- und β-Legierungen, ausgehärtet	375	1262	S7		-	
		β-Legierungen	410	1396	S8		-	
	Wolframlegierungen		300	1013	S9	1,1	10 - 15 - 20	
	Molybdänlegierungen		300	1013	S10		-	
<b>H</b>	Gehärteter Stahl	gehärtet und angelassen	50 HRC	-	H1		-	
		gehärtet und angelassen	55 HRC	-	H2		-	
		gehärtet und angelassen	60 HRC	-	H3		-	
	Gehärtetes Gusseisen	gehärtet und angelassen	55 HRC	-	H4		-	

Die Tabellenwerte sind Richtwerte. Es kann notwendig sein, die Werte den jeweiligen Bearbeitungsumständen anzupassen.

Material group	Structure of the material groups and identification letters		Brinell hardness HB	Tensile strength Rm (N/mm <sup>2</sup> )	Chipping group	Correction factor	Cutting speed V <sub>c</sub> (m/min)	
							PM-HSS	TAIN
P	Unalloyed steel	C ≤ 0.25 % annealed	125	428	P1	1,2	60 - 73 - 85	
		C > 0.25 ... ≤ 0.55 % annealed	190	639	P2	1,2	45 - 53 - 60	
		C > 0.25 ... ≤ 0.55 % hardened and tempered	210	708	P3	1,2	45 - 53 - 60	
		C > 0.55 % annealed	190	639	P4	1,2	45 - 53 - 60	
		C > 0.55 % hardened and tempered	300	1013	P5	1,0	30 - 35 - 40	
		Machining steel (short-chipping) tempered	220	745	P6	1,2	50 - 60 - 70	
	Low alloyed steel	annealed	175	591	P7	1,2	40 - 50 - 60	
		hardened and tempered	300	1013	P8	1,0	40 - 50 - 60	
		hardened and tempered	380	1282	P9	0,8	30 - 35 - 40	
		hardened and tempered	430	1477	P10	0,8	30 - 35 - 40	
	High alloyed steel and high alloyed tool steel	annealed	200	675	P11	1,2	40 - 50 - 60	
		hardened	300	1013	P12	1,0	30 - 35 - 40	
		hardened	400	1361	P13	0,8	20 - 25 - 30	
	Stainless steel	ferritic / martensitic, annealed	200	675	P14	1,0	20 - 25 - 30	
		martensitic, hardened and tempered	330	1114	P15		-	
M	Stainless steel	austenitic, chilled	200	675	M1	1,0	20 - 25 - 30	
		austenitic, precipitation-hardened (PH)	300	1013	M2	0,9	15 - 18 - 20	
		austenitic-ferritic, Duplex	230	778	M3	1,0	10 - 13 - 15	
K	Malleable cast iron	ferritic	200	675	K1	1,0	30 - 35 - 40	
		pearlitic	260	867	K2	0,8	25 - 30 - 35	
	Cast iron	low tensile strength	180	602	K3	1,0	35 - 43 - 50	
		high tensile strength / austenitic	245	825	K4	1,0	25 - 30 - 35	
	Cast iron with nodular graphite	ferritic	155	518	K5	1,0	30 - 35 - 40	
		pearlitic	265	885	K6	1,0	30 - 35 - 40	
GGV (CGI)		200	675	K7	1,0	30 - 35 - 40		
N	Aluminium alloys long chipping	not heat treatable	30	-	N1		-	
		heat treatable, heat treated	100	343	N2		-	
	Casted aluminium alloys	≤ 12 % Si, not heat treatable	75	260	N3		-	
		≤ 12 % Si, aushärtbar, ausgehärtet	90	314	N4		-	
		> 12 % Si, not heat treatable	130	447	N5		-	
	Magnesium alloys		70	250	N6		-	
	Copper and copper alloys (Brass / Bronze)	Unalloyed, elektrolyte copper	100	343	N7		-	
		Brass, Bronze	90	314	N8		-	
		Cu-alloys, short-chipping	110	382	N9		-	
		High-tensile, Ampco	300	1013	N10		-	
	Non-ferrous materials	Lead alloys (without abrasive filling material)	-	-	N11		-	
		Duroplastic (without abrasive filling material)	-	-	N12		-	
		Plastic glas fibre reinforced GFRP	-	-	N13		-	
		Plastic carbon fibre reinforced CFRP	-	-	N14		-	
		Plastic aramid fibre reinforced AFRP	-	-	N15		-	
		Graphite (tech.)	80 Shore	-	N16		-	
S	High temperature resistant alloys	Fe-Basis	annealed	200	675	S1		-
			heat treated	280	943	S2		-
		Ni- or Co-alloyed	annealed	250	839	S3	0,9	10 - 13 - 16
			heat treated	350	1177	S4	0,7	9 - 12 - 14
			casting	320	1076	S5	0,7	9 - 12 - 14
	Titanium alloys	Pure titan	200	675	S6	1,0	20 - 25 - 30	
		α- and β-alloys, heat treated	375	1262	S7		-	
	Wolfram alloys	β-alloys	410	1396	S8		-	
			300	1013	S9	1,1	10 - 15 - 20	
	Molybdän alloys		300	1013	S10		-	
H	Hardened steel	hardened	50 HRC	-	H1		-	
		hardened	55 HRC	-	H2		-	
		hardened	60 HRC	-	H3		-	
	Hardened cast iron	hardened	55 HRC	-	H4		-	

The recommended cutting data are only approximate values. It may be necessary to adjust them to each individual machining application.

ISO	Matériaux	Dureté Brinell	Résistance (N/mm <sup>2</sup> )	Groupe d'usinage	facteur de correction	Vitesse de coupe Vc (m/min)	
						PM-HSS	TAIN
P	Acier non allié	C ≤ 0,25 % recuit	125	428	P1	1,2	60 - 73 - 85
		C > 0,25 ... ≤ 0,55 % recuit	190	639	P2	1,2	45 - 53 - 60
		C > 0,25 ... ≤ 0,55 % traité	210	708	P3	1,2	45 - 53 - 60
		C > 0,55 % recuit	190	639	P4	1,2	45 - 53 - 60
		C > 0,55 % traité	300	1013	P5	1,0	30 - 35 - 40
		Aciers de décolletage (à copeaux courts) recuit	220	745	P6	1,2	50 - 60 - 70
	Acier faiblement allié	recuit	175	591	P7	1,2	40 - 50 - 60
		traité	300	1013	P8	1,0	40 - 50 - 60
		traité	380	1282	P9	0,8	30 - 35 - 40
		traité	430	1477	P10	0,8	30 - 35 - 40
	Acier allié et acier outil allié	recuit	200	675	P11	1,2	40 - 50 - 60
		trempe et revenu	300	1013	P12	1,0	30 - 35 - 40
		trempe et revenu	400	1361	P13	0,8	20 - 25 - 30
	Acier inox	ferritique, martensitique, recuit	200	675	P14	1,0	20 - 25 - 30
		martensitique, traité	330	1114	P15		-
M	Acier inox	austénitique	200	675	M1	1,0	20 - 25 - 30
		austénitique	300	1013	M2	0,9	15 - 18 - 20
		austénitique-ferritique, Duplex	230	778	M3	1,0	10 - 13 - 15
K	Fonte malléable	ferritique	200	675	K1	1,0	30 - 35 - 40
		perlitique	260	867	K2	0,8	25 - 30 - 35
	Fonte grise	faible résistance	180	602	K3	1,0	35 - 43 - 50
		haute résistance / austénitique	245	825	K4	1,0	25 - 30 - 35
	Fonte à Graphite sphéroïdale	ferritique	155	518	K5	1,0	30 - 35 - 40
		perlitique	265	885	K6	1,0	30 - 35 - 40
GGV (CGI)		200	675	K7	1,0	30 - 35 - 40	
N	Alliages de fonderie d'aluminium	ne pouvant pas subir un durcissement	30	-	N1		-
		pouvant subir un durcissement, durci	100	343	N2		-
		≤ 12 % Si, ne pouvant pas subir de durcissement	75	260	N3		-
	Alliage de fonte d'aluminium	≤ 12 % Si, pouvant subir un durcissement, durci	90	314	N4		-
		> 12 % Si, ne pouvant pas subir de durcissement	130	447	N5		-
	Alliage de Magnésium		70	250	N6		-
	Cuivre et alliage de cuivre (bronze / laiton)	non allié, cuivre électrolytique	100	343	N7		-
		Laiton, bronze, fonte rouge	90	314	N8		-
		Alliage de cuivre à copeaux courts	110	382	N9		-
		forte résistance, Ampco	300	1013	N10		-
Matériaux non métalliques	Thermoplaste (sans agents de charge abrasives)	-	-	N11		-	
	Duroplaste (sans agents de charge abrasives)	-	-	N12		-	
	Matière plastique renforcée de fibres de verre GFRP	-	-	N13		-	
	Matière plastique renforcé composite CFRP	-	-	N14		-	
	Plastique renforcé fibre aramide AFRP	-	-	N15		-	
	Graphite	80 Shore	-	N16		-	
S	Alliages réfractaires	à base de Fe recuit	200	675	S1		-
		à base de Fe durci	280	943	S2		-
		à base de Fe recuit	250	839	S3	0,9	10 - 13 - 16
		à base Ni ou Co durci	350	1177	S4	0,7	9 - 12 - 14
		à base Ni ou Co jeter	320	1076	S5	0,7	9 - 12 - 14
	Alliage de titane	Titane pur	200	675	S6	1,0	20 - 25 - 30
		Alliages Alpha + Beta, trempé	375	1262	S7		-
		Alliages Beta	410	1396	S8		-
	Alliage de tungstène		300	1013	S9	1,1	10 - 15 - 20
	Alliage de molybdène		300	1013	S10		-
H	Acier trempé	trempe et revenu	50 HRC	-	H1		-
		trempe et revenu	55 HRC	-	H2		-
		trempe et revenu	60 HRC	-	H3		-
	Fonte durci	trempe et revenu	55 HRC	-	H4		-

Les valeurs du tableau sont indicatives. Il peut être nécessaire de les adapter aux conditions d'usinage respectives.

Vorschub pro Zahn  $f_z$  [mm]

Feed per tooth  $f_z$  [mm]

Avance par dent  $f_z$  [mm]

Vollmaßfräsen (in einem Schnitt) Full slot milling (in one cut) Fraisage de rainure en un passage		Untermaßfräsen (im Rahmen) Profile slot milling (internal profile milling) Fraisage de rainure (dans le cadre)		Bohrfräsen Circular ramping Perçage	
beschichtet / coated / à revêtement		beschichtet / coated / à revêtement		beschichtet / coated / à revêtement	beschichtet / coated / à revêtement
$d_1$ [mm]	$f_z$ [mm]	Schuppen / Roughing $f_z$ [mm]	Schichten / Fine cutting $f_z$ [mm]	$f_z$ [mm]	$f_z$ [mm]
	1,5	0,005	0,005	0,007	0,002
2,0	0,006	0,006	0,009	0,003	0,002
3,0	0,010	0,010	0,016	0,005	0,003
4,0	0,013	0,013	0,024	0,007	0,004
5,0	0,017	0,017	0,033	0,009	0,006
6,0	0,022	0,022	0,043	0,011	0,007
7,0	0,026	0,025	0,051	0,012	0,008
8,0	0,029	0,029	0,061	0,014	0,010
9,0	0,032	0,032	0,071	0,016	0,011
10,0	0,037	0,037	0,082	0,019	0,012
12,0	0,044	0,044	0,101	0,022	0,015
14,0	0,054	0,054	0,118	0,027	0,018
16,0	0,062	0,062	0,135	0,031	0,021
18,0	0,072	0,072	0,151	0,036	0,024
20,0	0,078	0,078	0,167	0,039	0,026
22,0	0,088	0,088	0,184	0,044	0,029
25,0	0,098	0,098	0,208	0,049	0,033
28,0	0,108	0,108	0,217	0,052	0,039
30,0	0,120	0,120	0,230	0,060	0,041
32,0	0,135	0,135	0,251	0,071	0,048
40,0	0,150	0,150	0,260	0,070	0,050

Achtung: Optimale Ergebnisse werden im Gleichlauffräsen erzielt.  
Attention: For optimal results it is recommended to climb mill.  
Attention: Le fraisage en avalant est recommandé pour obtenir des résultats optimaux.

Generelle Berechnungsformeln: / General rule: / Formules de calcul générales :  
Vorschub pro Zahn / Feed per tooth / Avance par dent =  $f_z \cdot K_f$  (fz)

Bohrvorschub (Fräsen in axialer Richtung): = Tabellenwert / Zähnezahl  
For axial plunge milling: = Table value / Number of teeth  
Avance de perçage (fraisage dans le sens axial) : = valeur du tableau / nombre de dents

Vorschub pro Zahn  $f_z$  [mm]

Feed per tooth  $f_z$  [mm]

Avance par dent  $f_z$  [mm]

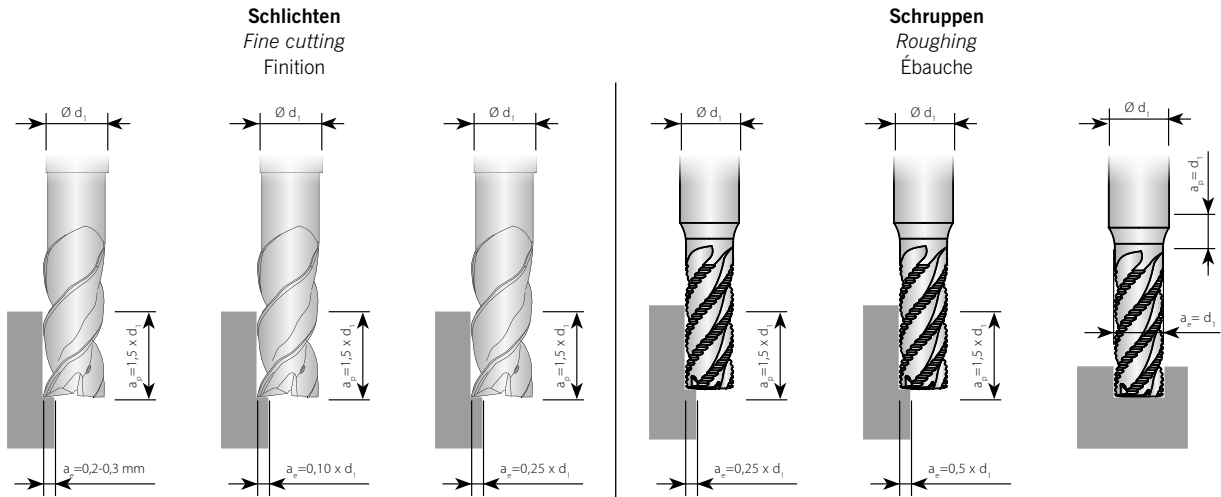

$d_1$ [mm]	beschichtet / coated / à revêtement			beschichtet / coated / à revêtement		
	aSchlichtgeometrie / Geometry for peripheral milling			Schruppgeometrie / Geometry for roughing		
	$f_z$ [mm]	$f_z$ [mm]	$f_z$ [mm]	$f_z$ [mm]	$f_z$ [mm]	$f_z$ [mm]
1,0	0,005	0,005	0,005	0,005	0,005	0,005
1,5	0,007	0,007	0,007	0,007	0,007	0,007
2,0	0,009	0,009	0,009	0,010	0,010	0,008
3,0	0,012	0,012	0,010	0,013	0,012	0,010
4,0	0,018	0,015	0,014	0,016	0,014	0,012
5,0	0,026	0,020	0,015	0,021	0,018	0,016
6,0	0,035	0,024	0,017	0,027	0,022	0,019
7,0	0,045	0,028	0,021	0,031	0,027	0,022
8,0	0,051	0,032	0,022	0,036	0,030	0,026
9,0	0,061	0,036	0,025	0,052	0,034	0,031
10,0	0,072	0,041	0,028	0,047	0,039	0,034
12,0	0,091	0,049	0,034	0,057	0,047	0,041
14,0	0,106	0,059	0,041	0,069	0,058	0,050
16,0	0,121	0,067	0,046	0,079	0,066	0,057
18,0	0,136	0,077	0,053	0,093	0,078	0,067
20,0	0,151	0,083	0,057	0,101	0,084	0,073
22,0	0,166	0,094	0,065	0,114	0,096	0,082
25,0	0,188	0,104	0,072	0,129	0,108	0,093
28,0	0,210	0,120	0,083	0,150	0,125	0,108
30,0	0,225	0,127	0,088	0,161	0,135	0,116
32,0	0,240	0,137	0,094	0,173	0,145	0,125
40,0	0,240	0,170	0,120	0,200	0,160	0,140

Achtung: Optimale Ergebnisse werden im Gleichlaufräsen erzielt.  
 Attention: For optimal results it is recommended to climb mill.  
 Attention: Le fraisage en avalant est recommandé pour obtenir des résultats optimaux.

Generelle Berechnungsformeln: / General rule: / Formules de calcul générales :  
 Vorschub pro Zahn / Feed per tooth / Avance par dent =  $f_z \cdot K_f$  (fz)

Bohrvorschub (Fräsen in axialer Richtung): = Tabellenwert / Zähnezahl  
 For axial plunge milling: = Table value / Number of teeth  
 Avance de perçage (fraisage dans le sens axial): = valeur du tableau / nombre de dents

# ARNO®

## WERKZEUGE

We have a passion for precision.

## VHM-GEWINDEFRÄSER

*Solid carbide thread milling cutters*  
Fraise à fileter en carbure monobloc

### Ausführung

- AFT - Gewindefräser ISO-Innengewinde
- Gewindefräser UNC-Innengewinde
- Gewindefräser UNF-Innengewinde
- Gewindefräser BSP(G)-Innengewinde
- Gewindefräser NPT-Innengewinde

### Design

- AFT - Thread milling cutter ISO - internal thread
- Thread milling cutter UNC - internal thread
- Thread milling cutter UNF - internal thread
- Thread milling cutter BSP(G) - internal thread
- Thread milling cutter NPT - internal thread

### Modèle

- AFT - Fraise à fileter filetage intérieur ISO
- Fraise à fileter filetage intérieur UNC
- Fraise à fileter filetage intérieur UNF
- Fraise à fileter filetage intérieur BSP(G)
- Fraise à fileter filetage intérieur NPT



# Übersicht VHM-Gewindefräser







Overview solid carbide thread milling cutter  
Aperçu fraise à fileter en carbure monobloc

Bezeichnung Description Désignation	Schneiden Flutes Tranchants	Fräser Type Type de fraise	Ausführung Design Modèle	Spiralwinkel Helix angle Angle d'hélice	Abb. Picture Fig.	Seite Page Page
<b>AFT - Gewindefräser ISO-Innengewinde / Thread milling cutter ISO-internal thread / AFT - fraise à fileter filetage intérieur ISO</b>						
AFT525.1-ISO...	3 - 5	<b>Gewindefräser ISO - Innengewinde</b> Thread milling cutter ISO - internal thread Fraise à fileter filetage intérieur ISO	<b>mittellang</b> medium length mi-longue	15°		<b>356</b>
AFT525.1-ISO...IK	3 - 5	<b>Gewindefräser ISO - Innengewinde</b> Thread milling cutter ISO - internal thread Fraise à fileter filetage intérieur ISO	<b>mittellang mit Innenkühlung</b> medium length with through tool coolant mi-longue avec refroidissement interne	15°		<b>357</b>
AFT525.1-ISO...IK-F	3 - 4	<b>Gewindefräser ISO - Innengewinde</b> Thread milling cutter ISO - internal thread Fraise à fileter filetage intérieur ISO	<b>mittellang mit Innenkühlung und Fase</b> medium length with through tool coolant and chamfers mi-longue avec refroidissement interne et chanfrein	15°		<b>358</b>
AFT525.0-ISO...	3 - 5	<b>Gewindefräser ISO - Innengewinde</b> Thread milling cutter ISO - internal thread Fraise à fileter filetage intérieur ISO	<b>kurz</b> short courte	15°		<b>359</b>
AFT525.0-ISO...-IK	3 - 5	<b>Gewindefräser ISO - Innengewinde</b> Thread milling cutter ISO - internal thread Fraise à fileter filetage intérieur ISO	<b>kurz mit Innenkühlung</b> short with through tool coolant courte avec refroidissement interne	15°		<b>360</b>
AFT525.0-ISO...-IK-F	3 - 5	<b>Gewindefräser ISO - Innengewinde</b> Thread milling cutter ISO - internal thread Fraise à fileter filetage intérieur ISO	<b>kurz mit Innenkühlung und Fase</b> short with through tool coolant and chamfers courte avec refroidissement interne et chanfrein	15°		<b>361</b>
AFT52534-ISO...	3	<b>Gewindefräser ISO - Innengewinde</b> Thread milling cutter ISO - internal thread Fraise à fileter filetage intérieur ISO	<b>mini</b> mini	15°		<b>362</b>
AFT52621-ISO...-IK-F	2	<b>Gewindefräser ISO - Innengewinde</b> Thread milling cutter ISO - internal thread Fraise à fileter filetage intérieur ISO	<b>lang mit Innenkühlung und Fase</b> long with through tool coolant and chamfers longue avec refroidissement interne et chanfrein	15°		<b>363</b>



# Übersicht VHM-Gewindefräser

Overview solid carbide thread milling cutter  
Aperçu fraise à fileter en carbure monobloc

Bezeichnung Description Désignation	Schneiden Flutes Tranchants	Fräser Type Type de fraise	Ausführung Design Modèle	Spiralwinkel Helix angle Angle d'hélice	Abb. Picture Fig.	Seite Page Page
<b>AFT - Gewindefräser UNC-Innengewinde / Thread milling cutter UNC-internal thread / fraise à fileter filetage intérieur UNC</b>						
AFT525.1-UNC...	3 - 5	<b>Gewindefräser UNC - Innengewinde</b> <i>Thread milling cutter UNC - internal thread</i> Fraise à fileter filetage intérieur UNC	<b>mittellang</b> <i>medium length</i> mi-longue	15°		<b>364</b>
AFT525.1-UNC...IK-F	3 - 5	<b>Gewindefräser UNC - Innengewinde</b> <i>Thread milling cutter UNC - internal thread</i> Fraise à fileter filetage intérieur UNC	<b>mittellang mit Innenkühlung und Fase</b> <i>medium length with through tool coolant and chamfers</i> mi-longue avec refroidissement interne et chanfrein	15°		<b>365</b>
AFT52534-UNC...	3	<b>Gewindefräser UNC - Innengewinde</b> <i>Thread milling cutter UNC - internal thread</i> Fraise à fileter filetage intérieur UNC	<b>mini</b> <i>mini</i> mini	15°		<b>366</b>
<b>AFT - Gewindefräser UNF-Innengewinde / Thread milling cutter UNF-internal thread / fraise à fileter filetage intérieur UNF</b>						
AFT525.1-UNF...	3 - 5	<b>Gewindefräser UNF - Innengewinde</b> <i>UNF - internal thread</i> Fraise à fileter filetage intérieur UNF	<b>mittellang</b> <i>medium length</i> mi-longue	15°		<b>367</b>
AFT525.1-UNF...IK-F	3 - 5	<b>Gewindefräser UNF - Innengewinde</b> <i>UNF - internal thread</i> Fraise à fileter filetage intérieur UNF	<b>mittellang mit Innenkühlung und Fase</b> <i>medium length with through tool coolant and chamfers</i> mi-longue avec refroidissement interne et chanfrein	15°		<b>368</b>
<b>AFT - Gewindefräser BSP(G)-Innengewinde / Thread milling cutter BSP(G)-internal thread / fraise à fileter filetage intérieur BSP(G)</b>						
AFT525.1-BSP...IK	3 - 5	<b>Gewindefräser BSP - Innengewinde</b> <i>BSP - internal thread</i> Fraise à fileter filetage intérieur BSP	<b>mittellang mit Innenkühlung</b> <i>medium length with through tool coolant</i> mi-longue avec refroidissement interne	15°		<b>369</b>
<b>AFT - Gewindefräser NPT-Innengewinde / Thread milling cutter NPT-internal thread / fraise à fileter filetage intérieur NPT</b>						
AFT525.1-NPT...IK-F	3 - 4	<b>Gewindefräser NPT - Innengewinde</b> <i>NPT - internal thread</i> Fraise à fileter filetage intérieur NPT	<b>kurz mit Innenkühlung und Fase</b> <i>short with through tool coolant and chamfers</i> courte avec refroidissement interne et chanfrein	15°		<b>370</b>

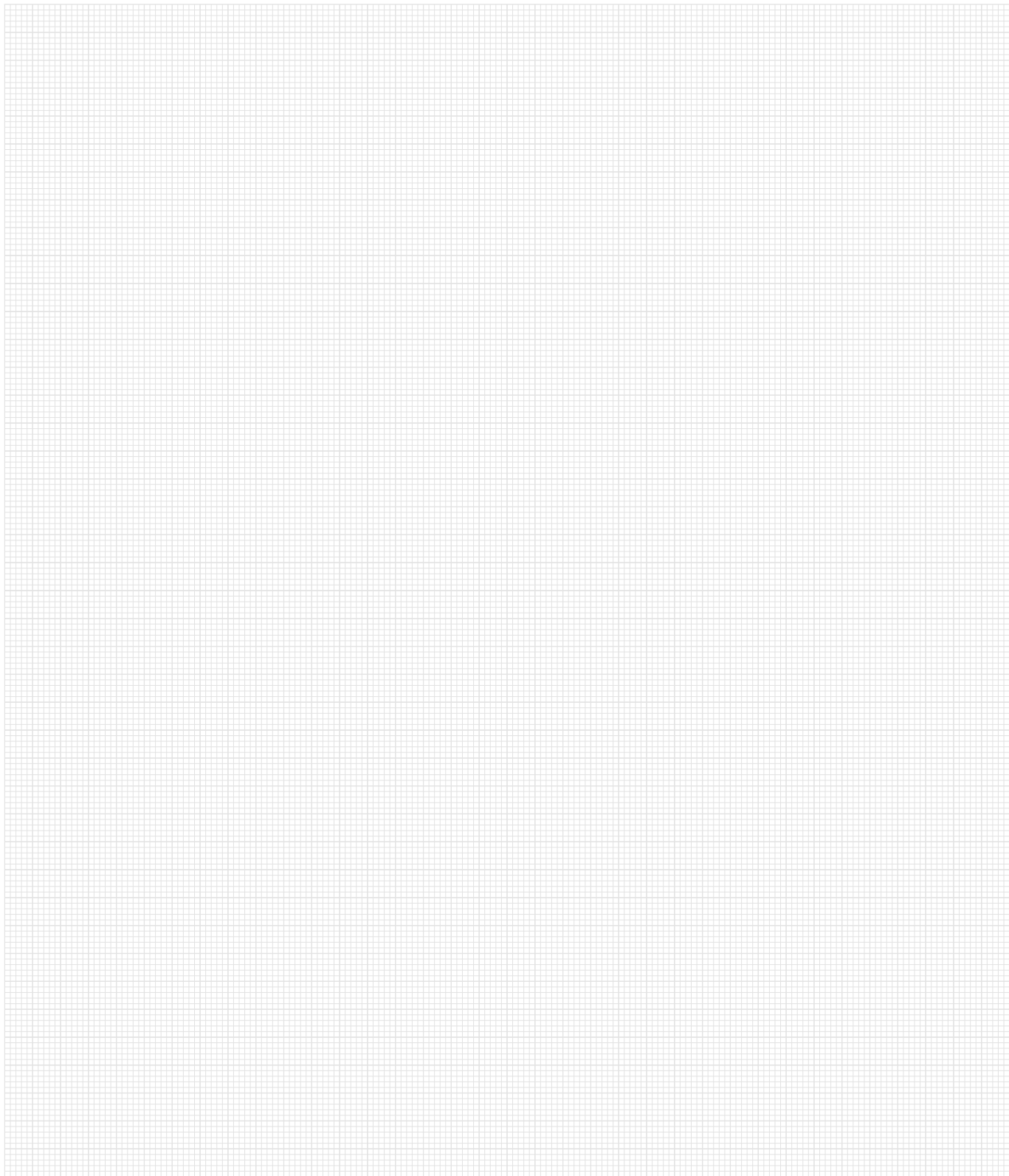

**Weitere Informationen finden Sie unter**  
*For more information see*  
**Pour plus d'informations**

**[www.arno.de](http://www.arno.de)**

# ARNO<sup>®</sup>

## WERKZEUGE

We have a passion for precision.

# AUSFÜHRUNG AFT

*Design AFT / Modèle AFT*

## **Rundum überzeugend: ARNO-Gewindefräser aus Vollhartmetall für die Bearbeitung von Stahl, Aluminium und NE-Metallen.**

*Solid carbide thread mills for  
steel, aluminium and non-ferrous materials.*

Tout simplement convaincant :

Fraises à fileter ARNO en carbure monobloc pour  
l'usinage des matériaux en acier, aluminium et des  
métaux non ferreux.

TiAlN beschichtete Gewindefräser aus  
Feinstkorn-Hartmetall bieten Ihnen eine  
optimale, gleichmäßige Gewindegüte  
sowie eine hohe Verschleißfestigkeit.



*Fine grain solid carbide cutters with  
TiAlN coating, some with through  
tool coolant and chamfering edge.*

Les fraises à fileter à revêtement TiAlN et en carbure micro-grains vous offrent une qualité de filets optimale et constante ainsi qu'une haute résistance à l'usure.

Thread milling cutter ISO-internal thread  
Fraise à fileter ISO - filetage intérieur

## AFT525.1-ISO-...

**3 - 5 Schneiden, 15° Rechtsspirale, mittellange Ausführung** / 3 - 5 flutes, 15 degree helix angle, mid-length design / 3 - 5 dents, hélice 15°, version mi-longue

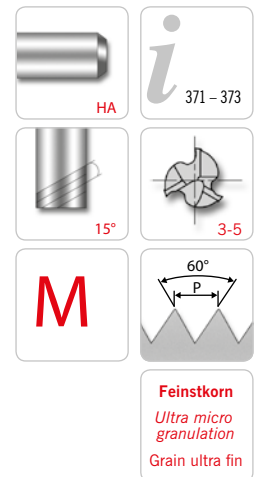
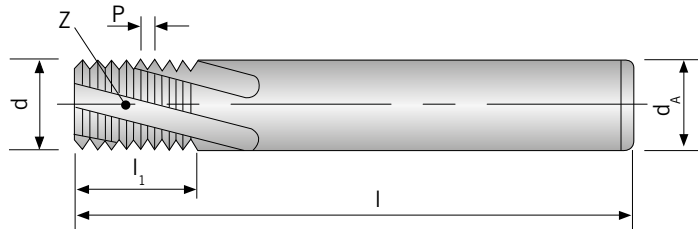

								PG 24
								beschichtet coated revêtu
Schaft DIN 6535HA Shank Tige	G Gewinde G Thread G Filetage	P Steigung P Pitch P Pas	d	d <sub>A</sub>	l <sub>1</sub>	l	z	TiAIN
AFT52531-ISO-M3X0.5	M3	0,50	2,2	6	5,00	57	3	●
AFT52531-ISO-M4X0.7	M4	0,70	2,9	6	7,00	57	3	●
AFT52531-ISO-M5X0.8	M5	0,80	3,8	6	8,00	57	3	●
AFT52531-ISO-M6X1.0	M6	1,00	4,5	6	13,00	57	3	●
AFT52531-ISO-M8X1.25	M8	1,25	6,0	6	17,50	65	3	●
AFT52541-ISO-M10X1.5	M10	1,50	7,5	8	21,00	72	4	●
AFT52541-ISO-M12X1.75	M12	1,75	9,5	10	26,25	80	4	●
AFT52541-ISO-M14X2.0	M14	2,00	10,0	10	30,00	83	4	●
AFT52541-ISO-M16X2.0	M16	2,00	12,0	12	34,00	92	4	●
AFT52551-ISO-M18X2.5	M18	2,50	14,0	14	37,50	92	5	●
AFT52551-ISO-M20X2.5	M20	2,50	16,0	16	42,50	105	5	●

P	●
M	○
K	○
N	●
S	○
H	

● **Hauptanwendung**  
Main application  
Application principale  
○ **Nebenanwendung**  
Secondary application  
Application secondaire

Thread milling cutter ISO-internal thread  
Fraise à fileter ISO - filetage intérieur

## AFT525.1-ISO-...IK

3 - 5 Schneiden, 15° Rechtsspirale, mittellange Ausführung / 3 - 5 flutes, 15 degree helix angle, mid-length design / 3 - 5 dents, hélice 15°, version mi-longue

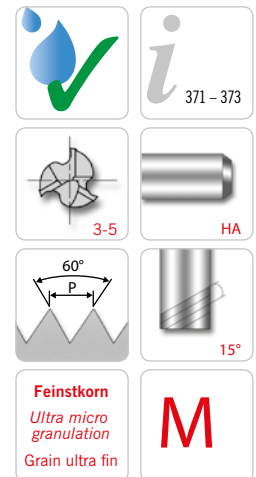
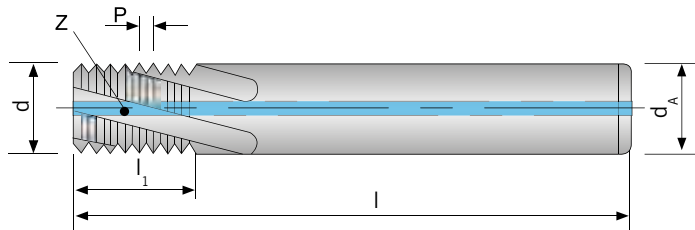

								PG 24
								beschichtet coated revêtu
Schaft DIN 6535HA Shank Tige	G Gewinde G Thread G Filetage	P Steigung P Pitch P Pas	d	d <sub>A</sub>	l <sub>1</sub>	l	z	TiAIN
AFT52531-ISO-M6X1.0IK	M6	1,00	4,5	6	13,00	57	3	●
AFT52531-ISO-M8X1.25IK	M8	1,25	6,0	6	17,50	65	3	●
AFT52541-ISO-M10X1.5IK	M10	1,50	7,5	8	21,00	72	4	●
AFT52541-ISO-M12X1.75IK	M12	1,75	9,5	10	26,25	80	4	●
AFT52541-ISO-M14X2.0IK	M14	2,00	10,0	10	30,00	83	4	●
AFT52541-ISO-M16X2.0IK	M16	2,00	12,0	12	34,00	92	4	●
AFT52551-ISO-M20X2.5IK	M20	2,50	16,0	16	42,50	105	5	●

P	●
M	○
K	○
N	●
S	○
H	

● Hauptanwendung  
Main application  
Application principale

○ Nebenanwendung  
Secondary application  
Application secondaire

Thread milling cutter ISO-internal thread  
Fraise à fileter ISO - filetage intérieur

## AFT525.1-ISO-...IK-F

3 - 4 Schneiden, 15° Rechtsspirale, mittellange Ausführung / 3 - 4 flutes, 15 degree helix angle, mid-length design / 3 - 4 dents, hélice 15°, version mi-longue

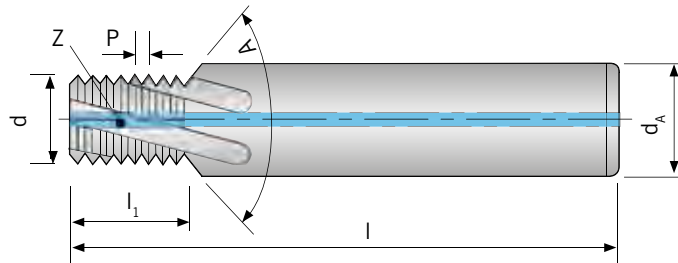

**Feinstkorn**  
Ultra micro granulation  
Grain ultra fin

										PG 24
										beschichtet coated revêtu
Schaft DIN 6535HA Shank Tige	G Gewinde G Thread G Filetage	P Steigung P Pitch P Pas	d	d <sub>A</sub>	l <sub>1</sub>	l	A	z		TiAIN
AFT52531-ISO-M6X1.0IK-F	M6	1,00	4,8	8	12,40	62	90,00°	3		●
AFT52531-ISO-M8X1.25IK-F	M8	1,25	6,5	10	16,80	74	90,00°	3		●
AFT52541-ISO-M10X1.5IK-F	M10	1,50	8,2	12	20,15	80	90,00°	4		●
AFT52541-ISO-M12X1.75IK-F	M12	1,75	9,9	14	25,25	90	90,00°	4		●
AFT52541-ISO-M14X2.0IK-F	M14	2,00	11,6	16	28,85	100	90,00°	4		●
AFT52541-ISO-M16X2.0IK-F	M16	2,00	13,6	18	32,85	102	90,00°	4		●

P	●
M	○
K	○
N	●
S	○
H	

● Hauptanwendung  
Main application  
Application principale

○ Nebenanwendung  
Secondary application  
Application secondaire

Thread milling cutter ISO-internal thread  
Fraise à fileter ISO - filetage intérieur

## AFT525.0-ISO-...

3 - 5 Schneiden, 15° Rechtsspirale, kurze Ausführung / 3 - 5 flutes, 15 degree helix angle, short design / 3 - 5 dents, hélice 15°, version courte

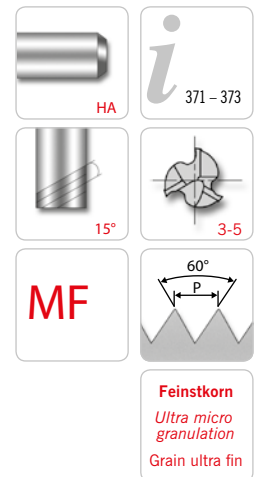
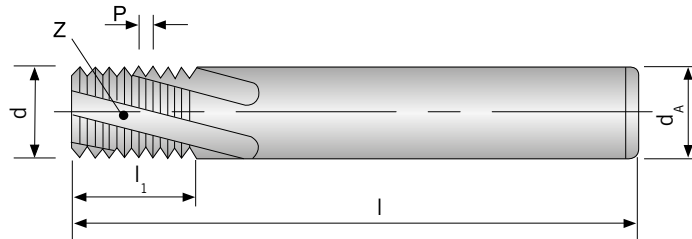

								PG 24
								beschichtet coated revêtu
Schaft DIN 6535HA Shank Tige	G Gewinde G Thread G Filetage	P Steigung P Pitch P Pas	d	d <sub>A</sub>	l <sub>1</sub>	l	z	TiAIN
AFT52530-ISO-M8X0.75	M8	0,75	6,0	6	12,75	57	3	●
AFT52530-ISO-M8X1.0	M8	1,00	6,0	6	13,00	57	3	●
AFT52540-ISO-M10X1.0	M10	1,00	8,0	8	16,00	63	4	●
AFT52540-ISO-M12X1.0	M12	1,00	9,5	10	19,00	72	4	●
AFT52540-ISO-M12X1.5	M12	1,50	9,5	10	19,50	72	4	●
AFT52540-ISO-M12X1.25	M12	1,25	9,5	10	18,75	72	4	●
AFT52540-ISO-M14X1.0	M14	1,00	10,0	10	22,00	83	4	●
AFT52540-ISO-M14X1.5	M14	1,50	10,0	10	22,50	83	4	●
AFT52540-ISO-M16X1.0	M16	1,00	12,0	12	25,00	83	4	●
AFT52540-ISO-M16X1.5	M16	1,50	12,0	12	25,50	83	4	●
AFT52550-ISO-M18X1.0	M18	1,00	14,0	14	28,00	92	5	●
AFT52550-ISO-M18X1.5	M18	1,50	14,0	14	28,50	92	5	●
AFT52550-ISO-M20X1.0	M20	1,00	16,0	16	31,00	92	5	●
AFT52550-ISO-M20X1.5	M20	1,50	16,0	16	31,50	92	5	●

P	●
M	○
K	○
N	●
S	○
H	

● Hauptanwendung  
Main application  
Application principale  
○ Nebenanwendung  
Secondary application  
Application secondaire

Thread milling cutter ISO-internal thread  
Fraise à fileter ISO - filetage intérieur

## AFT525.0-ISO-...IK

3 - 5 Schneiden, 15° Rechtsspirale, kurze Ausführung / 3 - 5 flutes, 15 degree helix angle, short design / 3 - 5 dents, hélice 15°, version courte

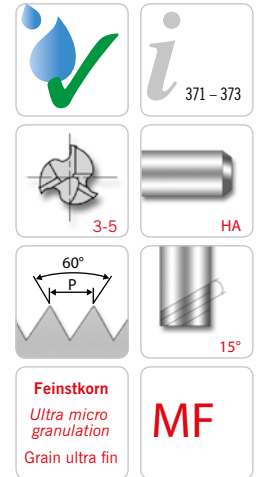
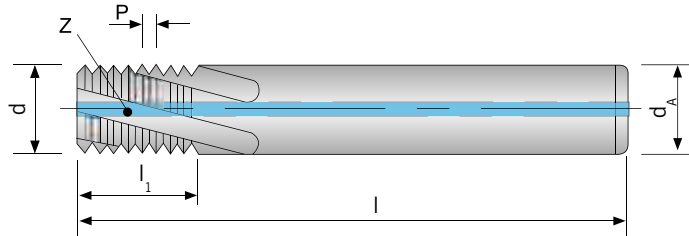

									PG 24
									beschichtet coated revêtu
Schaft DIN 6535HA Shank Tige	G Gewinde G Thread G Filetage	P Steigung P Pitch P Pas	d	d <sub>A</sub>	l <sub>1</sub>	l	z	TiAIN	
AFT52530-ISO-M8X0.75IK	M8	0,75	6,0	6	12,75	57	3	●	
AFT52530-ISO-M8X1.0IK	M8	1,00	6,0	6	13,00	57	3	●	
AFT52540-ISO-M10X1.0IK	M10	1,00	8,0	8	16,00	63	4	●	
AFT52540-ISO-M12X1.0IK	M12	1,00	9,5	10	19,00	72	4	●	
AFT52540-ISO-M12X1.5IK	M12	1,50	9,5	10	19,50	72	4	●	
AFT52540-ISO-M12X1.25IK	M12	1,25	9,5	10	18,75	72	4	●	
AFT52540-ISO-M14X1.0IK	M14	1,00	10,0	10	22,00	83	4	●	
AFT52540-ISO-M14X1.5IK	M14	1,50	10,0	10	22,50	83	4	●	
AFT52540-ISO-M16X1.0IK	M16	1,00	12,0	12	25,00	83	4	●	
AFT52540-ISO-M16X1.5IK	M16	1,50	12,0	12	25,50	83	4	●	
AFT52550-ISO-M18X1.0IK	M18	1,00	14,0	14	28,00	92	5	●	
AFT52550-ISO-M18X1.5IK	M18	1,50	14,0	14	28,50	92	5	●	
AFT52550-ISO-M20X1.0IK	M20	1,00	16,0	16	31,00	92	5	●	
AFT52550-ISO-M20X1.5IK	M20	1,50	16,0	16	31,50	92	5	●	

P	●
M	○
K	○
N	●
S	○
H	

● Hauptanwendung  
Main application  
Application principale  
○ Nebenanwendung  
Secondary application  
Application secondaire



Thread milling cutter ISO-internal thread  
Fraise à fileter ISO - filetage intérieur

## AFT525.0-ISO-...IK-F

3 - 5 Schneiden, 15° Rechtsspirale, kurze Ausführung / 3 - 5 flutes, 15 degree helix angle, short design / 3 - 5 dents, hélice 15°, version courte

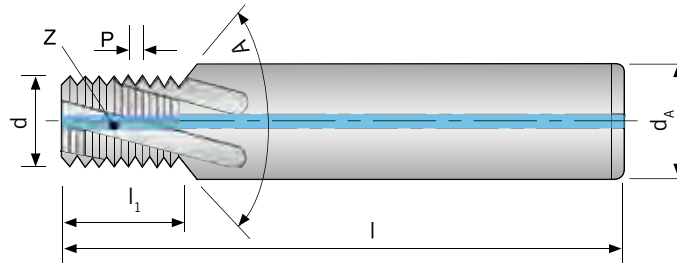

**Feinstkorn**  
Ultra micro granulation  
Grain ultra fin

									PG 24
									beschichtet coated revêtu
Schaft DIN 6535HA Shank Tige	G Gewinde G Thread G Filetage	P Steigung P Pitch P Pas	d	d <sub>A</sub>	l <sub>1</sub>	l	A	z	TiAIN
AFT52530-ISO-M8X1.0IK-F	M8	1,00	6,7	10	12,40	74	90,00°	3	●
AFT52540-ISO-M10X1.0IK-F	M10	1,00	8,7	12	15,40	80	90,00°	4	●
AFT52540-ISO-M10X1.25IK-F	M10	1,25	8,3	12	15,90	80	90,00°	4	●
AFT52540-ISO-M12X1.0IK-F	M12	1,00	10,7	14	18,40	90	90,00°	4	●
AFT52540-ISO-M12X1.5IK-F	M12	1,50	10,0	14	18,65	90	90,00°	4	●
AFT52540-ISO-M12X1.25IK-F	M12	1,25	10,3	14	18,30	80	90,00°	4	●
AFT52540-ISO-M14X1.5IK-F	M14	1,50	12,0	16	21,65	100	90,00°	4	●
AFT52550-ISO-M16X1.5IK-F	M16	1,50	14,0	18	24,65	102	90,00°	5	●

P	●
M	○
K	○
N	●
S	○
H	

● **Hauptanwendung**  
Main application  
Application principale

○ **Nebenanwendung**  
Secondary application  
Application secondaire

Thread milling cutter ISO-internal thread  
Fraise à fileter ISO - filetage intérieur

## AFT52534-ISO-...

**3 Schneiden, 15° Rechtsspirale, Mini Ausführung** / 3 flutes, 15 degree helix angle, mini design / 3 dents, hélice 15°, version mini

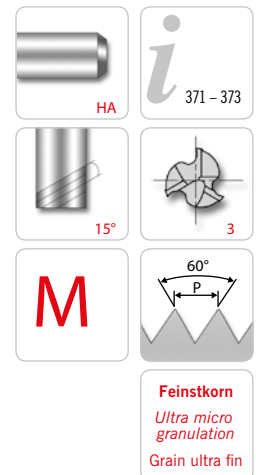
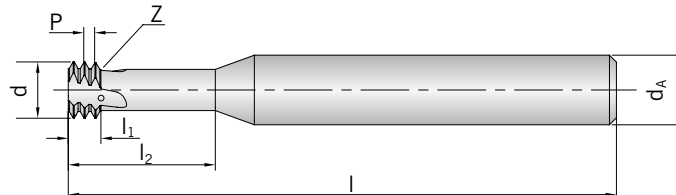

									PG 24
									beschichtet coated revêtu
Schaft DIN 6535HA Shank Tige	G Gewinde G Thread G Filetage	P Steigung P Pitch P Pas	d	d <sub>A</sub>	l <sub>1</sub>	l <sub>2</sub>	l	z	TiAIN
AFT52534-ISO-M1.6X0.35	M1,6	0,35	1,18	3	1,05	3,4	30	3	●
AFT52534-ISO-M2.2X0.45	M2,2	0,45	1,66	6	1,35	4,6	57	3	●
AFT52534-ISO-M2.5X0.45	M2,5	0,45	1,96	6	1,35	5,3	57	3	●
AFT52534-ISO-M2X0.4	M2	0,40	1,52	6	1,20	4,2	57	3	●
AFT52534-ISO-M3X0.5	M3	0,50	2,40	6	1,50	6,3	57	3	●
AFT52534-ISO-M4X0.7	M4	0,70	3,16	6	2,10	8,4	57	3	●
AFT52534-ISO-M5X0.8	M5	0,80	4,04	6	2,40	10,5	57	3	●
AFT52534-ISO-M6X1.0	M6	1,00	4,80	6	3,00	12,6	57	3	●
AFT52534-ISO-M8X1.25	M8	1,25	6,50	8	3,75	16,8	63	3	●
AFT52534-ISO-M10X1.5	M10	1,50	8,20	10	4,50	21,0	73	3	●
AFT52534-ISO-M12X1.75	M12	1,75	9,90	10	5,25	25,2	73	3	●

P	●
M	○
K	○
N	●
S	○
H	

● Hauptanwendung  
Main application  
Application principale

○ Nebenanwendung  
Secondary application  
Application secondaire

Drilling, countersinking and internal thread milling  
 Perçage, chanfreinage et fraisage de filets - filetage intérieur

## AFT52621-ISO-...IK-F

2 Schneiden, 15° Rechtsspirale, lange Ausführung / 2 flutes, 15 degree helix angle, long design / 2 dents, hélice 15° version longue

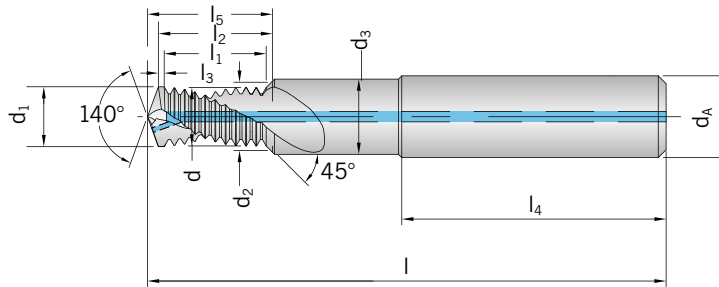
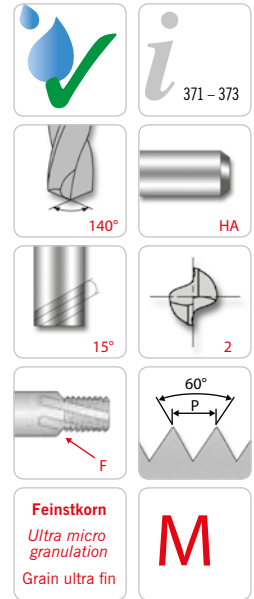

														PG 24
														beschichtet coated revêtu
Schaft DIN 6535HA Shank Tige	G Gewinde G Thread G Filetage	P Steigung P Pitch P Pas	d	d <sub>A</sub>	d <sub>1</sub>	d <sub>2</sub>	d <sub>3</sub>	l <sub>1</sub>	l <sub>2</sub>	l <sub>3</sub>	l <sub>4</sub>	l <sub>5</sub>	l	TiAIN
AFT52621-ISO-M6X1.0IK-F	M6	1,00	4,75	8	5,00	6,3	6,6	13,00	13,77	1,00	36	14,68	62	●
AFT52621-ISO-M8X1.25IK-F	M8	1,25	6,35	10	6,75	8,3	9,0	16,27	17,25	1,25	40	18,48	74	●
AFT52621-ISO-M10X1.5IK-F	M10	1,50	7,95	12	8,50	10,3	11,0	21,05	22,22	1,50	45	23,77	79	●
AFT52621-ISO-M12X1.75IK-F	M12	1,75	9,95	14	10,25	12,3	13,5	24,21	25,38	1,50	45	27,25	89	●
AFT52621-ISO-M14X2.0IK-F	M14	2,00	11,20	16	12,00	14,3	15,5	29,58	31,13	1,50	48	33,32	102	●

P	●
M	○
K	○
N	●
S	○
H	

● Hauptanwendung  
Main application  
Application principale

○ Nebenanwendung  
Secondary application  
Application secondaire

Thread milling cutter UNC-internal thread  
Fraise à fileter UNC - filetage intérieur

## AFT525.1-UNC-...

**3 - 5 Schneiden, 15° Rechtsspirale, mittellange Ausführung** / 3 - 5 flutes, 15 degree helix angle, mid-length design / 3 - 5 dents, hélice 15°, version mi-longue

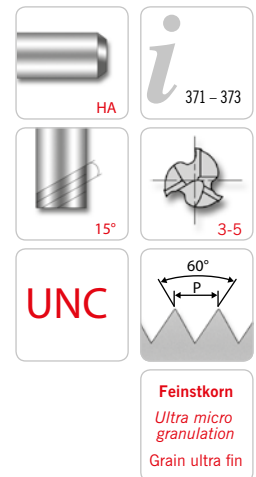
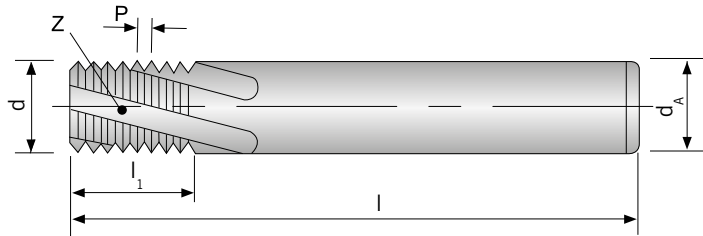

								PG 24
								beschichtet coated revêtu
Schaft DIN 6535HA Shank Tige	G Gewinde G Thread G Filetage	P Steigung P Pitch P Pas	d	d <sub>A</sub>	l <sub>1</sub>	l	z	TiAIN
AFT52531-UNC-1/4X20	1/4"	20	4,5	6	14,0	57	3	●
AFT52531-UNC-5/16X18	5/16"	18	5,8	6	16,9	65	3	●
AFT52541-UNC-1/2X13	1/2"	13	9,5	10	27,4	80	4	●
AFT52541-UNC-3/8X16	3/8"	16	7,0	8	20,6	72	4	●
AFT52541-UNC-5/8X11	5/8"	11	12,0	12	34,6	92	4	●
AFT52541-UNC-7/16X14	7/16"	14	8,0	8	23,6	72	4	●
AFT52541-UNC-9/16X12	9/16"	12	10,0	10	31,8	83	4	●
AFT52551-UNC-3/4X10	3/4"	10	14,0	14	40,6	104	5	●

P	●
M	○
K	○
N	●
S	○
H	

● **Hauptanwendung**  
Main application  
Application principale

○ **Nebenanwendung**  
Secondary application  
Application secondaire

Thread milling cutter UNC-internal thread  
Fraise à fileter UNC - filetage intérieur

## AFT525.1-UNC-...IK-F

3 - 5 Schneiden, 15° Rechtsspirale, mittellange Ausführung / 3 - 5 flutes, 15 degree helix angle, mid-length design / 3 - 5 dents, hélice 15°, version mi-longue

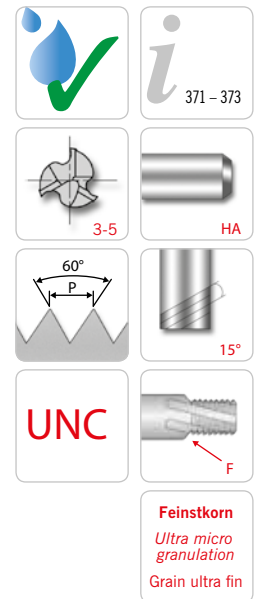
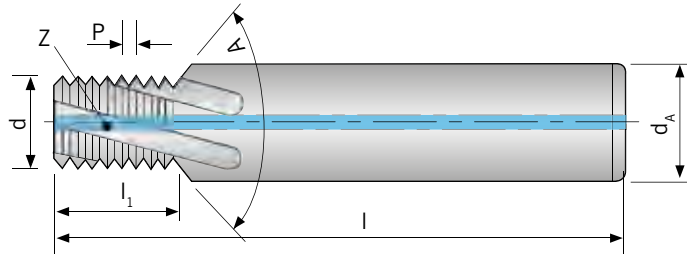

									PG 24
									beschichtet coated revêtu
Schaft DIN 6535HA Shank Tige	G Gewinde G Thread G Filetage	P Steigung P Pitch P Pas	d	d <sub>A</sub>	l <sub>1</sub>	l	A	z	TiAIN
AFT52531-UNC-1/4X20IK-F	1/4"	20	4,8	8	13,30	62	90,00°	3	●
AFT52531-UNC-5/16X18IK-F	5/16"	18	6,2	10	16,18	74	90,00°	3	●
AFT52541-UNC-1/2X13IK-F	1/2"	13	10,3	14	26,32	90	90,00°	4	●
AFT52541-UNC-3/8X16IK-F	3/8"	16	7,6	12	19,80	80	90,00°	4	●
AFT52541-UNC-5/8X11IK-F	5/8"	11	13,1	18	33,41	102	90,00°	4	●
AFT52541-UNC-7/16X14IK-F	7/16"	14	8,9	12	22,62	80	90,00°	4	●
AFT52541-UNC-9/16X12IK-F	9/16"	12	11,7	16	30,63	100	90,00°	4	●
AFT52551-UNC-3/4X10IK-F	3/4"	10	16,0	20	39,29	110	90,00°	5	●

P	●
M	○
K	○
N	●
S	○
H	

● Hauptanwendung  
Main application  
Application principale

○ Nebenanwendung  
Secondary application  
Application secondaire

Thread milling cutter UNC-internal thread  
Fraise à fileter UNC - filetage intérieur

## AFT52534-UNC-...

**3 Schneiden, 15° Rechtsspirale, Mini Ausführung** / 3 flutes, 15 degree helix angle, mini design / 3 dents, hélice 15°, version mini

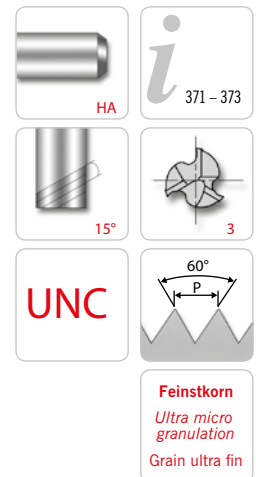
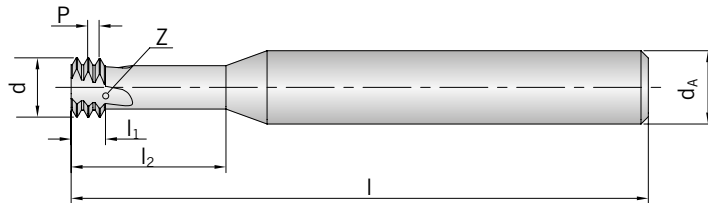

									PG 24
									beschichtet coated revêtu
Schaft DIN 6535HA Shank Tige	G Gewinde G Thread G Filetage	P Steigung P Pitch P Pas	d	d <sub>A</sub>	l <sub>1</sub>	l <sub>2</sub>	l	z	TiAIN
AFT52534-UNC-1/4X20	1/4"	20	4,83	6	3,81	13,3	57	3	●
AFT52534-UNC-1X64	#1	64	1,38	6	1,19	3,9	57	3	●
AFT52534-UNC-2X56	#2	56	1,64	6	1,36	4,6	57	3	●
AFT52534-UNC-3/8X16	3/8"	16	7,62	8	4,76	20,0	63	3	●
AFT52534-UNC-4X40	#4	40	2,08	6	1,91	6,0	57	3	●
AFT52534-UNC-5/16X18	5/16"	18	6,24	8	4,23	16,7	63	3	●
AFT52534-UNC-6X32	#6	32	2,55	6	2,38	7,4	57	3	●
AFT52534-UNC-7/16X14	7/16"	14	8,94	10	5,44	23,3	73	3	●
AFT52534-UNC-8X32	#8	32	3,21	6	2,38	8,7	57	3	●
AFT52534-UNC-10X24	#10	24	3,56	6	3,18	10,1	57	3	●
AFT52534-UNC-12X24	#12	24	4,22	6	3,18	11,5	57	3	●

P	●
M	○
K	○
N	●
S	○
H	

● Hauptanwendung  
Main application  
Application principale  
○ Nebenanwendung  
Secondary application  
Application secondaire

Thread milling cutter UNF-internal thread  
Fraise à fileter UNF - filetage intérieur

## AFT525.1-UNF-...

3 - 5 Schneiden, 15° Rechtsspirale, mittellange Ausführung / 3 - 5 flutes, 15 degree helix angle, mid-length design / 3 - 5 dents, hélice 15°, version mi-longue

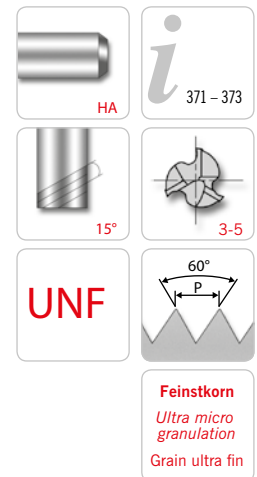
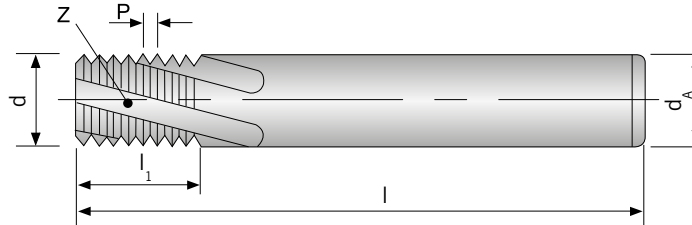

								PG 24
								beschichtet coated revêtu
Schaft DIN 6535HA Shank Tige	G Gewinde G Thread G Filetage	P Steigung P Pitch P Pas	d	d <sub>A</sub>	l <sub>1</sub>	l	z	TiAIN
AFT52531-UNF-1/4X28	1/4"	28	5	6	13,6	57	3	●
AFT52531-UNF-5/16X24	5/16"	24	6	6	16,9	65	3	●
AFT52541-UNF-1/2X20	1/2"	20	10	10	26,7	80	4	●
AFT52541-UNF-3/8X24	3/8"	24	8	8	20,1	72	4	●
AFT52541-UNF-5/8X18	5/8"	18	12	12	33,9	92	4	●
AFT52541-UNF-7/16X20	7/16"	20	8	8	24,1	72	4	●
AFT52541-UNF-9/16X18	9/16"	18	12	12	29,6	83	4	●
AFT52551-UNF-3/4X16	3/4"	16	14	14	39,7	104	5	●

P	●
M	○
K	○
N	●
S	○
H	

● Hauptanwendung  
Main application  
Application principale

○ Nebenanwendung  
Secondary application  
Application secondaire

Thread milling cutter UNF-internal thread  
Fraise à fileter UNF - filetage intérieur

## AFT525.1-UNF-...IK-F

3 - 5 Schneiden, 15° Rechtsspirale, mittellange Ausführung / 3 - 5 flutes, 15 degree helix angle, mid-length design / 3 - 5 dents, hélice 15°, version mi-longue

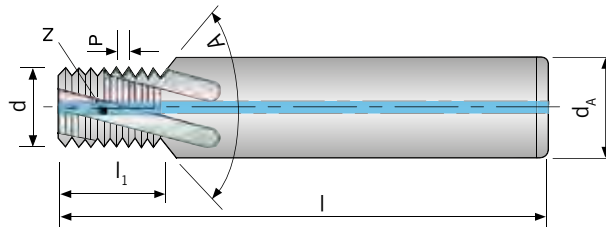

**UNF**

**Feinstkorn**  
Ultra micro granulation  
Grain ultra fin

									PG 24
									beschichtet coated revêtu
Schaft DIN 6535HA Shank Tige	G Gewinde G Thread G Filetage	P Steigung P Pitch P Pas	d	d <sub>A</sub>	l <sub>1</sub>	l	A	z	TiAIN
AFT52531-UNF-1/4X28IK-F	1/4"	28	5,1	8	13,21	62	90,00°	3	●
AFT52531-UNF-5/16X24IK-F	5/16"	24	6,5	10	16,37	74	90,00°	3	●
AFT52541-UNF-1/2X20IK-F	1/2"	20	11,0	14	26,00	90	90,00°	4	●
AFT52541-UNF-3/8X24IK-F	3/8"	24	8,1	12	19,54	80	90,00°	4	●
AFT52541-UNF-7/16X20IK-F	7/16"	20	9,4	12	22,19	80	90,00°	4	●
AFT52541-UNF-9/16X18IK-F	9/16"	18	12,4	16	28,88	100	90,00°	4	●
AFT52551-UNF-3/4X16IK-F	3/4"	16	17,0	20	38,86	110	90,00°	5	●
AFT52551-UNF-5/8X18IK-F	5/8"	18	14,0	18	33,12	102	90,00°	5	●

P	●
M	○
K	○
N	●
S	○
H	

● **Hauptanwendung**  
Main application  
Application principale

○ **Nebenanwendung**  
Secondary application  
Application secondaire



Thread milling cutter BSP(G)-internal thread  
Fraise à fileter BSP(G) - filetage intérieur

## AFT525.1-BSP-...IK

3 - 5 Schneiden, 15° Rechtsspirale, mittellange Ausführung / 3 - 5 flutes, 15 degree helix angle, mid-length design / 3 - 5 dents, hélice 15°, version mi-longue

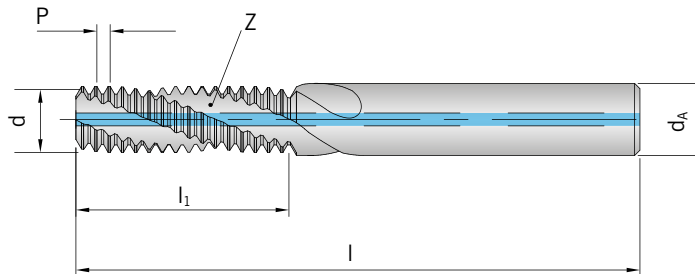

									PG 24
									beschichtet coated revêtu
Schaft DIN 6535HA Shank Tige	G Gewinde G Thread G Filetage	P Steigung P Pitch P Pas	d	d <sub>A</sub>	l <sub>1</sub>	l	z	TiAIN	
AFT52531-BSP-1/16X28IK	1/16"	28	5,9	6	16,3	65	3	●	
AFT52541-BSP-1/4X19IK	1/4"	19	9,9	10	26,7	80	4	●	
AFT52541-BSP-1/8X28IK	1/8"	28	7,9	8	20,0	70	4	●	
AFT52541-BSP-3/8X19IK	3/8"	19	13,9	14	33,4	92	4	●	
AFT52551-BSP-1/2X14IK	1/2"	14	15,9	16	43,5	104	5	●	
AFT52551-BSP-1X11IK	1"	11	19,9	20	34,6	100	5	●	
AFT52551-BSP-3/4X14IK	3/4"	14	17,9	18	34,5	100	5	●	

P	●
M	○
K	○
N	●
S	○
H	

● Hauptanwendung  
Main application  
Application principale  
○ Nebenanwendung  
Secondary application  
Application secondaire

Thread milling cutter NPT-internal thread  
Fraise à fileter NPT - filetage intérieur

## AFT525.1-NPT-...IK-F

3 - 4 Schneiden, 15° Rechtsspirale, kurze Ausführung / 3 - 4 flutes, 15 degree helix angle, short design / 3 - 4 dents, hélice 15°, version courte

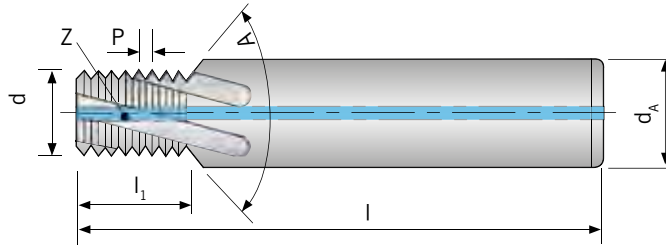

**Feinstkorn**  
Ultra micro granulation  
Grain ultra fin

PG 24									
beschichtet coated revêtu									
Schaft DIN 6535HA Shank Tige	G Gewinde G Thread G Filetage	P Steigung P Pitch P Pas	d	d <sub>A</sub>	l <sub>1</sub>	l	A	z	TiAIN
AFT52531-NPT-1/16X27IK-F	1/16"	27	5,90	10	8,9	64	90,00°	3	●
AFT52541-NPT-1/4X18IK-F	1/4"	18	10,05	16	13,4	81	90,00°	4	●
AFT52541-NPT-1/8X27IK-F	1/8"	27	7,80	12	8,9	70	90,00°	4	●
AFT52541-NPT-3/8X18IK-F	3/8"	18	13,45	18	13,4	81	90,00°	4	●

P	●
M	○
K	○
N	●
S	○
H	

● **Hauptanwendung**  
Main application  
Application principale

○ **Nebenanwendung**  
Secondary application  
Application secondaire

Werkstoff- gruppe	Gliederung der Werkstoffhauptgruppen und Kennbuchstaben		Brinell-Härte	Zugfestigkeit Rm (N/mm <sup>2</sup> )	Zerspanungsgruppe	Schnittgeschwindigkeit V <sub>c</sub> (m/min)		
						VHM TAIN	∅ 3 - 10 mm	∅ 12 - 20 mm
P	Unlegierter Stahl	C ≤ 0,25 % geglüht	125	428	P1	80 - 90 - 100	0,03 - 0,04 - 0,05	0,04 - 0,05 - 0,06
		C > 0,25 ... ≤ 0,55 % geglüht	190	639	P2	-	-	-
		C > 0,25 ... ≤ 0,55 % vergütet	210	708	P3	-	-	-
		C > 0,55 % geglüht	190	639	P4	-	-	-
		C > 0,55 % vergütet	300	1013	P5	-	-	-
		Automatenstahl (kurzspanend) geglüht	220	745	P6	80 - 90 - 100	0,03 - 0,04 - 0,05	0,04 - 0,05 - 0,06
	Niedrig legierter Stahl	geglüht	175	591	P7	-	-	-
		vergütet	300	1013	P8	40 - 50 - 60	0,01 - 0,02 - 0,03	0,02 - 0,03 - 0,04
		vergütet	380	1282	P9	-	-	-
		vergütet	430	1477	P10	-	-	-
	Hochlegierter Stahl und hochlegierter Werkzeugstahl	geglüht	200	675	P11	-	-	-
		gehärtet und angelassen	300	1013	P12	-	-	-
		gehärtet und angelassen	400	1361	P13	-	-	-
	Nichtrostender Stahl	ferritisch / martensitisch, geglüht	200	675	P14	-	-	-
		martensitisch, vergütet	330	1114	P15	80 - 100 - 120	0,04 - 0,05 - 0,06	0,06 - 0,07 - 0,08
M	Nichtrostender Stahl	austenitisch, abgeschreckt	200	675	M1	80 - 100 - 120	0,04 - 0,05 - 0,06	0,06 - 0,07 - 0,08
		austenitisch, ausscheidungsgehärtet (PH)	300	1013	M2	-	-	-
		austenitisch-ferritisch, Duplex	230	778	M3	-	-	-
K	Temperguss	ferritisch	200	675	K1	-	-	-
		perritisch	260	867	K2	-	-	-
	Grauguss	niedrige Festigkeit	180	602	K3	-	-	-
		hohe Festigkeit / austenitisch	245	825	K4	150 - 175 - 200	0,06 - 0,08 - 0,10	0,08 - 0,12 - 0,15
	Gusseisen mit Kugelgraphit	ferritisch	155	518	K5	100 - 125 - 150	0,04 - 0,05 - 0,06	0,06 - 0,07 - 0,08
		perritisch	265	885	K6	-	-	-
GGV (CGI)		200	675	K7	100 - 125 - 150	0,04 - 0,05 - 0,06	0,06 - 0,07 - 0,08	
N	Aluminium-Knetlegierungen	nicht aushärtbar	30	-	N1	-	-	-
		aushärtbar, ausgehärtet	100	343	N2	-	-	-
	Aluminium-Gusslegierungen	≤ 12 % Si, nicht aushärtbar	75	260	N3	-	-	-
		≤ 12 % Si, aushärtbar, ausgehärtet	90	314	N4	-	-	-
		> 12 % Si, nicht aushärtbar	130	447	N5	-	-	-
	Magnesiumlegierungen		70	250	N6	-	-	-
	Kupfer und Kupferlegierungen (Bronze / Messing)	unlegiert, Elektrolytkupfer	100	343	N7	-	-	-
		Messing, Bronze, Rotguss	90	314	N8	-	-	-
		Cu-Legierung, kurzspanend	110	382	N9	-	-	-
		hochfest, Ampco	300	1013	N10	-	-	-
Nichtmetallische Werkstoffe	Thermoplaste (ohne abrasive Füllstoffe)	-	-	N11	-	-	-	
	Duroplaste (ohne abrasive Füllstoffe)	-	-	N12	-	-	-	
	Kunststoff glasfaserverstärkt GFRP	-	-	N13	-	-	-	
	Kunststoff kohlefaserverstärkt CFRP	-	-	N14	-	-	-	
	Kunststoff aramidfaserverstärkt AFRP	-	-	N15	-	-	-	
	Graphit (technisch)	80 Shore	-	N16	-	-	-	
S	Warmfeste Legierungen	Fe-Basis geglüht	200	675	S1	-	-	-
		ausgehärtet	280	943	S2	-	-	-
		geglüht	250	839	S3	-	-	-
		Ni- oder Co-Basis ausgehärtet	350	1177	S4	-	-	-
		gegossen	320	1076	S5	-	-	-
	Titanlegierungen	Reintitan	200	675	S6	-	-	-
		α- und β-Legierungen, ausgehärtet	375	1262	S7	50 - 65 - 80	0,01 - 0,02 - 0,03	0,02 - 0,04 - 0,05
	β-Legierungen	410	1396	S8	50 - 65 - 80	0,01 - 0,02 - 0,03	0,02 - 0,04 - 0,05	
	Wolframlegierungen		300	1013	S9	-	-	-
	Molybdänlegierungen		300	1013	S10	-	-	-
H	Gehärteter Stahl	gehärtet und angelassen	50 HRC	-	H1	-	-	-
		gehärtet und angelassen	55 HRC	-	H2	-	-	-
		gehärtet und angelassen	60 HRC	-	H3	-	-	-
	Gehärtetes Gusseisen	gehärtet und angelassen	55 HRC	-	H4	-	-	-

Die Tabellenwerte sind Richtwerte. Es kann notwendig sein, die Werte den jeweiligen Bearbeitungsumständen anzupassen.

Material group	Structure of the material groups and identification letters		Brinell hardness HB	Tensile strength Rm (N/mm <sup>2</sup> )	Chipping group	Cutting speed V <sub>c</sub> (m/min)			
						VHM TAIN	∅ 3 - 10 mm	∅ 12 - 20 mm	
P	Unalloyed steel	C ≤ 0.25 % annealed	125	428	P1	80 - 90 - 100	0,03 - 0,04 - 0,05	0,04 - 0,05 - 0,06	
		C > 0.25 ... ≤ 0.55 % annealed	190	639	P2	-	-	-	
		C > 0.25 ... ≤ 0.55 % hardened and tempered	210	708	P3	-	-	-	
		C > 0.55 % annealed	190	639	P4	-	-	-	
		C > 0.55 % hardened and tempered	300	1013	P5	-	-	-	
		Machining steel (short-chipping) tempered	220	745	P6	80 - 90 - 100	0,03 - 0,04 - 0,05	0,04 - 0,05 - 0,06	
	Low alloyed steel	annealed	175	591	P7	-	-	-	
		hardened and tempered	300	1013	P8	40 - 50 - 60	0,01 - 0,02 - 0,03	0,02 - 0,03 - 0,04	
		hardened and tempered	380	1282	P9	-	-	-	
		hardened and tempered	430	1477	P10	-	-	-	
	High alloyed steel and high alloyed tool steel	annealed	200	675	P11	-	-	-	
		hardened	300	1013	P12	-	-	-	
		hardened	400	1361	P13	-	-	-	
	Stainless steel	ferritic / martensitic, annealed	200	675	P14	-	-	-	
		martensitic, hardened and tempered	330	1114	P15	80 - 100 - 120	0,04 - 0,05 - 0,06	0,06 - 0,07 - 0,08	
M	Stainless steel	austenitic, chilled	200	675	M1	80 - 100 - 120	0,04 - 0,05 - 0,06	0,06 - 0,07 - 0,08	
		austenitic, precipitation-hardened (PH)	300	1013	M2	-	-	-	
		austenitic-ferritic, Duplex	230	778	M3	-	-	-	
K	Malleable cast iron	ferritic	200	675	K1	-	-	-	
		pearlitic	260	867	K2	-	-	-	
	Cast iron	low tensile strength	180	602	K3	-	-	-	
		high tensile strength / austenitic	245	825	K4	150 - 175 - 200	0,06 - 0,08 - 0,10	0,08 - 0,12 - 0,15	
	Cast iron with nodular graphite	ferritic	155	518	K5	100 - 125 - 150	0,04 - 0,05 - 0,06	0,06 - 0,07 - 0,08	
		pearlitic	265	885	K6	-	-	-	
GGV (CGI)		200	675	K7	100 - 125 - 150	0,04 - 0,05 - 0,06	0,06 - 0,07 - 0,08		
N	Aluminium alloys long chipping	not heat treatable	30	-	N1	-	-	-	
		heat treatable, heat treated	100	343	N2	-	-	-	
	Casted aluminium alloys	≤ 12 % Si, not heat treatable	75	260	N3	-	-	-	
		≤ 12 % Si, aushärtbar, ausgehärtet	90	314	N4	-	-	-	
		> 12 % Si, not heat treatable	130	447	N5	-	-	-	
	Magnesium alloys		70	250	N6	-	-	-	
	Copper and copper alloys (Brass / Bronze)	Unalloyed, elektrolyte copper	100	343	N7	-	-	-	
		Brass, Bronze	90	314	N8	-	-	-	
		Cu-alloys, short-chipping	110	382	N9	-	-	-	
		High-tensile, Ampco	300	1013	N10	-	-	-	
Non-ferrous materials	Lead alloys (without abrasive filling material)	-	-	N11	-	-	-		
	Duroplastic (without abrasive filling material)	-	-	N12	-	-	-		
	Plastic glas fibre reinforced GFRP	-	-	N13	-	-	-		
	Plastic carbon fibre reinforced CFRP	-	-	N14	-	-	-		
	Plastic aramid fibre reinforced AFRP	-	-	N15	-	-	-		
	Graphite (tech.)	80 Shore	-	N16	-	-	-		
S	High temperature resistant alloys	Fe-Basis	annealed	200	675	S1	-	-	-
			heat treated	280	943	S2	-	-	-
		Ni- or Co-alloyed	annealed	250	839	S3	-	-	-
			heat treated	350	1177	S4	-	-	-
			casting	320	1076	S5	-	-	-
	Titanium alloys	Pure titan	200	675	S6	-	-	-	
		α- and β-alloys, heat treated	375	1262	S7	50 - 65 - 80	0,01 - 0,02 - 0,03	0,02 - 0,04 - 0,05	
	β-alloys	410	1396	S8	50 - 65 - 80	0,01 - 0,02 - 0,03	0,02 - 0,04 - 0,05		
	Wolfram alloys		300	1013	S9	-	-	-	
	Molybdän alloys		300	1013	S10	-	-	-	
H	Hardened steel	hardened	50 HRC	-	H1	-	-	-	
		hardened	55 HRC	-	H2	-	-	-	
		hardened	60 HRC	-	H3	-	-	-	
	Hardened cast iron	hardened	55 HRC	-	H4	-	-	-	

The recommended cutting data are only approximate values. It may be necessary to adjust them to each individual machining application.

ISO	Matériaux	Dureté Brinell	Résistance (N/mm <sup>2</sup> )	Groupe d'usinage	Vitesse de coupe Vc (m/min)			
					VHM TAIN	Ø 3 - 10 mm	Ø 12 - 20 mm	
P	Acier non allié	C ≤ 0,25 % recuit	125	428	P1	80 - 90 - 100	0,03 - 0,04 - 0,05	0,04 - 0,05 - 0,06
		C > 0,25 ... ≤ 0,55 % recuit	190	639	P2	-	-	-
		C > 0,25 ... ≤ 0,55 % traité	210	708	P3	-	-	-
		C > 0,55 % recuit	190	639	P4	-	-	-
		C > 0,55 % traité	300	1013	P5	-	-	-
	Acier faiblement allié	Aciers de décolletage (à copeaux courts) recuit	220	745	P6	80 - 90 - 100	0,03 - 0,04 - 0,05	0,04 - 0,05 - 0,06
		recuit	175	591	P7	-	-	-
		traité	300	1013	P8	40 - 50 - 60	0,01 - 0,02 - 0,03	0,02 - 0,03 - 0,04
		traité	380	1282	P9	-	-	-
		traité	430	1477	P10	-	-	-
Acier allié et acier outil allié	recuit	200	675	P11	-	-	-	
	trempé et revenu	300	1013	P12	-	-	-	
	trempé et revenu	400	1361	P13	-	-	-	
Acier inox	ferritique, martensitique, recuit	200	675	P14	-	-	-	
	martensitique, traité	330	1114	P15	80 - 100 - 120	0,04 - 0,05 - 0,06	0,06 - 0,07 - 0,08	
M	Acier inox	austénitique	200	675	M1	80 - 100 - 120	0,04 - 0,05 - 0,06	0,06 - 0,07 - 0,08
		austénitique	300	1013	M2	-	-	-
		austénitique-ferritique, Duplex	230	778	M3	-	-	-
K	Fonte malléable	ferritique	200	675	K1	-	-	-
		perlitique	260	867	K2	-	-	-
	Fonte grise	faible résistance	180	602	K3	-	-	-
		haute résistance / austénitique	245	825	K4	150 - 175 - 200	0,06 - 0,08 - 0,10	0,08 - 0,12 - 0,15
	Fonte à Graphite sphéroïdale	ferritique	155	518	K5	100 - 125 - 150	0,04 - 0,05 - 0,06	0,06 - 0,07 - 0,08
		perlitique	265	885	K6	-	-	-
GGV (CGI)		200	675	K7	100 - 125 - 150	0,04 - 0,05 - 0,06	0,06 - 0,07 - 0,08	
N	Alliages de fonderie d'aluminium	ne pouvant pas subir un durcissement	30	-	N1	-	-	-
		pouvant subir un durcissement, durci	100	343	N2	-	-	-
	Alliage de fonte d'aluminium	≤ 12 % Si, ne pouvant pas subir de durcissement	75	260	N3	-	-	-
		≤ 12 % Si, pouvant subir un durcissement, durci	90	314	N4	-	-	-
		> 12 % Si, ne pouvant pas subir de durcissement	130	447	N5	-	-	-
Alliage de Magnésium		70	250	N6	-	-	-	
Cuivre et alliage de cuivre (bronze / laiton)	non allié, cuivre électrolytique	100	343	N7	-	-	-	
	Laiton, bronze, fonte rouge	90	314	N8	-	-	-	
	Alliage de cuivre à copeaux courts	110	382	N9	-	-	-	
	forte résistance, Ampco	300	1013	N10	-	-	-	
Matériaux non métalliques	Thermoplaste (sans agents de charge abrasives)	-	-	N11	-	-	-	
	Duroplaste (sans agents de charge abrasives)	-	-	N12	-	-	-	
	Matière plastique renforcée de fibres de verre GFRP	-	-	N13	-	-	-	
	Matière plastique renforcé composite CFRP	-	-	N14	-	-	-	
	Plastique renforcé fibre aramide AFRP	-	-	N15	-	-	-	
	Graphite	80 Shore	-	N16	-	-	-	
S	Alliages réfractaires	à base de Fe recuit	200	675	S1	-	-	-
		durci	280	943	S2	-	-	-
		recuit	250	839	S3	-	-	-
		à base Ni ou Co durci	350	1177	S4	-	-	-
		jeter	320	1076	S5	-	-	-
	Alliage de titane	Titane pur	200	675	S6	-	-	-
		Alliages Alpha + Beta, trempé	375	1262	S7	50 - 65 - 80	0,01 - 0,02 - 0,03	0,02 - 0,04 - 0,05
		Alliages Beta	410	1396	S8	50 - 65 - 80	0,01 - 0,02 - 0,03	0,02 - 0,04 - 0,05
	Alliage de tungstène		300	1013	S9	-	-	-
	Alliage de molybdène		300	1013	S10	-	-	-
H	Acier trempé	trempé et revenu	50 HRC	-	H1	-	-	-
		trempé et revenu	55 HRC	-	H2	-	-	-
		trempé et revenu	60 HRC	-	H3	-	-	-
	Fonte durci	trempé et revenu	55 HRC	-	H4	-	-	-

Les valeurs du tableau sont indicatives. Il peut être nécessaire de les adapter aux conditions d'usinage respectives.

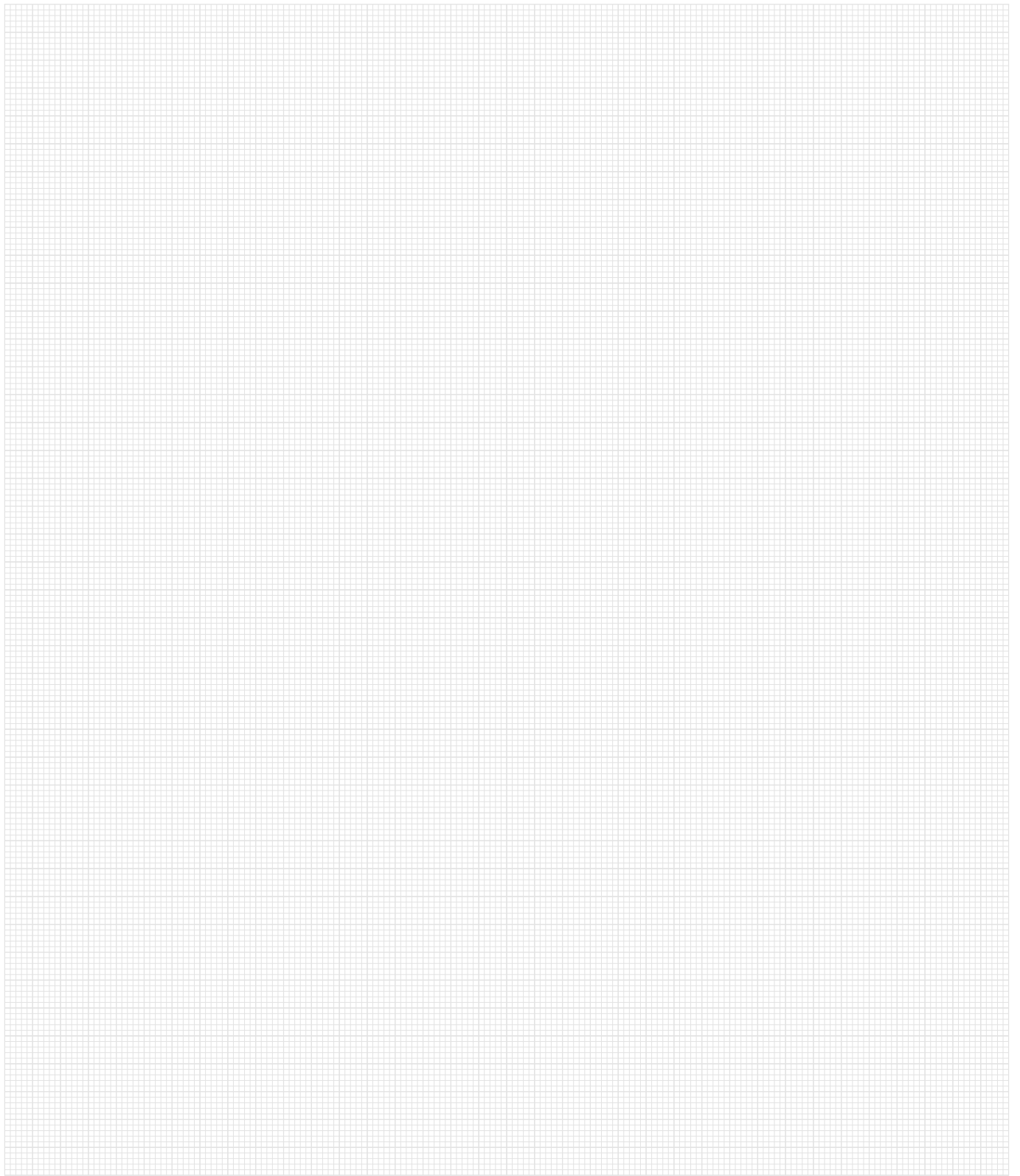

**Weitere Informationen finden Sie unter**  
*For more information see*  
**Pour plus d'informations**

**[www.arno.de](http://www.arno.de)**

# ARNO<sup>®</sup>

## WERKZEUGE

We have a passion for precision.

### VHM- UND PM-HSS-NC-ENTGRATER

*PM and HSS deburring cutters*  
Outil à chanfreiner en carbure  
monobloc et en PM-HSS

#### Ausführung

- AE - 4 Schneiden, 60°
- 4 Schneiden, 90°
- 4 Schneiden, 120°

#### Design

- AE - 4 flutes, 60°
- 4 flutes, 90°
- 4 flutes, 120°

#### Modèle

- AE - 4 dents, 60°
- 4 dents, 90°
- 4 dents, 120°



# Übersicht VHM- und PM-HSS-NC-Entgrater

Overview PM and HSS deburring cutters

Aperçu des fraises HSS formées par métallurgie des poudres

Bezeichnung Description Désignation	Schneiden Flutes Tranchants	Fräserstyp Type Type de fraise	Ausführung Design Modèle	Spiralwinkel Helix angle Angle d'hélice	Abb. Picture Fig.	Seite Page Page
<b>AE - VHM NC-Entgrater / Solid carbide deburring cutter / Ébavureur en carbure monobloc NC</b>						
AE63041-...	4	<b>VHM NC-Entgrater</b> Solid carbide deburring cutter Ébavureur en carbure monobloc NC	kurz short	60°		<b>378</b>
AE63141-...	4	<b>VHM NC-Entgrater</b> Solid carbide deburring cutter Ébavureur en carbure monobloc NC	kurz short	90°		<b>380</b>
AE63241-...	4	<b>VHM NC-Entgrater</b> Solid carbide deburring cutter Ébavureur en carbure monobloc NC	kurz short	120°		<b>382</b>
<b>AE - PM-HSS NC-Entgrater / Powder metal deburring cutter / ébavureur PM-HSS NC</b>						
AE63041-...-PM	4	<b>PM-HSS NC-Entgrater</b> Powder metal deburring cutter Ébavureur PM-HSS NC	kurz short	60°		<b>379</b>
AE63141-...-PM	4	<b>PM-HSS NC-Entgrater</b> Powder metal deburring cutter Ébavureur PM-HSS NC	kurz short	90°		<b>381</b>
AE63241-...-PM	4	<b>PM-HSS NC-Entgrater</b> Powder metal deburring cutter Ébavureur PM-HSS NC	kurz short	120°		<b>383</b>



# ARNO<sup>®</sup>

## WERKZEUGE

We have a passion for precision.

# AUSFÜHRUNG AE

*Design AE / Modèle AE*

## **Schneller als die Konkurrenz.**

*Coated for speed.*

*Le plus rapide.*

**Dank der TiAlN Beschichtung überzeugt der ARNO<sup>®</sup> Vollhartmetall NC-Entgrater durch eine um 50 % höhere Schnittgeschwindigkeit als ein unbeschichteter Entgrater. Er ist optimal für das Anfasen, Entgraten und Konturbearbeiten nahezu aller gängigen Werkstoffe geeignet. Auch MMS oder Trockenbearbeitung ist möglich.**



*Thanks to the TiAlN coating this NC-drill can be up to 50 % faster than the equivalent uncoated version. Suitable for nearly all materials. The tools can be used with micro lubrication coolant or run dry.*

Grâce à son revêtement TiAlN, l'outil à chanfreiner ARNO<sup>®</sup> en carbure monobloc NC offre une vitesse de coupe 50 % supérieure à celle d'un ébavureur non revêtu. Il convient parfaitement au chanfreinage, à l'ébavurage et à l'usinage des contours des pièces faites à partir de presque tous les matériaux courants. La micro-pulvérisation ou l'usinage à sec sont également possibles.

Solid carbide deburring cutter  
Ébavureur NC-carbure monobloc

## AE63041-...

4 Schneiden, 60° / 4 flutes, 60° / 4 dents, 60°

h6  
450 - 488  
60°  
4  
Feinstkorn  
Ultra micro granulation  
Grain ultra fin

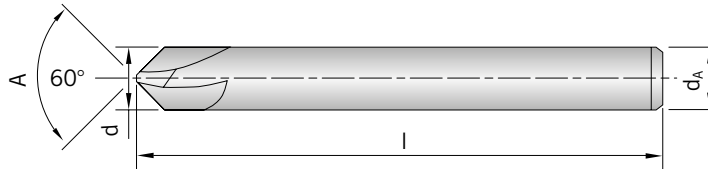

						PG 24
						beschichtet coated revêtu
Schaft Shank Tige	d	d <sub>A</sub>	l	A	TiAlN	
AE63041-040	4	4	54	60°	●	
AE63041-060	6	6	54	60°	●	
AE63041-080	8	8	58	60°	●	
AE63041-100	10	10	66	60°	●	
AE63041-120	12	12	73	60°	●	

P	●
M	●
K	●
N	●
S	●
H	●

● Hauptanwendung  
Main application  
Application principale

○ Nebenanwendung  
Secondary application  
Application secondaire

Powder metal deburring cutter  
Ébavureur-PM-HSS NC

## AE63041-....-PM

4 Schneiden, 60° / 4 flutes, 60° / 4 dents, 60°

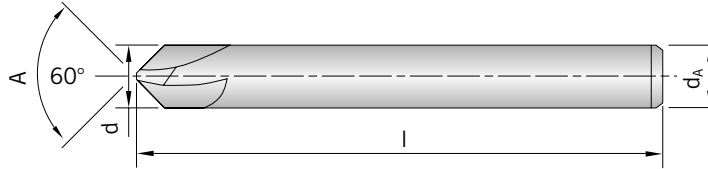
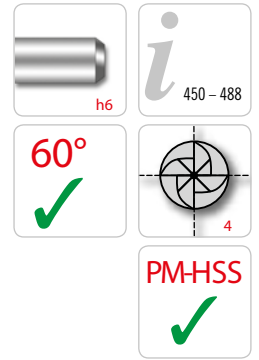

						PG 24
						beschichtet coated revêtu
Schaft Shank Tige	d	d <sub>A</sub>	l	A	TiAIN	
AE63041-040-PM	4	4	54	60°	●	
AE63041-060-PM	6	6	54	60°	●	
AE63041-080-PM	8	8	58	60°	●	
AE63041-100-PM	10	10	66	60°	●	
AE63041-120-PM	12	12	73	60°	●	

P	●
M	●
K	●
N	●
S	●
H	●

● Hauptanwendung  
Main application  
Application principale

○ Nebenanwendung  
Secondary application  
Application secondaire

Solid carbide deburring cutter  
Ébavureur NC-carbure monobloc

## AE63141-...

4 Schneiden, 90° / 4 flutes, 90°

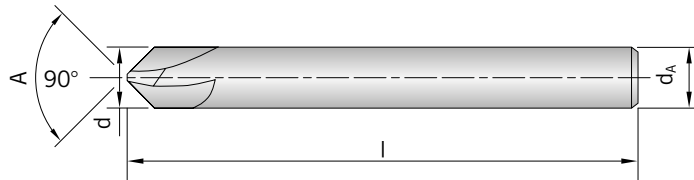
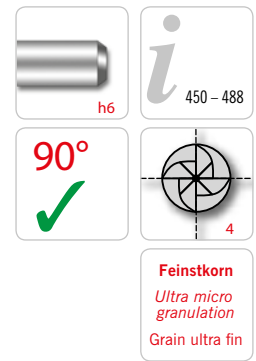

						PG 24
						beschichtet coated revêtu
Schaft Shank Tige	d	d <sub>A</sub>	l	A	TiAIN	
AE63141-040	4	4	54	90°	●	
AE63141-060	6	6	54	90°	●	
AE63141-080	8	8	58	90°	●	
AE63141-100	10	10	66	90°	●	
AE63141-120	12	12	73	90°	●	

P	●
M	●
K	●
N	●
S	●
H	●

● **Hauptanwendung**  
Main application  
Application principale

○ **Nebenanwendung**  
Secondary application  
Application secondaire

Powder metal deburring cutter  
Ébavureur-PM-HSS NC

## AE63141-...-PM

4 Schneiden, 90° / 4 flutes, 90°

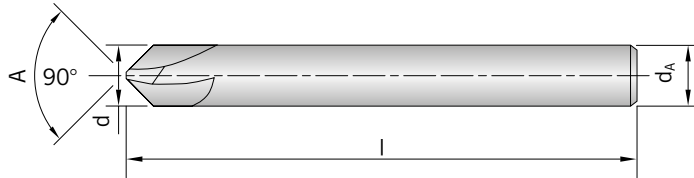
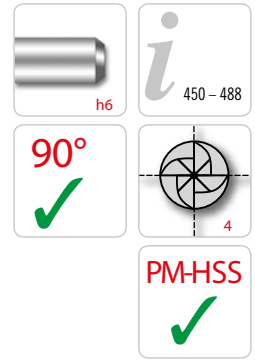

						PG 24
						beschichtet coated revêtu
Schaft Shank Tige	d	d <sub>A</sub>	l	A	TiAIN	
AE63141-040-PM	4	4	54	90°	●	
AE63141-060-PM	6	6	54	90°	●	
AE63141-080-PM	8	8	58	90°	●	
AE63141-100-PM	10	10	66	90°	●	
AE63141-120-PM	12	12	73	90°	●	

P	●
M	●
K	●
N	●
S	●
H	●

● Hauptanwendung  
Main application  
Application principale

○ Nebenanwendung  
Secondary application  
Application secondaire

Solid carbide deburring cutter  
Ébavureur NC-carbure monobloc

## AE63241-...

4 Schneiden, 120° / 4 flutes, 120° / 4 dents, 120°

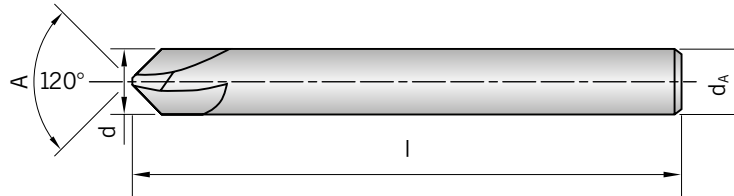
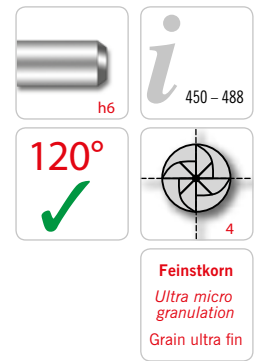

						PG 24
						beschichtet coated revêtu
Schaft Shank Tige	d	d <sub>A</sub>	l	A	TiAIN	
AE63241-040	4	4	54	120°	●	
AE63241-060	6	6	54	120°	●	
AE63241-080	8	8	58	120°	●	
AE63241-100	10	10	66	120°	●	
AE63241-120	12	12	73	120°	●	

P	●
M	●
K	●
N	●
S	●
H	●

● Hauptanwendung  
Main application  
Application principale

○ Nebenanwendung  
Secondary application  
Application secondaire

Powder metal deburring cutter  
Ébavureur-PM-HSS NC

## AE63241-....-PM

4 Schneiden, 120° / 4 flutes, 120° / 4 dents, 120°

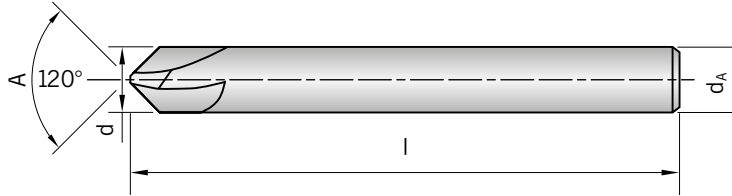
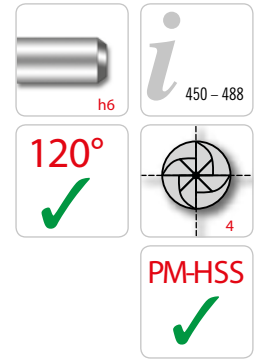

						PG 24
						beschichtet coated revêtu
Schaft Shank Tige	d	d <sub>A</sub>	l	A	TiAIN	
AE63241-040-PM	4	4	54	120°	●	
AE63241-060-PM	6	6	54	120°	●	
AE63241-080-PM	8	8	58	120°	●	
AE63241-100-PM	10	10	66	120°	●	
AE63241-120-PM	12	12	73	120°	●	

P	●
M	●
K	●
N	●
S	●
H	●

● Hauptanwendung  
Main application  
Application principale

○ Nebenanwendung  
Secondary application  
Application secondaire

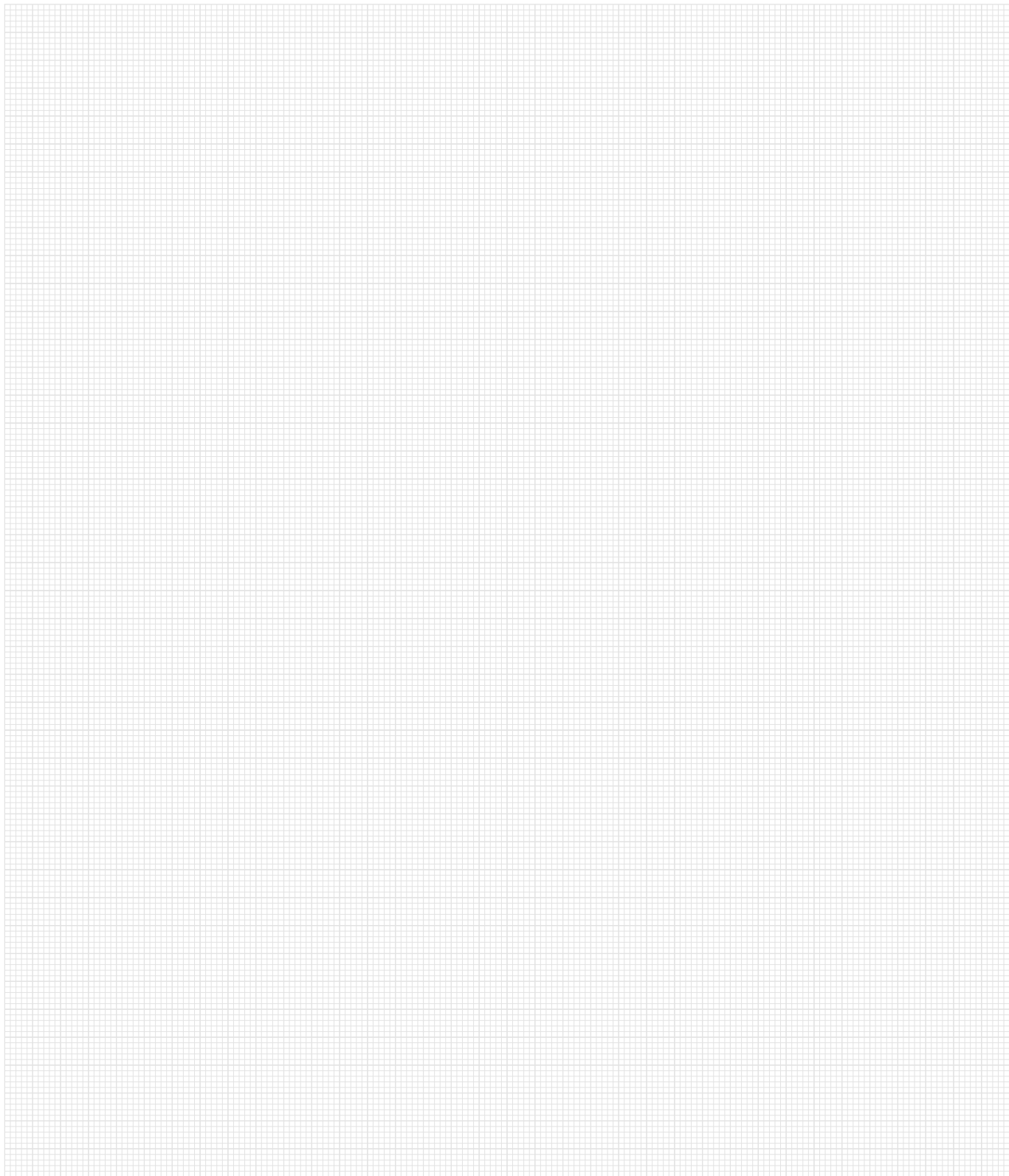

**Weitere Informationen finden Sie unter**  
*For more information see*  
**Pour plus d'informations**

**[www.arno.de](http://www.arno.de)**



# ARNO®

## WERKZEUGE

We have a passion for precision.

## VHM- UND PM-HSS-SPIRALBOHRER

*Solid carbide and PM-HSS drills*

Forets hélicoïdaux en carbure monobloc et PM-HSS

### Ausführung

- SP - 3 x D
- 3 x D für Aluminium
- 3 x D für rostfreie Stähle
- 3 x D PM-HSS Spiralbohrer
- 3 x D 3-schneidig
- 5 x D
- 5 x D für Aluminium
- 5 x D für rostfreie Stähle
- 5 x D 3-schneidig
- 5 x D für gehärtete Stähle
- 7 x D
- 7 x D PM-HSS Spiralbohrer
- 8 x D
- 8 x D für Aluminium
- 8 x D für rostfreie Stähle
- 10 x D
- 15 x D
- 20 x D
- 25 x D
- 30 x D
- NC-Anbohrer, 4 Schneiden, 90°, 120° und 135°
- Zentrierbohrer

### Design

- SP - 3 x D
- 3 x D for aluminium
- 3 x D for stainless steel
- 3 x D powder metal drill
- 3 x D 3 flutes
- 5 x D
- 5 x D for aluminium
- 5 x D for stainless steel
- 5 x D 3 flutes
- 5 x D for hardened steel
- 7 x D
- 7 x D powder metal drill
- 8 x D
- 8 x D for aluminium
- 8 x D for stainless steel
- 10 x D
- 15 x D
- 20 x D
- 25 x D
- 30 x D
- NC spot drills, 4 flutes, 90°, 120° and 135°
- Centre drills

### Modèle

- SP - 3 x D
- 3 x D pour aluminium
- 3 x D pour aciers inoxydables
- 3 x D PM-HSS
- 3 x D 3 lèvres
- 5 x D
- 5 x D pour aluminium
- 5 x D pour aciers inoxydables
- 5 x D 3 lèvres
- 5 x D pour aciers trempés
- 7 x D
- 7 x D PM-HSS
- 8 x D
- 8 x D pour aluminium
- 8 x D pour aciers inoxydables
- 10 x D
- 15 x D
- 20 x D
- 25 x D
- 30 x D
- foret à pointer NC, 4 dents, 90°, 120° et 135°
- foret de centrage



# Übersicht VHM- und PM-HSS-Spiralbohrer

Overview of solid carbide drills and powder metal drills  
Aperçu foret hélicoïdal en carbure monobloc et PM-HSS

Ausführung Design Modèle	Bohrertyp Type Type de foret	Innenkühlung Through tool coolant Refroidissement interne	Durchmesser Diameter Diamètre [mm]	Abb. Picture Fig.	Seite Page Page
<b>3 x D</b>					
<b>3 x D</b>	<b>Vollhartmetall-Spiralbohrer</b> <i>Solid carbide drill</i> Foret hélicoïdal en carbure monobloc	X	1,0 - 10,0		<b>390</b>
<b>3 x D</b>	<b>Vollhartmetall-Spiralbohrer</b> <i>Solid carbide drill</i> Foret hélicoïdal en carbure monobloc	X	1,0 - 20,0		<b>392</b>
<b>3 x D</b>	<b>Vollhartmetall-Spiralbohrer</b> <i>Solid carbide drill</i> Foret hélicoïdal en carbure monobloc	✓	3,0 - 20,0		<b>395</b>
<b>3 x D</b>	<b>Vollhartmetall-Spiralbohrer für Aluminium – diamant beschichtet</b> <i>Solid carbide drill for aluminium – diamond coated</i> Foret hélicoïdal en carbure monobloc <i>pour aluminium</i> avec revêtement diamant	✓	3,0 - 20,0		<b>398</b>
<b>3 x D</b>	<b>Vollhartmetall-Spiralbohrer für rostfreie Stähle</b> <i>Solid carbide drill for stainless steel</i> Foret hélicoïdal en carbure monobloc <i>pour aciers inoxydables</i>	✓	3,0 - 20,0		<b>400</b>
<b>3 x D</b>	<b>PM-HSS-Spiralbohrer</b> <i>Powder metal drill</i> Foret hélicoïdal PM-HSS	X	1,0 - 13,3		<b>403</b>
<b>3 x D</b> <b>NEU/NEW NOUVEAU</b>	<b>Vollhartmetall-Spiralbohrer, 3-schneidig</b> <i>Solid carbide drill, 3 flutes</i> Foret hélicoïdal en carbure monobloc, 3 lèbres	✓	1,0 - 13,3		<b>405</b>
<b>5 x D</b>					
<b>5 x D</b>	<b>Vollhartmetall-Spiralbohrer</b> <i>Solid carbide drill</i> Foret hélicoïdal en carbure monobloc	X	1,0 - 20,0		<b>408</b>
<b>5 x D</b>	<b>Vollhartmetall-Spiralbohrer</b> <i>Solid carbide drill</i> Foret hélicoïdal en carbure monobloc	✓	1,0 - 20,0		<b>411</b>
<b>5 x D</b>	<b>Vollhartmetall-Spiralbohrer für Aluminium – diamant beschichtet</b> <i>Solid carbide drill for aluminium – diamond coated</i> Foret hélicoïdal en carbure monobloc <i>pour aluminium</i> avec revêtement diamant	✓	3,0 - 20,0		<b>414</b>
<b>5 x D</b>	<b>Vollhartmetall-Spiralbohrer für rostfreie Stähle</b> <i>Solid carbide drill for stainless steel</i> Foret hélicoïdal en carbure monobloc <i>pour aciers inoxydables</i>	✓	1,5 - 20,0		<b>416</b>

# Übersicht VHM- und PM-HSS-Spiralbohrer











Overview of solid carbide drills and powder metal drills  
Aperçu foret hélicoïdal en carbure monobloc et PM-HSS

Ausführung Design Modèle	Bohrertyp Type Type de foret	Innenkühlung Through tool coolant Refroidissement interne	Durchmesser Diameter Diamètre [mm]	Abb. Picture Fig.	Seite Page Page
<b>5 x D</b> <b>NEU/NEW NOUVEAU</b>	<b>Vollhartmetall-Spiralbohrer, 3-schneidig</b> <i>Solid carbide drill, 3 flutes</i> Foret hélicoïdal en carbure monobloc, 3 lèvres	✓	5,0 - 20,0		<b>419</b>
<b>5 x D</b>	<b>Vollhartmetall-Spiralbohrer für gehärtete Stähle</b> <i>Solid carbide drill for hardened steel</i> Foret hélicoïdal en carbure monobloc pour aciers trempés	✗	3,0 - 14,0		<b>422</b>
<b>7 x D</b>					
<b>7 x D</b>	<b>Vollhartmetall-Spiralbohrer</b> <i>Solid carbide drill</i> Foret hélicoïdal en carbure monobloc	✗	1,0 - 10,0		<b>424</b>
<b>7 x D</b>	<b>Vollhartmetall-Spiralbohrer</b> <i>Solid carbide drill</i> Foret hélicoïdal en carbure monobloc	✗	1,0 - 10,0		<b>426</b>
<b>7 x D</b>	<b>PM-HSS-Spiralbohrer</b> <i>Powder metal drill</i> Foret hélicoïdal PM-HSS	✗	2,0 - 13,0		<b>428</b>
<b>8 x D</b>					
<b>8 x D</b>	<b>Vollhartmetall-Spiralbohrer</b> <i>Solid carbide drill</i> Foret hélicoïdal en carbure monobloc	✓	3,0 - 12,0		<b>430</b>
<b>8 x D</b>	<b>Vollhartmetall-Spiralbohrer für Aluminium – diamant beschichtet</b> <i>Solid carbide drill for aluminium – diamond coated</i> Foret hélicoïdal en carbure monobloc pour aluminium avec revêtement diamant	✓	3,0 - 14,0		<b>432</b>
<b>8 x D</b>	<b>Vollhartmetall-Spiralbohrer für rostfreie Stähle</b> <i>Solid carbide drill for stainless steel</i> Foret hélicoïdal en carbure monobloc pour aciers inoxydables	✓	3,0 - 14,0		<b>434</b>
<b>10 x D</b>					
<b>10 x D</b>	<b>Vollhartmetall-Spiralbohrer</b> <i>Solid carbide drill</i> Foret hélicoïdal en carbure monobloc	✓	3,0 - 14,0		<b>436</b>
<b>15 x D</b>					
<b>15 x D</b>	<b>Vollhartmetall-Spiralbohrer</b> <i>Solid carbide drill</i> Foret hélicoïdal en carbure monobloc	✓	3,0 - 12,0		<b>437</b>

# Übersicht Anbohrer und Zentrier

Overview Spot drills and centre drills

Aperçu foret à pointer et de centrage

Ausführung Design Modèle	Bohrertyp Type Type de foret	Innenkühlung Through tool coolant Refroidissement interne	Durchmesser Diameter Diamètre [mm]	Abb. Picture Fig.	Seite Page Page
<b>20xD</b>					
<b>20xD</b>	Vollhartmetall-Spiralbohrer Solid carbide drill Foret hélicoïdal en carbure monobloc	✓	3,0 - 12,0		<b>438</b>
<b>25xD</b>					
<b>25xD</b>	Vollhartmetall-Spiralbohrer Solid carbide drill	✓	12,0 - 50,0		<b>439</b>
<b>30xD</b>					
<b>30xD</b>	Vollhartmetall-Spiralbohrer Solid carbide drill Foret hélicoïdal en carbure monobloc	✓	8,0 - 32,0		<b>440</b>
<b>Anbohrer und Zentrierer / Spot drills and centre drills / Foret à pointer et de centrage</b>					
<b>Anbohrer</b> <i>Spot drills</i> Foret à pointer	Vollhartmetall NC-Anbohrer 90° Solid carbide NC spot drills 90° Foret à pointer en carbure monobloc NC 90°	✗	2,0 - 20,0		<b>441</b>
<b>Anbohrer</b> <i>Spot drills</i> Foret à pointer	Vollhartmetall NC-Anbohrer 120° Solid carbide NC spot drills 120° Foret à pointer en carbure monobloc NC 120°	✗	2,0 - 20,0		<b>442</b>
<b>Anbohrer</b> <i>Spot drills</i> Foret à pointer	Vollhartmetall NC-Anbohrer 135° Solid carbide NC spot drills 135° Foret à pointer en carbure monobloc NC 135°	✗	2,0 - 20,0		<b>443</b>
<b>Anbohrer</b> <i>Spot drills</i> Foret à pointer	PM-HSS NC-Anbohrer 90° Powder metal NC spot drills 90° Foret à pointer PM-HSS NC 90°	✗	2,0 - 20,0		<b>444</b>
<b>Anbohrer</b> <i>Spot drills</i> Foret à pointer	PM-HSS NC-Anbohrer 120° Powder metal NC spot drills 120° Foret à pointer PM-HSS NC 120°	✗	2,0 - 20,0		<b>445</b>
<b>Anbohrer</b> <i>Spot drills</i> Foret à pointer	PM-HSS NC-Anbohrer 135° Powder metal NC spot drills 135° Foret à pointer PM-HSS NC 135°	✗	2,0 - 20,0		<b>446</b>
<b>Zentrierer</b> <i>Centre drills</i> Foret à centrer	Vollhartmetall Zentrierer Solid carbide centre drills Foret de centrage en carbure monobloc	✗	1,0 - 6,3		<b>447</b>
<b>Zentrierer</b> <i>Centre drills</i> Foret à centrer	<b>PM-HSS Zentrierer</b> Powder metal centre drills Foret de centrage PM-HSS	✗	1,0 - 6,3		<b>448</b>

# ARNO®

## WERKZEUGE

We have a passion for precision.

# AUSFÜHRUNG SP

Design SP / Modèle SP

## **Vollhartmetall und PM-HS Spiralbohrer. Höchste Präzision beim Bohren nahezu aller gängigen Werkstoffe.**

*Carbide and powder metal drills to cover all materials.*

Forets hélicoïdaux de précision en carbure monobloc et acier fritté HSS-PM. Grande polyvalence s'adapte à la plupart des matériaux.

Durch ihre spezielle Konstruktion liefern die VHM-Bohrer nicht nur beste Ergebnisse beim Hochgeschwindigkeitsbohren sondern auch bei der Bohrungsqualität und Genauigkeit. Speziell entwickelte Schneidengeometrien und Spankammern sorgen für optimale Spanabfuhr und hervorragenden Spanbruch.

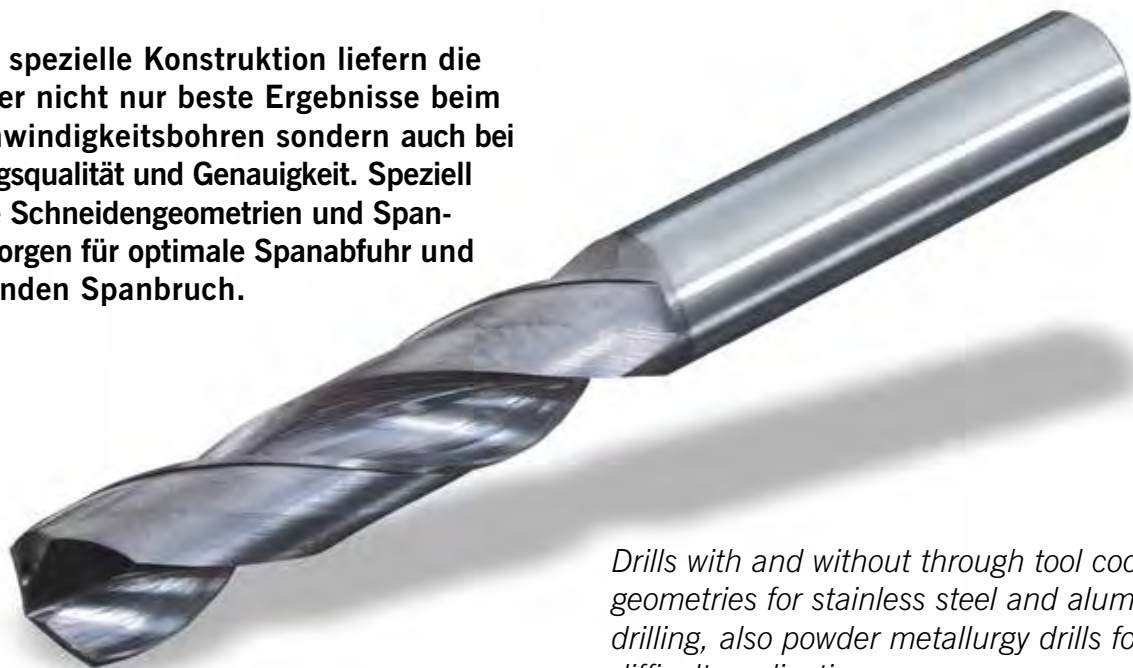

*Drills with and without through tool coolant, geometries for stainless steel and aluminium drilling, also powder metallurgy drills for difficult applications.*

Grâce à leur structure spécifique, les forets en carbure monobloc offrent non seulement les meilleurs résultats en matière de perçage à grande vitesse, mais également en matière de qualité et de précision de perçage. Les géométries de coupe et les poches à copeaux spécialement conçues assurent une évacuation rapide et une excellente fragmentation des copeaux.







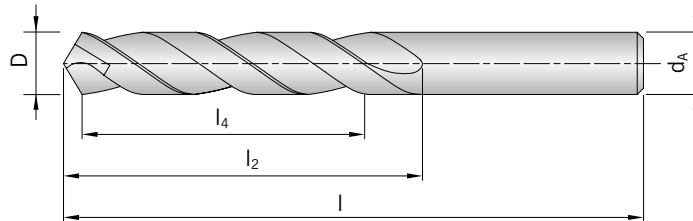

Solid carbide drills

Foret hélicoïdal-carbure monobloc

## Ausführung 3 x D / Execution 3 x D / Version 3 x D

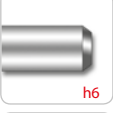
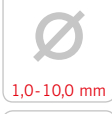
Kurze Ausführung, ohne Innenkühlung / Short design, without through tool coolant /  
Version courte, sans refroidissement interne



-   450-488
-  h7  HA
-  118°  h6
-  1,0-10,0 mm  30°
-  Feinstkorn  
Ultra micro  
granulation  
Grain ultra fin  3  
xD

							PG 24
							unbeschichtet uncoated non-révetu
Schaft Shank Tige	D h7	d <sub>A</sub> h6	l	l <sub>2</sub>	l <sub>4</sub>	VHM/FK	
SP0100-0030	1,0	1,0	26	6	3,0	●	
SP0110-0033	1,1	1,1	28	7	3,3	●	
SP0120-0036	1,2	1,2	30	8	3,6	●	
SP0130-0039	1,3	1,3	30	8	3,9	●	
SP0140-0042	1,4	1,4	32	9	4,2	●	
SP0150-0045	1,5	1,5	32	9	4,5	●	
SP0160-0048	1,6	1,6	34	10	4,8	●	
SP0170-0051	1,7	1,7	34	10	5,1	●	
SP0180-0054	1,8	1,8	36	11	5,4	●	
SP0190-0057	1,9	1,9	36	11	5,7	●	
SP0200-0060	2,0	2,0	38	12	6,0	●	
SP0210-0063	2,1	2,1	38	12	6,3	●	
SP0220-0066	2,2	2,2	40	13	6,6	●	
SP0230-0069	2,3	2,3	40	13	6,9	●	
SP0240-0072	2,4	2,4	43	14	7,2	●	
SP0250-0075	2,5	2,5	43	14	7,5	●	
SP0260-0078	2,6	2,6	43	14	7,8	●	
SP0270-0081	2,7	2,7	46	16	8,1	●	
SP0280-0084	2,8	2,8	46	16	8,4	●	
SP0290-0087	2,9	2,9	46	16	8,7	●	
SP0300-0090	3,0	3,0	46	16	9,0	●	
SP0310-0093	3,1	3,1	49	18	9,3	●	
SP0320-0096	3,2	3,2	49	18	9,6	●	
SP0330-0099	3,3	3,3	49	18	9,9	●	
SP0340-0102	3,4	3,4	52	20	10,2	●	
SP0350-0105	3,5	3,5	52	20	10,5	●	
SP0360-0108	3,6	3,6	52	20	10,8	●	
SP0370-0111	3,7	3,7	52	20	11,1	●	
SP0380-0114	3,8	3,8	52	20	11,4	●	
SP0390-0117	3,9	3,9	55	22	11,7	●	
SP0400-0120	4,0	4,0	55	22	12,0	●	
SP0410-0123	4,1	4,1	55	22	12,3	●	

							PG 24
							unbeschichtet uncoated non-revêtu
Schaft Shank Tige	D h7	d <sub>A</sub> h6	l	l <sub>2</sub>	l <sub>4</sub>	VHM/FK	
SP0420-0126	4,2	4,2	55	22	12,6	●	
SP0430-0129	4,3	4,3	58	24	12,9	●	
SP0440-0132	4,4	4,4	58	24	13,2	●	
SP0450-0135	4,5	4,5	58	24	13,5	●	
SP0460-0138	4,6	4,6	58	24	13,8	●	
SP0470-0141	4,7	4,7	58	24	14,1	●	
SP0480-0144	4,8	4,8	62	26	14,4	●	
SP0490-0147	4,9	4,9	62	26	14,7	●	
SP0500-0150	5,0	5,0	62	26	15,0	●	
SP0510-0153	5,1	5,1	62	26	15,3	●	
SP0520-0156	5,2	5,2	62	26	15,6	●	
SP0530-0159	5,3	5,3	62	26	15,9	●	
SP0550-0165	5,5	5,5	66	28	16,5	●	
SP0560-0168	5,6	5,6	66	28	16,8	●	
SP0570-0171	5,7	5,7	66	28	17,1	●	
SP0580-0174	5,8	5,8	66	28	17,4	●	
SP0590-0177	5,9	5,9	66	28	17,7	●	
SP0600-0180	6,0	6,0	66	28	18,0	●	
SP0610-0183	6,1	6,1	70	31	18,3	●	
SP0620-0186	6,2	6,2	70	31	18,6	●	
SP0640-0192	6,4	6,4	70	31	19,2	●	
SP0650-0195	6,5	6,5	70	31	19,5	●	
SP0660-0198	6,6	6,6	70	31	19,8	●	
SP0670-0201	6,7	6,7	70	31	20,1	●	
SP0680-0204	6,8	6,8	74	34	20,4	●	
SP0690-0207	6,9	6,9	74	34	20,7	●	
SP0700-0210	7,0	7,0	74	34	21,0	●	
SP0730-0219	7,3	7,3	74	34	21,9	●	
SP0750-0225	7,5	7,5	74	34	22,5	●	
SP0780-0234	7,8	7,8	79	37	23,4	●	
SP0800-0240	8,0	8,0	79	37	24,0	●	
SP0810-0243	8,1	8,1	79	37	24,3	●	
SP0850-0255	8,5	8,5	79	37	25,5	●	
SP0860-0258	8,6	8,6	84	40	25,8	●	
SP0880-0264	8,8	8,8	84	40	26,4	●	
SP0890-0267	8,9	8,9	84	40	26,7	●	
SP0900-0270	9,0	9,0	84	40	27,0	●	
SP1000-0300	10,0	10,0	89	43	30,0	●	

P	●
M	○
K	○
N	
S	
H	

- Hauptanwendung  
Main application  
Application principale
- Nebenanwendung  
Secondary application  
Application secondaire

Solid carbide drills

Foret hélicoïdal-carbure monobloc

## Ausführung 3 x D / Execution 3 x D / Version 3 x D

Kurze Ausführung, ohne Innenkühlung / Short design, without through tool coolant /  
Version courte, sans refroidissement interne

450-488

m7 HA

140° h6

1,0-20,0 mm 30°

Feinstkorn  
Ultra micro  
granulation  
Grain ultra fin

3  
xD

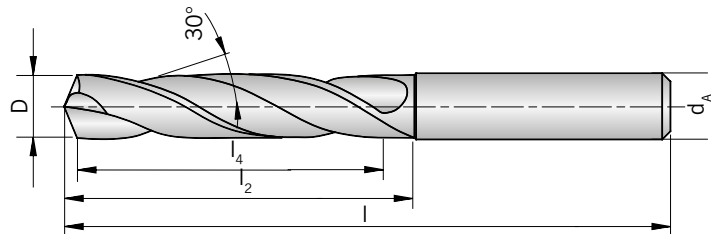

							PG 24
							beschichtet coated revêtu
Schaft Shank Tige	D m7	d <sub>A</sub> h6	l	l <sub>2</sub>	l <sub>4</sub>	TiAIN	
SP0100-0030	1,00	3	45	7	3,0	●	
SP0110-0033	1,10	3	45	7	3,3	●	
SP0120-0036	1,20	3	45	7	3,6	●	
SP0130-0039	1,30	3	45	7	3,9	●	
SP0140-0042	1,40	3	45	7	4,2	●	
SP0150-0045	1,50	3	55	14	4,5	●	
SP0160-0048	1,60	3	55	14	4,8	●	
SP0170-0051	1,70	3	55	14	5,1	●	
SP0180-0054	1,80	3	55	14	5,4	●	
SP0190-0057	1,90	4	55	14	5,7	●	
SP0200-0060	2,00	4	55	20	6,0	●	
SP0210-0063	2,10	4	55	20	6,3	●	
SP0220-0066	2,20	4	55	20	6,6	●	
SP0230-0069	2,30	4	55	20	6,9	●	
SP0240-0072	2,40	4	55	20	7,2	●	
SP0250-0075	2,50	4	55	20	7,5	●	
SP0260-0078	2,60	4	55	20	7,8	●	
SP0270-0081	2,70	4	55	20	8,1	●	
SP0280-0084	2,80	4	55	20	8,4	●	
SP0290-0087	2,90	4	55	20	8,7	●	
SP0300-0090	3,00	6	62	20	9,0	●	
SP0310-0093	3,10	6	62	20	9,3	●	
SP0320-0096	3,20	6	62	20	9,6	●	
SP0330-0099	3,30	6	62	20	9,9	●	
SP0340-0102	3,40	6	62	20	10,2	●	
SP0350-0105	3,50	6	62	20	10,5	●	
SP0360-0108	3,60	6	62	20	10,8	●	
SP0370-0111	3,70	6	62	20	11,1	●	
SP0380-0114	3,80	6	66	24	11,4	●	
SP0390-0117	3,90	6	66	24	11,7	●	
SP0400-0120	4,00	6	66	24	12,0	●	
SP0408-0122	4,08	6	66	24	12,2	●	
SP0410-0123	4,10	6	66	24	12,3	●	

SP



Solid carbide drills

Foret hélicoïdal-carbure monobloc

							PG 24
							beschichtet coated revêtu
Schaft Shank Tige	D m7	d <sub>A</sub> h6	l	l <sub>2</sub>	l <sub>4</sub>	TiAIN	
SP0420-0126	4,20	6	66	24	12,6	●	
SP0425-0128	4,25	6	66	24	12,8	●	
SP0430-0129	4,30	6	66	24	12,9	●	
SP0440-0132	4,40	6	66	24	13,2	●	
SP0450-0135	4,50	6	66	24	13,5	●	
SP0460-0138	4,60	6	66	24	13,8	●	
SP0470-0141	4,70	6	66	24	14,1	●	
SP0480-0144	4,80	6	66	28	14,4	●	
SP0490-0147	4,90	6	66	28	14,7	●	
SP0497-0150	4,97	6	66	28	15,0	●	
SP0500-0150	5,00	6	66	28	15,0	●	
SP0509-0153	5,09	6	66	28	15,3	●	
SP0510-0153	5,10	6	66	28	15,3	●	
SP0520-0156	5,20	6	66	28	15,6	●	
SP0530-0159	5,30	6	66	28	15,9	●	
SP0540-0162	5,40	6	66	28	16,2	●	
SP0550-0165	5,50	6	66	28	16,5	●	
SP0560-0168	5,60	6	66	28	16,8	●	
SP0570-0171	5,70	6	66	28	17,1	●	
SP0580-0174	5,80	6	66	28	17,4	●	
SP0590-0177	5,90	6	66	28	17,7	●	
SP0600-0180	6,00	6	66	28	18,0	●	
SP0609-0183	6,09	8	79	34	18,3	●	
SP0610-0183	6,10	8	79	34	18,3	●	
SP0620-0186	6,20	8	79	34	18,6	●	
SP0630-0189	6,30	8	79	34	18,9	●	
SP0640-0192	6,40	8	79	34	19,2	●	
SP0650-0195	6,50	8	79	34	19,5	●	
SP0655-0197	6,55	8	79	34	19,7	●	
SP0660-0198	6,60	8	79	34	19,8	●	
SP0670-0201	6,70	8	79	34	20,1	●	
SP0680-0204	6,80	8	79	34	20,4	●	
SP0690-0207	6,90	8	79	34	20,7	●	
SP0700-0210	7,00	8	79	34	21,0	●	
SP0710-0213	7,10	8	79	41	21,3	●	
SP0720-0216	7,20	8	79	41	21,6	●	
SP0730-0219	7,30	8	79	41	21,9	●	
SP0740-0222	7,40	8	79	41	22,2	●	
SP0750-0225	7,50	8	79	41	22,5	●	
SP0760-0228	7,60	8	79	41	22,8	●	
SP0770-0231	7,70	8	79	41	23,1	●	
SP0780-0234	7,80	8	79	41	23,4	●	
SP0790-0237	7,90	8	79	41	23,7	●	
SP0800-0240	8,00	8	79	41	24,0	●	
SP0810-0243	8,10	10	89	47	24,3	●	
SP0820-0246	8,20	10	89	47	24,6	●	
SP0830-0249	8,30	10	89	47	24,9	●	
SP0840-0252	8,40	10	89	47	25,2	●	
SP0850-0255	8,50	10	89	47	25,5	●	
SP0860-0258	8,60	10	89	47	25,8	●	
SP0870-0261	8,70	10	89	47	26,1	●	
SP0880-0264	8,80	10	89	47	26,4	●	
SP0890-0267	8,90	10	89	47	26,7	●	
SP0900-0270	9,00	10	89	47	27,0	●	
SP0910-0273	9,10	10	89	47	27,3	●	
SP0920-0276	9,20	10	89	47	27,6	●	

							PG 24
							beschichtet coated revêtu
Schaft Shank Tige	D m7	d <sub>A</sub> h6	l	l <sub>2</sub>	l <sub>4</sub>	TiAIN	
SP0930-0279	9,30	10	89	47	27,9	●	
SP0950-0285	9,50	10	89	47	28,5	●	
SP0970-0291	9,70	10	89	47	29,1	●	
SP0980-0294	9,80	10	89	47	29,4	●	
SP0990-0297	9,90	10	89	47	29,7	●	
SP1000-0300	10,00	10	89	47	30,0	●	
SP1010-0303	10,10	12	102	55	30,3	●	
SP1020-0306	10,20	12	102	55	30,6	●	
SP1030-0309	10,30	12	102	55	30,9	●	
SP1040-0312	10,40	12	102	55	31,2	●	
SP1050-0315	10,50	12	102	55	31,5	●	
SP1060-0318	10,60	12	102	55	31,8	●	
SP1070-0321	10,70	12	102	55	32,1	●	
SP1080-0324	10,80	12	102	55	32,4	●	
SP1090-0327	10,90	12	102	55	32,7	●	
SP1100-0330	11,00	12	102	55	33,0	●	
SP1110-0333	11,10	12	102	55	33,3	●	
SP1120-0336	11,20	12	102	55	33,6	●	
SP1130-0339	11,30	12	102	55	33,9	●	
SP1150-0345	11,50	12	102	55	34,5	●	
SP1170-0351	11,70	12	102	55	35,1	●	
SP1180-0354	11,80	12	102	55	35,4	●	
SP1190-0357	11,90	12	102	55	35,7	●	
SP1200-0360	12,00	12	102	55	36,0	●	
SP1230-0369	12,30	14	107	60	36,9	●	
SP1250-0375	12,50	14	107	60	37,5	●	
SP1280-0384	12,80	14	107	60	38,4	●	
SP1300-0390	13,00	14	107	60	39,0	●	
SP1350-0405	13,50	14	107	60	40,5	●	
SP1380-0414	13,80	14	107	60	41,4	●	
SP1400-0420	14,00	14	107	60	42,0	●	
SP1450-0435	14,50	16	115	65	43,5	●	
SP1480-0444	14,80	16	115	65	44,4	●	
SP1500-0450	15,00	16	115	65	45,0	●	
SP1550-0465	15,50	16	115	65	46,5	●	
SP1580-0474	15,80	16	115	65	47,4	●	
SP1600-0480	16,00	16	115	65	48,0	●	
SP1650-0495	16,50	18	123	73	49,5	●	
SP1700-0510	17,00	18	123	73	51,0	●	
SP1750-0525	17,50	18	123	73	52,5	●	
SP1800-0540	18,00	18	123	73	54,0	●	
SP1850-0555	18,50	20	131	79	55,5	●	
SP1900-0570	19,00	20	131	79	57,0	●	
SP1950-0585	19,50	20	131	79	58,5	●	
SP2000-0600	20,00	20	131	79	60,0	●	

P	●
M	○
K	○
N	
S	
H	

● Hauptanwendung  
Main application  
Application principale

○ Nebenanwendung  
Secondary application  
Application secondaire





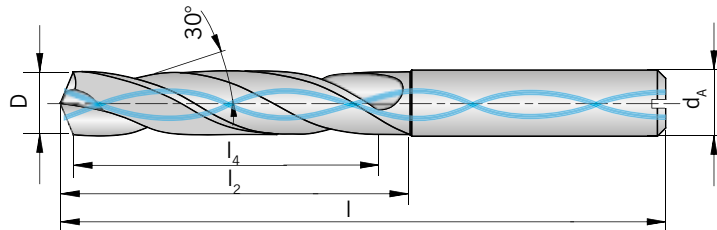

Solid carbide drills

Foret hélicoïdal-carbure monobloc

## Ausführung 3 x D / Execution 3 x D / Version 3 x D

Kurze Ausführung, mit Innenkühlung / Short design, with through tool coolant / Version courte, avec refroidissement interne

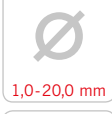

-   450-488
-  m7  HAK
-  140°  h6
-  1,0-20,0 mm  30°
-  **Feinstkorn**  
Ultra micro  
granulation  
Grain ultra fin
-  **3**  
XD

							PG 24
							beschichtet coated revêtu
Schaft Shank Tige	D m7	d <sub>A</sub> h6	l	l <sub>2</sub>	l <sub>4</sub>	TiAIN	
SPC0100-0030	1,00	3	45	7	3,0	●	
SPC0140-0042	1,40	3	45	7	4,2	●	
SPC0150-0045	1,50	3	55	14	4,5	●	
SPC0160-0048	1,60	3	55	14	4,8	●	
SPC0170-0051	1,70	3	55	14	5,1	●	
SPC0180-0054	1,80	3	55	14	5,4	●	
SPC0190-0057	1,90	3	55	14	5,7	●	
SPC0200-0060	2,00	4	55	20	6,0	●	
SPC0210-0063	2,10	4	55	20	6,3	●	
SPC0220-0066	2,20	4	55	20	6,6	●	
SPC0230-0069	2,30	4	55	20	6,9	●	
SPC0240-0072	2,40	4	55	20	7,2	●	
SPC0250-0075	2,50	4	55	20	7,5	●	
SPC0260-0078	2,60	4	55	20	7,8	●	
SPC0270-0081	2,70	4	55	20	8,1	●	
SPC0280-0084	2,80	4	55	20	8,4	●	
SPC0290-0087	2,90	4	55	20	8,7	●	
SPC0300-0090	3,00	6	62	20	9,0	●	
SPC0310-0093	3,10	6	62	20	9,3	●	
SPC0320-0096	3,20	6	62	20	9,6	●	
SPC0325-0098	3,25	6	62	20	9,8	●	
SPC0330-0099	3,30	6	62	20	9,9	●	
SPC0340-0102	3,40	6	62	20	10,2	●	
SPC0350-0105	3,50	6	62	20	10,5	●	
SPC0360-0108	3,60	6	62	20	10,8	●	
SPC0370-0111	3,70	6	62	20	11,1	●	
SPC0380-0114	3,80	6	66	24	11,4	●	
SPC0390-0117	3,90	6	66	24	11,7	●	
SPC0400-0120	4,00	6	66	24	12,0	●	
SPC0410-0123	4,10	6	66	24	12,3	●	
SPC0415-0125	4,15	6	66	24	12,5	●	
SPC0420-0126	4,20	6	66	24	12,6	●	
SPC0430-0129	4,30	6	66	24	12,9	●	

							PG 24
							beschichtet coated revêtu
Schaft Shank Tige	D m7	d <sub>A</sub> h6	l	l <sub>2</sub>	l <sub>4</sub>	TiAIN	
SPC0440-0132	4,40	6	66	24	13,2	●	
SPC0450-0135	4,50	6	66	24	13,5	●	
SPC0460-0138	4,60	6	66	24	13,8	●	
SPC0465-0140	4,65	6	66	24	14,0	●	
SPC0470-0141	4,70	6	66	24	14,1	●	
SPC0480-0144	4,80	6	66	28	14,4	●	
SPC0490-0147	4,90	6	66	28	14,7	●	
SPC0500-0150	5,00	6	66	28	15,0	●	
SPC0510-0153	5,10	6	66	28	15,3	●	
SPC0520-0156	5,20	6	66	28	15,6	●	
SPC0530-0159	5,30	6	66	28	15,9	●	
SPC0540-0162	5,40	6	66	28	16,2	●	
SPC0550-0165	5,50	6	66	28	16,5	●	
SPC0555-0167	5,55	6	66	28	16,7	●	
SPC0560-0168	5,60	6	66	28	16,8	●	
SPC0570-0171	5,70	6	66	28	17,1	●	
SPC0580-0174	5,80	6	66	28	17,4	●	
SPC0590-0177	5,90	6	66	28	17,7	●	
SPC0600-0180	6,00	6	66	28	18,0	●	
SPC0610-0183	6,10	8	79	34	18,3	●	
SPC0620-0186	6,20	8	79	34	18,6	●	
SPC0630-0189	6,30	8	79	34	18,9	●	
SPC0640-0192	6,40	8	79	34	19,2	●	
SPC0650-0195	6,50	8	79	34	19,5	●	
SPC0660-0198	6,60	8	79	34	19,8	●	
SPC0670-0201	6,70	8	79	34	20,1	●	
SPC0680-0204	6,80	8	79	34	20,4	●	
SPC0690-0207	6,90	8	79	34	20,7	●	
SPC0700-0210	7,00	8	79	34	21,0	●	
SPC0710-0213	7,10	8	79	41	21,3	●	
SPC0720-0216	7,20	8	79	41	21,6	●	
SPC0730-0219	7,30	8	79	41	21,9	●	
SPC0740-0222	7,40	8	79	41	22,2	●	
SPC0745-0224	7,45	8	79	41	22,4	●	
SPC0750-0225	7,50	8	79	41	22,5	●	
SPC0760-0228	7,60	8	79	41	22,8	●	
SPC0780-0234	7,80	8	79	41	23,4	●	
SPC0790-0237	7,90	8	79	41	23,7	●	
SPC0800-0240	8,00	8	79	41	24,0	●	
SPC0810-0243	8,10	10	89	47	24,3	●	
SPC0820-0246	8,20	10	89	47	24,6	●	
SPC0830-0249	8,30	10	89	47	24,9	●	
SPC0840-0252	8,40	10	89	47	25,2	●	
SPC0850-0255	8,50	10	89	47	25,5	●	
SPC0860-0258	8,60	10	89	47	25,8	●	
SPC0870-0261	8,70	10	89	47	26,1	●	
SPC0880-0264	8,80	10	89	47	26,4	●	
SPC0890-0267	8,90	10	89	47	26,7	●	
SPC0900-0270	9,00	10	89	47	27,0	●	
SPC0910-0273	9,10	10	89	47	27,3	●	
SPC0930-0279	9,30	10	89	47	27,9	●	
SPC0940-0282	9,40	10	89	47	28,2	●	
SPC0950-0285	9,50	10	89	47	28,5	●	
SPC0960-0288	9,60	10	89	47	28,8	●	
SPC0970-0291	9,70	10	89	47	29,1	●	
SPC0980-0294	9,80	10	89	47	29,4	●	
SPC0990-0297	9,90	10	89	47	29,7	●	

							PG 24
							beschichtet coated revêtu
Schaft Shank Tige	D m7	d <sub>A</sub> h6	l	l <sub>2</sub>	l <sub>4</sub>	TiAIN	
SPC1000-0300	10,00	10	89	47	30,0	●	
SPC1010-0303	10,10	12	102	55	30,3	●	
SPC1020-0306	10,20	12	102	55	30,6	●	
SPC1030-0309	10,30	12	102	55	30,9	●	
SPC1040-0312	10,40	12	102	55	31,2	●	
SPC1050-0315	10,50	12	102	55	31,5	●	
SPC1080-0324	10,80	12	102	55	32,4	●	
SPC1090-0327	10,90	12	102	55	32,7	●	
SPC1100-0330	11,00	12	102	55	33,0	●	
SPC1110-0333	11,10	12	102	55	33,3	●	
SPC1120-0336	11,20	12	102	55	33,6	●	
SPC1130-0339	11,30	12	102	55	33,9	●	
SPC1150-0345	11,50	12	102	55	34,5	●	
SPC1160-0348	11,60	12	102	55	34,8	●	
SPC1170-0351	11,70	12	102	55	35,1	●	
SPC1180-0354	11,80	12	102	55	35,4	●	
SPC1200-0360	12,00	12	102	55	36,0	●	
SPC1220-0366	12,20	14	107	60	36,0	●	
SPC1250-0375	12,50	14	107	60	37,5	●	
SPC1280-0384	12,80	14	107	60	38,4	●	
SPC1300-0390	13,00	14	107	60	39,0	●	
SPC1310-0393	13,10	14	107	60	39,3	●	
SPC1350-0405	13,50	14	107	60	40,5	●	
SPC1380-0414	13,80	14	107	60	41,4	●	
SPC1400-0420	14,00	14	107	60	42,0	●	
SPC1420-0426	14,20	16	115	65	42,6	●	
SPC1450-0435	14,50	16	115	65	43,5	●	
SPC1500-0450	15,00	16	115	65	45,0	●	
SPC1510-0453	15,10	16	115	65	45,3	●	
SPC1520-0456	15,20	16	115	65	45,6	●	
SPC1550-0465	15,50	16	115	65	46,5	●	
SPC1580-0474	15,80	16	115	65	47,4	●	
SPC1600-0480	16,00	16	115	65	48,0	●	
SPC1650-0495	16,50	18	123	73	49,5	●	
SPC1690-0507	16,90	18	123	73	50,7	●	
SPC1700-0510	17,00	18	123	73	51,0	●	
SPC1750-0525	17,50	18	123	73	52,5	●	
SPC1800-0540	18,00	18	123	73	54,0	●	
SPC1850-0555	18,50	20	131	79	55,5	●	
SPC1880-0564	18,80	20	131	79	56,4	●	
SPC1890-0567	18,90	20	131	79	56,7	●	
SPC1900-0570	19,00	20	131	79	57,0	●	
SPC1950-0585	19,50	20	131	79	58,5	●	
SPC1980-0594	19,80	20	131	79	59,4	●	
SPC2000-0600	20,00	20	131	79	60,0	●	

P	●
M	○
K	○
N	
S	
H	

● Hauptanwendung  
Main application  
Application principale

○ Nebenanwendung  
Secondary application  
Application secondaire

Solid carbide drills

Foret hélicoïdal-carbure monobloc

## Ausführung 3 x D für Aluminium / Execution 3 x D for aluminium / Version 3 x D pour aluminium

Kurze Ausführung, mit Innenkühlung, Diamant beschichtet / Short design, with through tool coolant, diamond coated / Version courte, avec refroidissement interne, revêtement diamanté

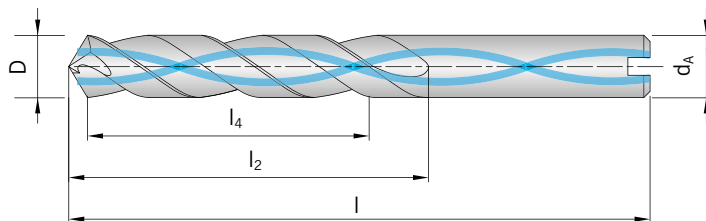

- 
- 
- 
- 
- 
- 
- 
- 
- 
- 
- 

							PG 24
							beschichtet coated revêtu
Schaft Shank Tige	D m7	d <sub>A</sub> h6	l	l <sub>2</sub>	l <sub>4</sub>	DLC	
SPC0300-0090-ALU	3,0	6	62	20	9,0	●	
SPC0320-0096-ALU	3,2	6	62	20	9,6	●	
SPC0380-0114-ALU	3,8	6	66	24	11,4	●	
SPC0400-0120-ALU	4,0	6	66	24	12,0	●	
SPC0450-0135-ALU	4,5	6	66	24	13,5	●	
SPC0500-0150-ALU	5,0	6	66	28	15,0	●	
SPC0510-0153-ALU	5,1	6	66	28	15,3	●	
SPC0600-0180-ALU	6,0	6	66	28	18,0	●	
SPC0640-0192-ALU	6,4	8	79	34	19,2	●	
SPC0680-0204-ALU	6,8	8	79	34	20,4	●	
SPC0700-0210-ALU	7,0	8	79	34	21,0	●	
SPC0750-0225-ALU	7,5	8	79	41	22,5	●	
SPC0800-0240-ALU	8,0	10	79	41	24,0	●	
SPC0860-0258-ALU	8,6	10	89	47	25,8	●	
SPC0880-0264-ALU	8,8	10	89	47	26,4	●	
SPC0900-0270-ALU	9,0	10	89	47	27,0	●	
SPC0910-0273-ALU	9,1	10	89	47	27,3	●	
SPC0940-0282-ALU	9,4	10	89	47	28,2	●	
SPC1000-0300-ALU	10,0	10	89	55	30,0	●	
SPC1100-0330-ALU	11,0	12	102	55	33,0	●	
SPC1200-0360-ALU	12,0	12	102	55	36,0	●	
SPC1300-0390-ALU	13,0	14	107	60	39,0	●	
SPC1400-0420-ALU	14,0	14	107	60	42,0	●	
SPC1500-0450-ALU	15,0	16	115	65	45,0	●	
SPC1600-0480-ALU	16,0	16	115	65	48,0	●	
SPC1700-0510-ALU	17,0	18	123	73	51,0	●	

Solid carbide drills

Foret hélicoïdal-carbure monobloc

							PG 24
							beschichtet coated revêtu
Schaft Shank Tige	D m7	d <sub>A</sub> h6	l	l <sub>2</sub>	l <sub>4</sub>	DLC	
SPC1800-0540-ALU	18,0	18	123	73	54,0	●	
SPC1900-0570-ALU	19,0	20	131	79	57,0	●	
SPC2000-0600-ALU	20,0	20	131	79	60,0	●	

P	
M	
K	
N	●
S	
H	

- **Hauptanwendung**  
Main application  
Application principale
- **Nebenanwendung**  
Secondary application  
Application secondaire







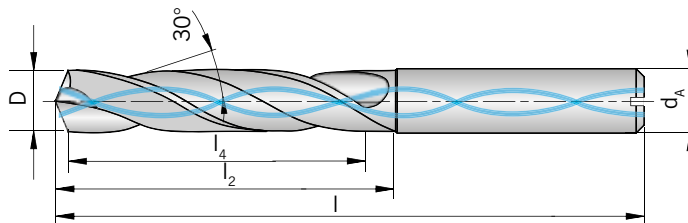

Solid carbide drills

Foret hélicoïdal-carbure monobloc

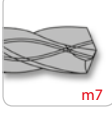
## Ausführung 3 x D für rostfreie Stähle / Execution 3 x D for stainless steel / Version 3 x D pour aciers inoxydables

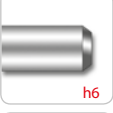
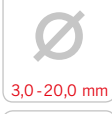
Kurze Ausführung, mit Innenkühlung / Short design, with through tool coolant / Version courte, avec refroidissement interne



-  
-  m7 
-  140° 
-  3,0 - 20,0 mm 
-  
- Feinstkorn**  
Ultra micro granulation  
Grain ultra fin

PG 24

beschichtet  
coated  
revêtu

Schaft Shank Tige	D m7	d <sub>A</sub> h6	l	l <sub>2</sub>	l <sub>4</sub>	TiAIN
SPC0300-0090-VA	3,0	6	62	20	9,0	●
SPC0310-0093-VA	3,1	6	62	20	9,3	●
SPC0320-0096-VA	3,2	6	62	20	9,6	●
SPC0330-0099-VA	3,3	6	62	20	9,9	●
SPC0340-0102-VA	3,4	6	62	20	10,2	●
SPC0350-0105-VA	3,5	6	62	20	10,5	●
SPC0360-0108-VA	3,6	6	62	20	10,8	●
SPC0370-0111-VA	3,7	6	62	20	11,1	●
SPC0380-0114-VA	3,8	6	66	24	11,4	●
SPC0390-0117-VA	3,9	6	66	24	11,7	●
SPC0400-0120-VA	4,0	6	66	24	12,0	●
SPC0410-0123-VA	4,1	6	66	24	12,3	●
SPC0420-0126-VA	4,2	6	66	24	12,6	●
SPC0430-0129-VA	4,3	6	66	24	12,9	●
SPC0440-0132-VA	4,4	6	66	24	13,2	●
SPC0450-0135-VA	4,5	6	66	24	13,5	●
SPC0470-0141-VA	4,7	6	66	24	14,1	●
SPC0480-0144-VA	4,8	6	66	28	14,4	●
SPC0490-0147-VA	4,9	6	66	28	14,7	●
SPC0500-0150-VA	5,0	6	66	28	15,0	●
SPC0510-0153-VA	5,1	6	66	28	15,3	●
SPC0520-0156-VA	5,2	6	66	28	15,6	●
SPC0530-0159-VA	5,3	6	66	28	15,9	●
SPC0540-0162-VA	5,4	6	66	28	16,2	●
SPC0550-0165-VA	5,5	6	66	28	16,5	●
SPC0560-0168-VA	5,6	6	66	28	16,8	●
SPC0570-0171-VA	5,7	6	66	28	17,1	●
SPC0580-0174-VA	5,8	6	66	28	17,4	●
SPC0600-0180-VA	6,0	6	66	28	18,0	●



						PG 24
						beschichtet coated revêtu
Schaft Shank Tige	D m7	d <sub>A</sub> h6	l	l <sub>2</sub>	l <sub>4</sub>	TiAIN
SPC0610-0183-VA	6,1	8	79	34	18,3	●
SPC0620-0186-VA	6,2	8	79	34	18,6	●
SPC0630-0189-VA	6,3	8	79	34	18,9	●
SPC0640-0192-VA	6,4	8	79	34	19,2	●
SPC0650-0195-VA	6,5	8	79	34	19,5	●
SPC0660-0198-VA	6,6	8	79	34	19,8	●
SPC0670-0201-VA	6,7	8	79	34	20,1	●
SPC0680-0204-VA	6,8	8	79	34	20,4	●
SPC0690-0207-VA	6,9	8	79	34	20,7	●
SPC0700-0210-VA	7,0	8	79	34	21,0	●
SPC0720-0216-VA	7,2	8	79	41	21,6	●
SPC0730-0219-VA	7,3	8	79	41	21,9	●
SPC0740-0222-VA	7,4	8	79	41	22,2	●
SPC0750-0225-VA	7,5	8	79	41	22,5	●
SPC0760-0228-VA	7,6	8	79	41	22,8	●
SPC0770-0231-VA	7,7	8	79	41	23,1	●
SPC0780-0234-VA	7,8	8	79	41	23,4	●
SPC0790-0237-VA	7,9	8	79	41	23,7	●
SPC0800-0240-VA	8,0	8	79	41	24,0	●
SPC0810-0243-VA	8,1	10	89	47	24,3	●
SPC0820-0246-VA	8,2	10	89	47	24,6	●
SPC0830-0249-VA	8,3	10	89	47	24,9	●
SPC0850-0255-VA	8,5	10	89	47	25,5	●
SPC0860-0258-VA	8,6	10	89	47	25,8	●
SPC0870-0261-VA	8,7	10	89	47	26,1	●
SPC0880-0264-VA	8,8	10	89	47	26,4	●
SPC0890-0267-VA	8,9	10	89	47	26,7	●
SPC0900-0270-VA	9,0	10	89	47	27,0	●
SPC0920-0276-VA	9,2	10	89	47	27,6	●
SPC0930-0279-VA	9,3	10	89	47	27,9	●
SPC0960-0288-VA	9,6	10	89	47	28,8	●
SPC0980-0294-VA	9,8	10	89	47	29,4	●
SPC0990-0297-VA	9,9	10	89	47	29,7	●
SPC1000-0300-VA	10,0	10	89	47	30,0	●
SPC1010-0303-VA	10,1	12	102	55	30,3	●
SPC1020-0306-VA	10,2	12	102	55	30,6	●
SPC1030-0309-VA	10,3	12	102	55	30,9	●
SPC1050-0315-VA	10,5	12	102	55	31,5	●
SPC1080-0324-VA	10,8	12	102	55	32,4	●
SPC1100-0330-VA	11,0	12	102	55	33,0	●
SPC1110-0333-VA	11,1	12	102	55	33,3	●
SPC1140-0342-VA	11,4	12	102	55	34,2	●
SPC1150-0345-VA	11,5	12	102	55	34,5	●
SPC1170-0351-VA	11,7	12	102	55	35,1	●
SPC1180-0354-VA	11,8	12	102	55	35,4	●
SPC1200-0360-VA	12,0	12	102	55	36,0	●
SPC1250-0375-VA	12,5	14	107	60	37,5	●
SPC1300-0390-VA	13,0	14	107	60	39,0	●
SPC1350-0405-VA	13,5	14	107	60	40,5	●
SPC1400-0420-VA	14,0	14	107	60	42,0	●
SPC1450-0435-VA	14,5	16	115	65	43,5	●
SPC1500-0450-VA	15,0	16	115	65	45,0	●
SPC1550-0465-VA	15,5	16	115	65	46,5	●
SPC1600-0480-VA	16,0	16	115	65	48,0	●
SPC1700-0510-VA	17,0	18	123	73	51,0	●

Solid carbide drills

Foret hélicoïdal-carbure monobloc

							PG 24
							beschichtet coated revêtu
Schaft Shank Tige	D m7	d <sub>A</sub> h6	l	l <sub>2</sub>	l <sub>4</sub>	TITAIN	
SPC1800-0540-VA	18,0	18	123	73	54,0	●	
SPC1900-0570-VA	19,0	20	131	79	57,0	●	
SPC2000-0600-VA	20,0	20	131	79	60,0	●	

P	○
M	●
K	
N	
S	
H	

- **Hauptanwendung**  
Main application  
Application principale
- **Nebenanwendung**  
Secondary application  
Application secondaire

Powder metal drills  
Foret hélicoïdal-PM-HSS

## Ausführung 3 x D Pulvermetallurgisches HSS / Execution 3 x D powder metal drill / Version 3 x D poudre métallurgique HSS

Kurze Ausführung, ohne Innenkühlung / Short design, without through tool coolant / Version courte, sans refroidissement interne

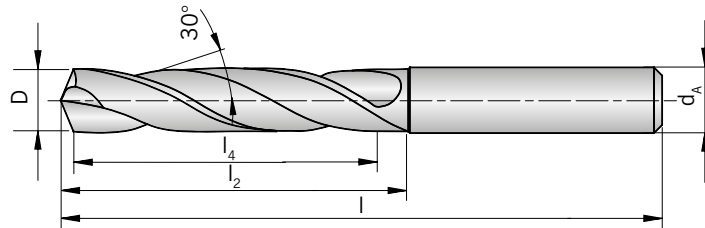
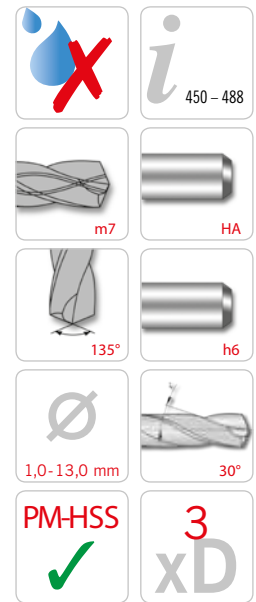

							PG 24
							beschichtet coated revêtu
Schaft Shank Tige	D m7	d <sub>A</sub> h6	l	l <sub>2</sub>	l <sub>4</sub>	TiAIN	
SP0010-0030-PM	1,00	3	38	6	3,00	●	
SP0012-0036-PM	1,20	3	40	8	3,60	●	
SP0013-0039-PM	1,30	3	40	8	3,90	●	
SP0014-0042-PM	1,40	3	41	9	4,20	●	
SP0015-0045-PM	1,50	3	41	9	4,50	●	
SP0016-0048-PM	1,60	3	42	10	4,80	●	
SP0017-0051-PM	1,70	3	42	10	5,10	●	
SP0018-0054-PM	1,80	3	43	11	5,40	●	
SP0020-0060-PM	2,00	3	44	12	6,00	●	
SP0021-0063-PM	2,10	3	44	12	6,30	●	
SP0022-0066-PM	2,20	3	45	13	6,60	●	
SP0024-0072-PM	2,40	3	46	14	7,20	●	
SP0025-0075-PM	2,50	3	46	14	7,50	●	
SP0026-0078-PM	2,60	3	46	14	7,80	●	
SP0028-0084-PM	2,80	3	48	16	8,40	●	
SP0029-0087-PM	2,90	3	48	16	8,70	●	
SP0030-0090-PM	3,00	3	48	16	9,00	●	
SP0031-0093-PM	3,10	4	50	18	9,30	●	
SP0033-0099-PM	3,30	4	50	18	9,90	●	
SP0034-0102-PM	3,40	4	52	20	10,20	●	
SP0035-0105-PM	3,50	4	52	20	10,50	●	
SP0036-0108-PM	3,60	4	52	20	10,80	●	
SP0037-0111-PM	3,70	4	52	20	11,10	●	
SP0040-0120-PM	4,00	4	54	22	12,00	●	
SP0042-0126-PM	4,20	6	66	22	12,60	●	
SP0043-0129-PM	4,30	6	68	24	12,90	●	
SP0044-0132-PM	4,40	6	68	24	13,20	●	
SP0045-0135-PM	4,50	6	68	24	13,50	●	
SP0046-0138-PM	4,60	6	68	24	13,80	●	
SP0047-0141-PM	4,70	6	68	24	14,10	●	

Powder metal drills  
Foret hélicoïdal-PM-HSS

							PG 24
							beschichtet coated revêtu
Schaft Shank Tige	D m7	d <sub>A</sub> h6	l	l <sub>2</sub>	l <sub>4</sub>	TiAIN	
SP0048-0144-PM	4,80	6	70	26	14,40	●	
SP0049-0147-PM	4,90	6	70	26	14,70	●	
SP0050-0150-PM	5,00	6	70	26	15,00	●	
SP0051-0153-PM	5,10	6	70	26	15,30	●	
SP0052-0156-PM	5,20	6	70	26	15,60	●	
SP0055-0165-PM	5,50	6	72	28	16,50	●	
SP00555-01665-PM	5,55	6	72	28	16,65	●	
SP0056-0168-PM	5,60	6	72	28	16,80	●	
SP0058-0174-PM	5,80	6	72	28	17,40	●	
SP0059-0177-PM	5,90	6	72	28	17,70	●	
SP0060-0180-PM	6,00	6	72	28	18,00	●	
SP0061-0183-PM	6,10	8	75	31	18,30	●	
SP0062-0186-PM	6,20	8	75	31	18,60	●	
SP0065-0195-PM	6,50	8	75	31	19,50	●	
SP0066-0198-PM	6,60	8	75	31	19,80	●	
SP0068-0204-PM	6,80	8	78	34	20,40	●	
SP0069-0207-PM	6,90	8	78	34	20,70	●	
SP0070-0210-PM	7,00	8	78	34	21,00	●	
SP0072-0216-PM	7,20	8	78	34	21,60	●	
SP0074-0222-PM	7,40	8	78	34	22,20	●	
SP0075-0225-PM	7,50	8	78	34	22,50	●	
SP0076-0228-PM	7,60	8	81	37	22,80	●	
SP0078-0234-PM	7,80	8	81	37	23,40	●	
SP0079-0237-PM	7,90	8	81	37	23,70	●	
SP0080-0240-PM	8,00	8	81	37	24,00	●	
SP0081-0243-PM	8,10	10	87	37	24,30	●	
SP0082-0246-PM	8,20	10	87	37	24,60	●	
SP0083-0249-PM	8,30	10	87	37	24,90	●	
SP0084-0252-PM	8,40	10	87	37	25,20	●	
SP0085-0255-PM	8,50	10	87	37	25,50	●	
SP0087-0261-PM	8,70	10	90	40	26,10	●	
SP0090-0270-PM	9,00	10	90	40	27,00	●	
SP0097-0291-PM	9,70	10	93	43	29,10	●	
SP0099-0297-PM	9,90	10	93	43	29,70	●	
SP0100-0300-PM	10,00	10	93	43	30,00	●	
SP0102-0306-PM	10,20	12	100	43	30,60	●	
SP0103-0309-PM	10,30	12	100	43	30,90	●	
SP0105-0315-PM	10,50	12	100	43	31,50	●	
SP0110-0330-PM	11,00	12	104	47	33,00	●	
SP0114-0342-PM	11,40	12	104	47	34,20	●	
SP0115-0345-PM	11,50	12	104	47	34,50	●	
SP0120-0360-PM	12,00	12	108	51	36,00	●	
SP0121-0363-PM	12,10	12	108	51	36,30	●	
SP0122-0366-PM	12,20	12	108	51	36,60	●	
SP0125-0375-PM	12,50	12	108	51	37,50	●	
SP0130-0390-PM	13,00	12	108	51	39,00	●	

P	●
M	○
K	○
N	
S	
H	

● Hauptanwendung  
Main application  
Application principale

e







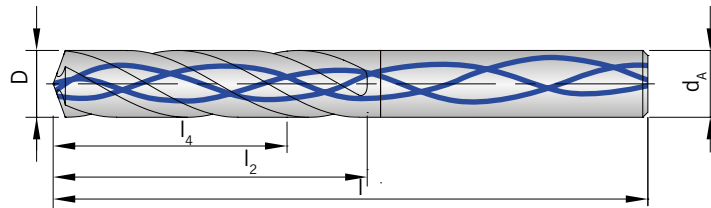

Solid carbide drills

Foret hélicoïdal-carbure monobloc

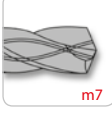
## Ausführung 3 x D / Execution 3 x D / Version 3 x D

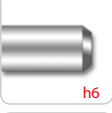
3 Schneiden, kurze Ausführung mit Innenkühlung / 3 flutes, short design with through tool coolant / 3 dents, version courte avec refroidissement interne

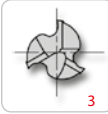

-   450-488
-  m7  HAK
-  140°  h6
-  5,0 - 20,0 mm  30°
-  3  Feinstkorn  
Ultra micro granulation  
Grain ultra fin  3  
XD

**N** NEU/NEW/NOUVEAU

							PG 24
							beschichtet coated revêtu
Schaft Shank Tige	D m7	d <sub>A</sub> h6	l	l <sub>2</sub>	l <sub>4</sub>	S200	
SPC0500-0150-3S <b>N</b>	5,0	6	66	28	15,0	●	
SPC0510-0153-3S <b>N</b>	5,1	6	66	28	15,3	●	
SPC0510-0153-3S <b>N</b>	5,2	6	66	28	15,6	●	
SPC0530-0159-3S <b>N</b>	5,3	6	66	28	15,9	●	
SPC0540-0162-3S <b>N</b>	5,4	6	66	28	16,2	●	
SPC0550-0165-3S <b>N</b>	5,5	6	66	28	16,5	●	
SPC0560-0165-3S <b>N</b>	5,6	6	66	28	16,8	●	
SPC0570-0165-3S <b>N</b>	5,7	6	66	28	17,1	●	
SPC0580-0174-3S <b>N</b>	5,8	6	66	28	17,4	●	
SPC0590-0177-3S <b>N</b>	5,9	6	66	28	17,7	●	
SPC0600-0180-3S <b>N</b>	6,0	6	66	28	18,0	●	
SPC0610-0183-3S <b>N</b>	6,1	8	79	34	18,3	●	
SPC0620-0186-3S <b>N</b>	6,2	8	79	34	18,6	●	
SPC0630-0189-3S <b>N</b>	6,3	8	79	34	18,9	●	
SPC0640-0192-3S <b>N</b>	6,4	8	79	34	19,2	●	
SPC0650-0195-3S <b>N</b>	6,5	8	79	34	19,5	●	
SPC0660-0198-3S <b>N</b>	6,6	8	79	34	19,8	●	
SPC0670-0201-3S <b>N</b>	6,7	8	79	34	20,1	●	
SPC0680-0204-3S <b>N</b>	6,8	8	79	34	20,4	●	
SPC0680-0204-3S <b>N</b>	6,9	8	79	34	20,7	●	
SPC0700-0210-3S <b>N</b>	7,0	8	79	34	21,0	●	
SPC0710-0213-3S <b>N</b>	7,1	8	79	41	21,3	●	
SPC0720-0216-3S <b>N</b>	7,2	8	79	41	21,6	●	
SPC0730-0219-3S <b>N</b>	7,3	8	79	41	21,9	●	
SPC0740-0222-3S <b>N</b>	7,4	8	79	41	22,2	●	
SPC0750-0225-3S <b>N</b>	7,5	8	79	41	22,5	●	
SPC0760-0228-3S <b>N</b>	7,6	8	79	41	22,8	●	
SPC0770-0231-3S <b>N</b>	7,7	8	79	41	22,8	●	
SPC0780-0234-3S <b>N</b>	7,8	8	79	41	23,4	●	

							PG 24
							beschichtet coated revêtu
Schaft Shank Tige	D m7	d <sub>A</sub> h6	l	l <sub>2</sub>	l <sub>4</sub>	S200	
SPC0790-0237-3S	7,9	8	79	41	23,7	●	
SPC0800-0240-3S	8,0	8	79	41	24,0	●	
SPC0810-0243-3S	8,1	10	89	47	24,3	●	
SPC0820-0246-3S	8,2	10	89	47	24,3	●	
SPC0830-0249-3S	8,3	10	89	47	24,9	●	
SPC0840-0252-3S	8,4	10	89	47	25,2	●	
SPC0850-0255-3S	8,5	10	89	47	25,5	●	
SPC0860-0258-3S	8,6	10	89	47	25,8	●	
SPC0870-0261-3S	8,7	10	89	47	26,1	●	
SPC0880-0264-3S	8,8	10	89	47	26,4	●	
SPC0890-0267-3S	8,9	10	89	47	26,7	●	
SPC0900-0270-3S	9,0	10	89	47	27,0	●	
SPC0910-0273-3S	9,1	10	89	47	27,3	●	
SPC0920-0276-3S	9,2	10	89	47	27,6	●	
SPC0930-0279-3S	9,3	10	89	47	27,9	●	
SPC0940-0282-3S	9,4	10	89	47	28,2	●	
SPC0950-0285-3S	9,5	10	89	47	28,5	●	
SPC0960-0288-3S	9,6	10	89	47	28,8	●	
SPC0970-0291-3S	9,7	10	89	47	29,1	●	
SPC0980-0294-3S	9,8	10	89	47	29,4	●	
SPC0990-0297-3S	9,9	10	89	47	29,7	●	
SPC1000-0300-3S	10,0	10	89	47	30,0	●	
SPC1010-0303-3S	10,1	12	102	55	30,3	●	
SPC1020-0306-3S	10,2	12	102	55	30,6	●	
SPC1030-0309-3S	10,3	12	102	55	30,9	●	
SPC1040-0312-3S	10,4	12	102	55	31,2	●	
SPC1050-0315-3S	10,5	12	102	55	31,5	●	
SPC1060-0318-3S	10,6	12	102	55	31,8	●	
SPC1070-0321-3S	10,7	12	102	55	32,1	●	
SPC1080-0324-3S	10,8	12	102	55	32,4	●	
SPC1090-0327-3S	10,9	12	102	55	32,7	●	
SPC1100-0330-3S	11,0	12	102	55	33,0	●	
SPC1110-0333-3S	11,1	12	102	55	33,3	●	
SPC1120-0336-3S	11,2	12	102	55	33,6	●	
SPC1130-0339-3S	11,3	12	102	55	33,9	●	
SPC1140-0342-3S	11,4	12	102	55	34,2	●	
SPC1150-0345-3S	11,5	12	102	55	34,5	●	
SPC1160-0348-3S	11,6	12	102	55	34,8	●	
SPC1170-0351-3S	11,7	12	102	55	35,1	●	
SPC1180-0354-3S	11,8	12	102	55	35,4	●	
SPC1190-0357-3S	11,9	12	102	55	35,7	●	
SPC1200-0360-3S	12,0	12	102	55	36,0	●	
SPC1250-0375-3S	12,5	14	107	60	37,5	●	
SPC1300-0390-3S	13,0	14	107	60	39,0	●	
SPC1350-0405-3S	13,5	14	107	60	40,5	●	
SPC1400-0420-3S	14,0	14	107	60	42,0	●	
SPC1450-0435-3S	14,5	16	115	65	43,5	●	
SPC1500-0450-3S	15,0	16	115	65	45,0	●	
SPC1550-0465-3S	15,5	16	115	65	46,5	●	
SPC1600-0480-3S	16,0	16	115	65	48,0	●	
SPC1650-0495-3S	16,5	18	123	73	49,5	●	
SPC1700-0510-3S	17,0	18	123	73	51,0	●	

Solid carbide drills

Foret hélicoïdal-carbure monobloc

							PG 24
							beschichtet coated revêtu
Schaft Shank Tige	D m7	d <sub>A</sub> h6	l	l <sub>2</sub>	l <sub>4</sub>	S200	
SPC1750-0525-3S <span style="color: red;">N</span>	17,5	18	123	73	52,5	●	
SPC1800-0540-3S <span style="color: red;">N</span>	18,0	18	123	73	54,0	●	
SPC1850-0555-3S <span style="color: red;">N</span>	18,5	20	131	79	55,5	●	
SPC1900-0570-3S <span style="color: red;">N</span>	19,0	20	131	79	57,0	●	
SPC1950-0585-3S <span style="color: red;">N</span>	19,5	20	131	79	58,5	●	
SPC2000-0600-3S <span style="color: red;">N</span>	20,0	20	131	79	60,0	●	

P	●
M	○
K	○
N	
S	
H	

- **Hauptanwendung**  
Main application  
Application principale
- **Nebenanwendung**  
Secondary application  
Application secondaire

Solid carbide drills

Foret hélicoïdal-carbure monobloc

## Ausführung 5 x D / Execution 5 x D / Version 5 x D

Mittellange Ausführung, ohne Innenkühlung / Mid-length design, without through tool coolant / Version mi-longue, sans refroidissement interne

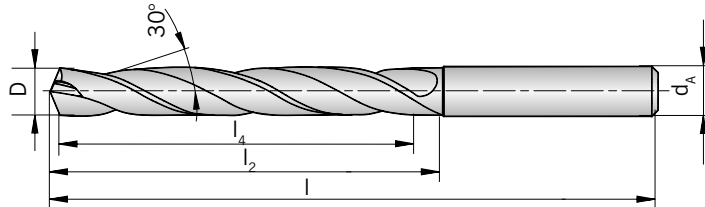
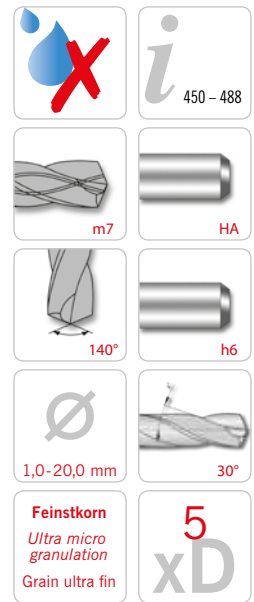

							PG 24
							beschichtet coated revêtu
Schaft Shank Tige	D m7	d <sub>A</sub> h6	l	l <sub>2</sub>	l <sub>4</sub>	TiAIN	
SP0010-0050	1,0	3	55	8	5,0	●	
SP0011-0055	1,1	3	55	12	5,5	●	
SP0012-0060	1,2	3	55	12	6,0	●	
SP0013-0065	1,3	3	55	12	6,5	●	
SP0014-0070	1,4	3	55	12	7,0	●	
SP0015-0075	1,5	3	55	16	7,5	●	
SP0016-0080	1,6	3	55	16	8,0	●	
SP0017-0085	1,7	3	55	16	8,5	●	
SP0018-0090	1,8	3	55	16	9,0	●	
SP0019-0095	1,9	3	55	16	9,5	●	
SP0020-0100	2,0	4	57	21	10,0	●	
SP0021-0105	2,1	4	57	21	10,5	●	
SP0022-0110	2,2	4	57	21	11,0	●	
SP0023-0115	2,3	4	57	21	11,5	●	
SP0024-0120	2,4	4	57	21	12,0	●	
SP0025-0125	2,5	4	57	21	12,5	●	
SP0026-0130	2,6	4	57	21	13,0	●	
SP0027-0135	2,7	4	57	21	13,5	●	
SP0028-0140	2,8	4	57	21	14,0	●	
SP0029-0145	2,9	4	57	21	14,5	●	
SP0030-0150	3,0	6	66	28	15,0	●	
SP0031-0155	3,1	6	66	28	15,5	●	
SP0032-0160	3,2	6	66	28	16,0	●	
SP0033-0165	3,3	6	66	28	16,5	●	
SP0034-0170	3,4	6	66	28	17,0	●	
SP0035-0175	3,5	6	66	28	17,5	●	
SP0036-0180	3,6	6	66	28	18,0	●	
SP0037-0185	3,7	6	66	28	18,5	●	
SP0038-0190	3,8	6	74	36	19,0	●	
SP0039-0195	3,9	6	74	36	19,5	●	
SP0040-0200	4,0	6	74	36	20,0	●	
SP0041-0205	4,1	6	74	36	20,5	●	



Solid carbide drills

Foret hélicoïdal-carbure monobloc

							PG 24
							beschichtet coated revêtu
Schaft Shank Tige	D m7	d <sub>A</sub> h6	l	l <sub>2</sub>	l <sub>4</sub>	TiAIN	
SP0042-0210	4,2	6	74	36	21,0	●	
SP0043-0215	4,3	6	74	36	21,5	●	
SP0044-0220	4,4	6	74	36	22,0	●	
SP0045-0225	4,5	6	74	36	22,5	●	
SP0046-0230	4,6	6	74	36	23,0	●	
SP0047-0235	4,7	6	74	36	23,5	●	
SP0048-0240	4,8	6	82	44	24,0	●	
SP0049-0245	4,9	6	82	44	24,5	●	
SP0050-0250	5,0	6	82	44	25,0	●	
SP0051-0255	5,1	6	82	44	25,5	●	
SP0052-0260	5,2	6	82	44	26,0	●	
SP0053-0265	5,3	6	82	44	26,5	●	
SP0054-0270	5,4	6	82	44	27,0	●	
SP0055-0275	5,5	6	82	44	27,5	●	
SP0056-0280	5,6	6	82	44	28,0	●	
SP0057-0285	5,7	6	82	44	28,5	●	
SP0058-0290	5,8	6	82	44	29,0	●	
SP0059-0295	5,9	6	82	44	29,5	●	
SP0060-0300	6,0	6	82	44	30,0	●	
SP0061-0305	6,1	8	91	53	30,5	●	
SP0062-0310	6,2	8	91	53	31,0	●	
SP0063-0315	6,3	8	91	53	31,5	●	
SP0064-0320	6,4	8	91	53	32,0	●	
SP0065-0325	6,5	8	91	53	32,5	●	
SP0066-0330	6,6	8	91	53	33,0	●	
SP0067-0335	6,7	8	91	53	33,5	●	
SP0068-0340	6,8	8	91	53	34,0	●	
SP0069-0345	6,9	8	91	53	34,5	●	
SP0070-0350	7,0	8	91	53	35,0	●	
SP0071-0355	7,1	8	91	53	35,5	●	
SP0072-0360	7,2	8	91	53	36,0	●	
SP0073-0365	7,3	8	91	53	36,5	●	
SP0074-0370	7,4	8	91	53	37,0	●	
SP0075-0375	7,5	8	91	53	37,5	●	
SP0076-0380	7,6	8	91	53	38,0	●	
SP0077-0385	7,7	8	91	53	38,5	●	
SP0078-0390	7,8	8	91	53	39,0	●	
SP0079-0395	7,9	8	91	53	39,5	●	
SP0080-0400	8,0	8	91	53	40,0	●	
SP0081-0405	8,1	10	103	61	40,5	●	
SP0082-0410	8,2	10	103	61	41,0	●	
SP0083-0415	8,3	10	103	61	41,5	●	
SP0085-0425	8,5	10	103	61	42,5	●	
SP0086-0430	8,6	10	103	61	43,0	●	
SP0087-0435	8,7	10	103	61	43,5	●	
SP0088-0440	8,8	10	103	61	44,0	●	
SP0089-0445	8,9	10	103	61	44,5	●	
SP0090-0450	9,0	10	103	61	45,0	●	
SP0091-0455	9,1	10	103	61	45,5	●	
SP0092-0460	9,2	10	103	61	46,0	●	
SP0093-0465	9,3	10	103	61	46,5	●	
SP0095-0475	9,5	10	103	61	47,5	●	
SP0096-0480	9,6	10	103	61	48,0	●	
SP0097-0485	9,7	10	103	61	48,5	●	
SP0098-0490	9,8	10	103	61	49,0	●	
SP0099-0495	9,9	10	103	61	49,5	●	

Solid carbide drills

Foret hélicoïdal-carbure monobloc

							PG 24
							beschichtet coated revêtu
Schaft Shank Tige	D m7	d <sub>A</sub> h6	l	l <sub>2</sub>	l <sub>4</sub>	TiAIN	
SP0100-0500	10,0	10	103	61	50,0	●	
SP0101-0505	10,1	12	118	71	50,5	●	
SP0102-0510	10,2	12	118	71	51,0	●	
SP0103-0515	10,3	12	118	71	51,5	●	
SP0104-0520	10,4	12	118	71	52,0	●	
SP0105-0525	10,5	12	118	71	52,5	●	
SP0106-0530	10,6	12	118	71	53,0	●	
SP0110-0550	11,0	12	118	71	55,0	●	
SP0112-0560	11,2	12	118	71	56,0	●	
SP0115-0575	11,5	12	118	71	57,5	●	
SP0118-0590	11,8	12	118	71	59,0	●	
SP0120-0600	12,0	12	118	71	60,0	●	
SP0125-0625	12,5	14	124	77	62,5	●	
SP0128-0640	12,8	14	124	77	64,0	●	
SP0130-0650	13,0	14	124	77	65,0	●	
SP0135-0675	13,5	14	124	77	67,5	●	
SP0138-0690	13,8	14	124	77	69,0	●	
SP0140-0700	14,0	14	124	77	70,0	●	
SP0145-0725	14,5	16	133	83	72,5	●	
SP0150-0750	15,0	16	133	83	75,0	●	
SP0158-0790	15,8	16	133	83	79,0	●	
SP0160-0800	16,0	16	133	83	80,0	●	
SP0170-0850	17,0	18	143	93	85,0	●	
SP0175-0875	17,5	18	143	93	87,5	●	
SP0180-0900	18,0	18	143	93	90,0	●	
SP0185-0925	18,5	20	153	101	92,5	●	
SP0190-0950	19,0	20	153	101	95,0	●	
SP0195-0975	19,5	20	153	101	97,5	●	
SP0198-0990	19,8	20	153	101	99,0	●	
SP0200-1000	20,0	20	153	101	100,0	●	

P	●
M	○
K	○
N	
S	
H	

● Hauptanwendung  
Main application  
Application principale

○ Nebenanwendung  
Secondary application  
Application secondaire

Solid carbide drills

Foret hélicoïdal-carbure monobloc

## Ausführung 5 x D / Execution 5 x D / Version 5 x D

Mittellange Ausführung, mit Innenkühlung / Mid-length design, with through tool coolant / Version mi-longue avec refroidissement interne

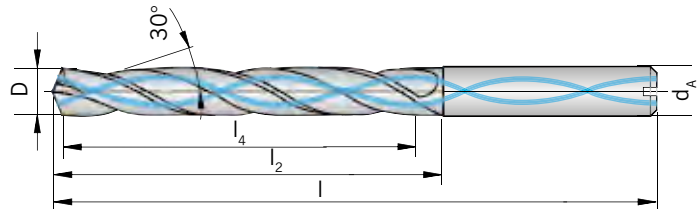

450 - 488

m7

HAK

140°

h6

1,0-20,0 mm

30°

**Feinstkorn**  
Ultra micro  
granulation  
Grain ultra fin

**5**  
xD

							PG 24
							beschichtet coated revêtu
Schaft Shank Tige	D m7	d <sub>A</sub> h6	l	l <sub>2</sub>	l <sub>4</sub>	TiAIN	
SPC0010-0050	1,00	3	55	8	5,0	●	
SPC0011-0055	1,10	3	55	12	5,5	●	
SPC0012-0060	1,20	3	55	12	6,0	●	
SPC0013-0065	1,30	3	55	12	6,5	●	
SPC0014-0070	1,40	3	55	12	7,0	●	
SPC0015-0075	1,50	3	55	16	7,5	●	
SPC0016-0080	1,60	3	55	16	8,0	●	
SPC0017-0085	1,70	3	55	16	8,5	●	
SPC0018-0090	1,80	3	55	16	9,0	●	
SPC0019-0095	1,90	3	55	16	9,5	●	
SPC0020-0100	2,00	4	57	21	10,0	●	
SPC0021-0105	2,10	4	57	21	10,5	●	
SPC0022-0110	2,20	4	57	21	11,0	●	
SPC0023-0115	2,30	4	57	21	11,5	●	
SPC0024-0120	2,40	4	57	21	12,0	●	
SPC0025-0125	2,50	4	57	21	12,5	●	
SPC0026-0130	2,60	4	57	21	13,0	●	
SPC0027-0135	2,70	4	57	21	13,5	●	
SPC0028-0140	2,80	4	57	21	14,0	●	
SPC0029-0145	2,90	4	57	21	14,5	●	
SPC0030-0150	3,00	6	66	28	15,0	●	
SPC0031-0155	3,10	6	66	28	15,5	●	
SPC0032-0160	3,20	6	66	28	16,0	●	
SPC0033-0165	3,30	6	66	28	16,5	●	
SPC0034-0170	3,40	6	66	28	17,0	●	
SPC0035-0175	3,50	6	66	28	17,5	●	
SPC0036-0180	3,60	6	66	28	18,0	●	
SPC0037-0185	3,70	6	66	28	18,5	●	
SPC0038-0190	3,80	6	74	36	19,0	●	
SPC0039-0195	3,90	6	74	36	19,5	●	
SPC0040-0200	4,00	6	74	36	20,0	●	
SPC0041-0205	4,10	6	74	36	20,5	●	

							PG 24
							beschichtet coated revêtu
Schaft Shank Tige	D m7	d <sub>A</sub> h6	l	l <sub>2</sub>	l <sub>4</sub>	TiAIN	
SPC0042-0210	4,20	6	74	36	21,0	●	
SPC0043-0215	4,30	6	74	36	21,5	●	
SPC0044-0220	4,40	6	74	36	22,0	●	
SPC0045-0225	4,50	6	74	36	22,5	●	
SPC0046-0230	4,60	6	74	36	23,0	●	
SPC00465-0233	4,65	6	74	36	23,3	●	
SPC0047-0235	4,70	6	74	36	23,5	●	
SPC0048-0240	4,80	6	82	44	24,0	●	
SPC0049-0245	4,90	6	82	44	24,5	●	
SPC0050-0250	5,00	6	82	44	25,0	●	
SPC0051-0255	5,10	6	82	44	25,5	●	
SPC0052-0260	5,20	6	82	44	26,0	●	
SPC0053-0265	5,30	6	82	44	26,5	●	
SPC0054-0270	5,40	6	82	44	27,0	●	
SPC0055-0275	5,50	6	82	44	27,5	●	
SPC00555-0278	5,55	6	82	44	27,8	●	
SPC0056-0280	5,60	6	82	44	28,0	●	
SPC0057-0285	5,70	6	82	44	28,5	●	
SPC0058-0290	5,80	6	82	44	29,0	●	
SPC0059-0295	5,90	6	82	44	29,5	●	
SPC0060-0300	6,00	6	82	44	30,0	●	
SPC0061-0305	6,10	8	91	53	30,5	●	
SPC0062-0310	6,20	8	91	53	31,0	●	
SPC0063-0315	6,30	8	91	53	31,5	●	
SPC0064-0320	6,40	8	91	53	32,0	●	
SPC0065-0325	6,50	8	91	53	32,5	●	
SPC0066-0330	6,60	8	91	53	33,0	●	
SPC0067-0335	6,70	8	91	53	33,5	●	
SPC0068-0340	6,80	8	91	53	34,0	●	
SPC0069-0345	6,90	8	91	53	34,5	●	
SPC0070-0350	7,00	8	91	53	35,0	●	
SPC0071-0355	7,10	8	91	53	35,5	●	
SPC0072-0360	7,20	8	91	53	36,0	●	
SPC0073-0365	7,30	8	91	53	36,5	●	
SPC0074-0370	7,40	8	91	53	37,0	●	
SPC0075-0375	7,50	8	91	53	37,5	●	
SPC0076-0380	7,60	8	91	53	38,0	●	
SPC0077-0385	7,70	8	91	53	38,5	●	
SPC0078-0390	7,80	8	91	53	39,0	●	
SPC0079-0395	7,90	8	91	53	39,5	●	
SPC0080-0400	8,00	8	91	53	40,0	●	
SPC0081-0405	8,10	10	103	61	40,5	●	
SPC0082-0410	8,20	10	103	61	41,0	●	
SPC0083-0415	8,30	10	103	61	41,5	●	
SPC0084-0420	8,40	10	103	61	42,0	●	
SPC0085-0425	8,50	10	103	61	42,5	●	
SPC0086-0430	8,60	10	103	61	43,0	●	
SPC0087-0435	8,70	10	103	61	43,5	●	
SPC0088-0440	8,80	10	103	61	44,0	●	
SPC0089-0445	8,90	10	103	61	44,5	●	
SPC0090-0450	9,00	10	103	61	45,0	●	
SPC0091-0455	9,10	10	103	61	45,5	●	
SPC0092-0460	9,20	10	103	61	46,0	●	
SPC0093-0465	9,30	10	103	61	46,5	●	
SPC0094-0470	9,40	10	103	61	47,0	●	
SPC0095-0475	9,50	10	103	61	47,5	●	

							PG 24
							beschichtet coated revêtu
Schaft Shank Tige	D m7	d <sub>A</sub> h6	l	l <sub>2</sub>	l <sub>4</sub>	TiAIN	
SPC0096-0480	9,60	10	103	61	48,0	●	
SPC0097-0485	9,70	10	103	61	48,5	●	
SPC0098-0490	9,80	10	103	61	49,0	●	
SPC0099-0495	9,90	10	103	61	49,5	●	
SPC0100-0500	10,00	10	103	61	50,0	●	
SPC0101-0505	10,10	12	118	71	50,5	●	
SPC0102-0510	10,20	12	118	71	51,0	●	
SPC0103-0515	10,30	12	118	71	51,5	●	
SPC0104-0520	10,40	12	118	71	52,0	●	
SPC0105-0525	10,50	12	118	71	52,5	●	
SPC0106-0530	10,60	12	118	71	53,0	●	
SPC0108-0540	10,80	12	118	71	54,0	●	
SPC0110-0550	11,00	12	118	71	55,0	●	
SPC0111-0555	11,10	12	118	71	55,5	●	
SPC0112-0560	11,20	12	118	71	56,0	●	
SPC0113-0565	11,30	12	118	71	56,5	●	
SPC0114-0570	11,40	12	118	71	57,0	●	
SPC0115-0575	11,50	12	118	71	57,5	●	
SPC0116-0580	11,60	12	118	71	58,0	●	
SPC0117-0585	11,70	12	118	71	58,5	●	
SPC0118-0590	11,80	12	118	71	59,0	●	
SPC0119-0595	11,90	12	118	71	59,5	●	
SPC0120-0600	12,00	12	118	71	60,0	●	
SPC0125-0625	12,50	14	124	77	62,5	●	
SPC0127-0635	12,70	14	124	77	63,5	●	
SPC0128-0640	12,80	14	124	77	64,0	●	
SPC0130-0650	13,00	14	124	77	65,0	●	
SPC0132-0660	13,20	14	124	77	66,0	●	
SPC0135-0675	13,50	14	124	77	67,5	●	
SPC0140-0700	14,00	14	124	77	70,0	●	
SPC0142-0710	14,20	16	133	83	71,0	●	
SPC0145-0725	14,50	16	133	83	72,5	●	
SPC0150-0750	15,00	16	133	83	75,0	●	
SPC0155-0775	15,50	16	133	83	77,5	●	
SPC0160-0800	16,00	16	133	83	80,0	●	
SPC0165-0825	16,50	18	143	93	82,5	●	
SPC0170-0850	17,00	18	143	93	85,0	●	
SPC0175-0875	17,50	18	143	93	87,5	●	
SPC0180-0900	18,00	18	143	93	90,0	●	
SPC0185-0925	18,50	20	153	101	92,5	●	
SPC0190-0950	19,00	20	153	101	95,0	●	
SPC0200-1000	20,00	20	153	101	100,0	●	

P	●
M	○
K	○
N	
S	
H	

● Hauptanwendung  
Main application  
Application principale

○ Nebenanwendung  
Secondary application  
Application secondaire

Solid carbide drills

Foret hélicoïdal-carbure monobloc

## Ausführung 5 x D für Aluminium / Execution 5 x D for aluminium / Version 5 x D pour aluminium

Mittellange Ausführung, mit Innenkühlung, Diamant beschichtet / Mid-length design, with through tool coolant, diamond coated / Version mi-longue avec refroidissement interne, revêtement diamanté

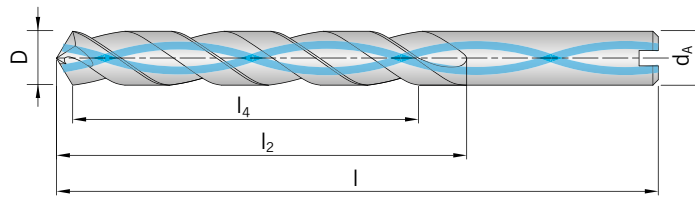

- 
- 
- 
- 
- 
- 
- 
- 
- 
- 
- 

							PG 24
							beschichtet coated revêtu
Schaft Shank Tige	D m7	d <sub>A</sub> h6	l	l <sub>2</sub>	l <sub>4</sub>	DLC	
SPC0030-0150-ALU	3,0	6	66	28	15,0	●	
SPC0033-0165-ALU	3,3	6	66	28	16,5	●	
SPC0034-0170-ALU	3,4	6	66	28	17,0	●	
SPC0035-0175-ALU	3,5	6	66	28	17,5	●	
SPC0037-0185-ALU	3,7	6	66	28	18,5	●	
SPC0040-0200-ALU	4,0	6	74	36	20,0	●	
SPC0042-0210-ALU	4,2	6	74	36	21,0	●	
SPC0045-0225-ALU	4,5	6	74	36	22,5	●	
SPC0047-0235-ALU	4,7	6	74	36	23,5	●	
SPC0050-0250-ALU	5,0	6	82	44	25,0	●	
SPC0051-0255-ALU	5,1	6	82	44	25,5	●	
SPC0052-0260-ALU	5,2	6	82	44	26,0	●	
SPC0055-0275-ALU	5,5	6	82	44	27,5	●	
SPC0056-0280-ALU	5,6	6	82	44	28,0	●	
SPC0060-0300-ALU	6,0	6	82	44	30,0	●	
SPC0061-0305-ALU	6,1	8	91	53	30,5	●	
SPC0068-0340-ALU	6,8	8	91	53	34,0	●	
SPC0070-0350-ALU	7,0	8	91	53	35,0	●	
SPC0071-0355-ALU	7,1	8	91	53	35,5	●	
SPC0072-0360-ALU	7,2	8	91	53	36,0	●	
SPC0073-0365-ALU	7,3	8	91	53	36,5	●	
SPC0075-0375-ALU	7,5	8	91	53	37,5	●	
SPC0080-0400-ALU	8,0	8	91	53	40,0	●	
SPC0081-0405-ALU	8,1	10	103	61	40,5	●	
SPC0082-0410-ALU	8,2	10	103	61	41,0	●	
SPC0085-0425-ALU	8,5	10	103	61	42,5	●	
SPC0088-0440-ALU	8,8	10	103	61	44,0	●	
SPC0090-0450-ALU	9,0	10	103	61	45,0	●	
SPC0093-0465-ALU	9,3	10	103	61	46,5	●	

							PG 24
							beschichtet coated revêtu
Schaft Shank Tige	D m7	d <sub>A</sub> h6	l	l <sub>2</sub>	l <sub>4</sub>	DLC	
SPC0098-0490-ALU	9,8	10	103	61	49,0	●	
SPC0100-0500-ALU	10,0	10	103	61	50,0	●	
SPC0101-0505-ALU	10,1	12	118	71	50,5	●	
SPC0105-0525-ALU	10,5	12	118	71	52,5	●	
SPC0110-0550-ALU	11,0	12	118	71	55,0	●	
SPC0120-0600-ALU	12,0	12	118	71	60,0	●	
SPC0130-0650-ALU	13,0	14	124	77	65,0	●	
SPC0140-0700-ALU	14,0	14	124	77	70,0	●	
SPC0150-0750-ALU	15,0	16	133	83	75,0	●	
SPC0160-0800-ALU	16,0	16	133	83	80,0	●	
SPC0170-0850-ALU	17,0	18	143	93	85,0	●	
SPC0180-0900-ALU	18,0	18	143	93	90,0	●	
SPC0190-0950-ALU	19,0	20	153	101	95,0	●	
SPC0200-1000-ALU	20,0	20	153	101	100,0	●	

P	
M	
K	
N	●
S	
H	

- **Hauptanwendung**  
Main application  
Application principale
- **Nebenanwendung**  
Secondary application  
Application secondaire







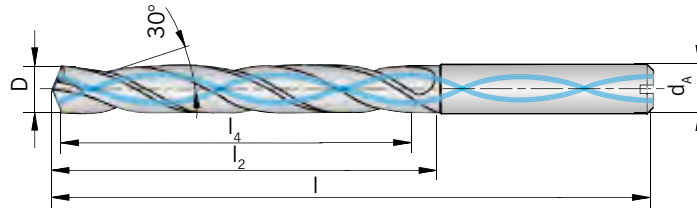

Solid carbide drills

Foret hélicoïdal-carbure monobloc

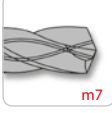
## Ausführung 5 x D für rostfreie Stähle / Execution 5 x D for stainless steel / Version 5 x D pour aciers inoxydables

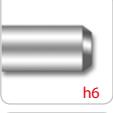
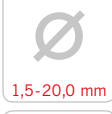
Mittellange Ausführung, mit Innenkühlung / Mid-length design, with through tool coolant / Version mi-longue avec refroidissement interne



-   450 - 488
-  m7  HAK
-  140°  h6
-  1,5-20,0 mm  30°
-  VA  5xD
-  **Feinstkorn**  
Ultra micro granulation  
Grain ultra fin

PG 24

beschichtet  
coated  
revêtu

Schaft Shank Tige	D m7	d <sub>A</sub> h6	l	l <sub>2</sub>	l <sub>4</sub>	TiAIN
SPC0015-0075-VA	1,50	3	55	16	7,5	●
SPC0016-0080-VA	1,60	3	55	16	8,0	●
SPC0017-0085-VA	1,70	3	55	16	8,5	●
SPC0018-0090-VA	1,80	3	55	16	9,0	●
SPC0019-0095-VA	1,90	3	55	16	9,5	●
SPC0020-0100-VA	2,00	4	57	21	10,0	●
SPC0021-0105-VA	2,10	4	57	21	10,5	●
SPC0022-0110-VA	2,20	4	57	21	11,0	●
SPC0023-0115-VA	2,30	4	57	21	11,5	●
SPC0024-0120-VA	2,40	4	57	21	12,0	●
SPC0025-0125-VA	2,50	4	57	21	12,5	●
SPC0026-0130-VA	2,60	4	57	21	13,0	●
SPC0027-0135-VA	2,70	4	57	21	13,5	●
SPC0028-0140-VA	2,80	4	57	21	14,0	●
SPC0029-0145-VA	2,90	4	57	21	14,5	●
SPC0030-0150-VA	3,00	6	66	28	15,0	●
SPC0031-0155-VA	3,10	6	66	28	15,5	●
SPC0032-0160-VA	3,20	6	66	28	16,0	●
SPC0033-0165-VA	3,30	6	66	28	16,5	●
SPC0034-0170-VA	3,40	6	66	28	17,0	●
SPC0035-0175-VA	3,50	6	66	28	17,5	●
SPC0036-0180-VA	3,60	6	66	28	18,0	●
SPC0037-0185-VA	3,70	6	66	28	18,5	●
SPC0038-0190-VA	3,80	6	74	36	19,0	●
SPC0039-0195-VA	3,90	6	74	36	19,5	●
SPC0040-0200-VA	4,00	6	74	36	20,0	●
SPC0041-0205-VA	4,10	6	74	36	20,5	●
SPC0042-0210-VA	4,20	6	74	36	21,0	●
SPC0043-0215-VA	4,30	6	74	36	21,5	●
SPC0044-0220-VA	4,40	6	74	36	22,0	●



							PG 24
							beschichtet coated revêtu
Schaft Shank Tige	D m7	d <sub>A</sub> h6	l	l <sub>2</sub>	l <sub>4</sub>	TiAIN	
SPC0045-0225-VA	4,50	6	74	36	22,5	●	
SPC0046-0230-VA	4,60	6	74	36	23,0	●	
SPC0047-0235-VA	4,70	6	74	36	23,5	●	
SPC0048-0240-VA	4,80	6	82	44	24,0	●	
SPC0049-0245-VA	4,90	6	82	44	24,5	●	
SPC0050-0250-VA	5,00	6	82	44	25,0	●	
SPC0051-0255-VA	5,10	6	82	44	25,5	●	
SPC0052-0260-VA	5,20	6	82	44	26,0	●	
SPC0053-0265-VA	5,30	6	82	44	26,5	●	
SPC0054-0270-VA	5,40	6	82	44	27,0	●	
SPC0055-0275-VA	5,50	6	82	44	27,5	●	
SPC0056-0280-VA	5,60	6	82	44	28,0	●	
SPC0057-0285-VA	5,70	6	82	44	28,5	●	
SPC0058-0290-VA	5,80	6	82	44	29,0	●	
SPC0059-0295-VA	5,90	6	82	44	29,5	●	
SPC0060-0300-VA	6,00	6	82	44	30,0	●	
SPC0061-0305-VA	6,10	8	91	53	30,5	●	
SPC0062-0310-VA	6,20	8	91	53	31,0	●	
SPC0063-0315-VA	6,30	8	91	53	31,5	●	
SPC0065-0325-VA	6,50	8	91	53	32,5	●	
SPC0066-0330-VA	6,60	8	91	53	33,0	●	
SPC0068-0340-VA	6,80	8	91	53	34,0	●	
SPC0069-0345-VA	6,90	8	91	53	34,5	●	
SPC0070-0350-VA	7,00	8	91	53	35,0	●	
SPC0071-0355-VA	7,10	8	91	53	35,5	●	
SPC0072-0360-VA	7,20	8	91	53	36,0	●	
SPC0074-0370-VA	7,40	8	91	53	37,0	●	
SPC0075-0375-VA	7,50	8	91	53	37,5	●	
SPC00765-0383-VA	7,65	8	91	53	38,3	●	
SPC0078-0390-VA	7,80	8	91	53	39,0	●	
SPC0080-0400-VA	8,00	8	91	53	40,0	●	
SPC0081-0405-VA	8,10	10	103	61	40,5	●	
SPC0082-0410-VA	8,20	10	103	61	41,0	●	
SPC0084-0420-VA	8,40	10	103	61	42,0	●	
SPC0085-0425-VA	8,50	10	103	61	42,5	●	
SPC0086-0430-VA	8,60	10	103	61	43,0	●	
SPC0087-0435-VA	8,70	10	103	61	43,5	●	
SPC0088-0440-VA	8,80	10	103	61	44,0	●	
SPC0089-0445-VA	8,90	10	103	61	44,5	●	
SPC0090-0450-VA	9,00	10	103	61	45,0	●	
SPC0091-0455-VA	9,10	10	103	61	45,5	●	
SPC0092-0460-VA	9,20	10	103	61	46,0	●	
SPC0094-0470-VA	9,40	10	103	61	47,0	●	
SPC0095-0475-VA	9,50	10	103	61	47,5	●	
SPC00955-0488-VA	9,55	10	103	61	48,8	●	
SPC0097-0485-VA	9,70	10	103	61	48,5	●	
SPC0098-0490-VA	9,80	10	103	61	49,0	●	
SPC0100-0500-VA	10,00	10	103	61	50,0	●	
SPC0101-0505-VA	10,10	12	118	71	50,5	●	
SPC0102-0510-VA	10,20	12	118	71	51,0	●	
SPC0103-0515-VA	10,30	12	118	71	51,5	●	
SPC0104-0520-VA	10,40	12	118	71	52,0	●	
SPC0105-0525-VA	10,50	12	118	71	52,5	●	
SPC0106-0530-VA	10,60	12	118	71	53,0	●	
SPC0108-0540-VA	10,80	12	118	71	54,0	●	
SPC0110-0550-VA	11,00	12	118	71	55,0	●	

							PG 24
							beschichtet coated revêtu
Schaft Shank Tige	D m7	d <sub>A</sub> h6	l	l <sub>2</sub>	l <sub>4</sub>	TiAIN	
SPC0117-0585-VA	11,70	12	118	71	58,5	●	
SPC0118-0590-VA	11,80	12	118	71	59,0	●	
SPC0120-0600-VA	12,00	12	118	71	60,0	●	
SPC0125-0625-VA	12,50	14	124	77	62,5	●	
SPC0130-0650-VA	13,00	14	124	77	65,0	●	
SPC0135-0675-VA	13,50	14	124	77	67,5	●	
SPC0140-0700-VA	14,00	14	124	77	70,0	●	
SPC0150-0750-VA	15,00	16	133	83	75,0	●	
SPC0155-0775-VA	15,50	16	133	83	77,5	●	
SPC0160-0800-VA	16,00	16	133	83	80,0	●	
SPC0165-0825-VA	16,50	18	143	93	82,5	●	
SPC0170-0850-VA	17,00	18	143	93	85,0	●	
SPC0180-0900-VA	18,00	18	143	93	90,0	●	
SPC0190-0950-VA	19,00	20	153	101	95,0	●	
SPC0200-1000-VA	20,00	20	153	101	100,0	●	

P	○
M	●
K	
N	
S	
H	

- **Hauptanwendung**  
Main application  
Application principale
- **Nebenanwendung**  
Secondary application  
Application secondaire

Solid carbide drills  
Foret hélicoïdal-carbure monobloc

## Ausführung 5 x D / Execution 5 x D / Version 5 x D

3 Schneiden, mittellange Ausführung, mit Innenkühlung / 3 flutes, mid-length design, with through tool coolant / 3 dents, version mi-longue avec refroidissement interne

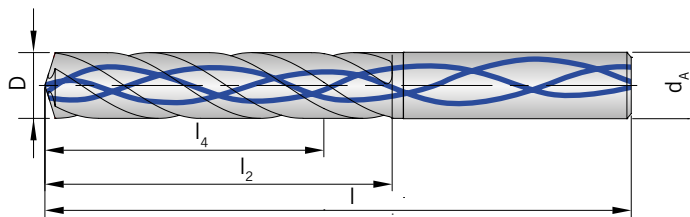
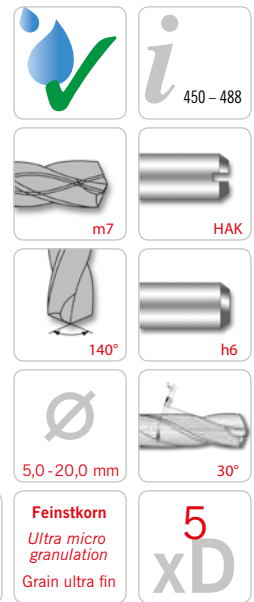

**N** NEU/NEW/NOUVEAU

							PG 24
							beschichtet coated revêtu
Schaft Shank Tige	D m7	d <sub>A</sub> h6	l	l <sub>2</sub>	l <sub>4</sub>	TiAIN	
SPC0500-0250-3S <b>N</b>	5,0	6	82	44	25,0	●	
SPC0510-0255-3S <b>N</b>	5,1	6	82	44	25,5	●	
SPC0520-0260-3S <b>N</b>	5,2	6	82	44	26,0	●	
SPC0530-0265-3S <b>N</b>	5,3	6	82	44	26,5	●	
SPC0540-0270-3S <b>N</b>	5,4	6	82	44	27,0	●	
SPC0550-0275-3S <b>N</b>	5,5	6	82	44	27,5	●	
SPC0560-0280-3S <b>N</b>	5,6	6	82	44	28,0	●	
SPC0570-0285-3S <b>N</b>	5,7	6	82	44	28,5	●	
SPC0580-0290-3S <b>N</b>	5,8	6	82	44	29,0	●	
SPC0590-0295-3S <b>N</b>	5,9	6	82	44	29,5	●	
SPC0600-0300-3S <b>N</b>	6,0	6	82	44	30,0	●	
SPC0610-0305-3S <b>N</b>	6,1	8	91	53	30,5	●	
SPC0620-0310-3S <b>N</b>	6,2	8	91	53	31,0	●	
SPC0630-0315-3S <b>N</b>	6,3	8	91	53	31,5	●	
SPC0640-0320-3S <b>N</b>	6,4	8	91	53	32,0	●	
SPC0650-0325-3S <b>N</b>	6,5	8	91	53	32,5	●	
SPC0660-0330-3S <b>N</b>	6,6	8	91	53	33,0	●	
SPC0670-0335-3S <b>N</b>	6,7	8	91	53	33,5	●	
SPC0680-0340-3S <b>N</b>	6,8	8	91	53	34,0	●	
SPC0690-0345-3S <b>N</b>	6,9	8	91	53	34,5	●	
SPC0700-0350-3S <b>N</b>	7,0	8	91	53	35,0	●	
SPC0710-0355-3S <b>N</b>	7,1	8	91	53	35,5	●	
SPC0720-0360-3S <b>N</b>	7,2	8	91	53	36,0	●	
SPC0730-0365-3S <b>N</b>	7,3	8	91	53	36,5	●	
SPC0740-0370-3S <b>N</b>	7,4	8	91	53	37,0	●	
SPC0750-0375-3S <b>N</b>	7,5	8	91	53	37,5	●	
SPC0760-0380-3S <b>N</b>	7,6	8	91	53	38,0	●	

							PG 24
							beschichtet coated revêtu
Schaft Shank Tige	D m7	d <sub>A</sub> h6	l	l <sub>2</sub>	l <sub>4</sub>	TiAIN	
SPC0770-0385-3S	7,7	8	91	53	38,5	●	
SPC0780-0390-3S	7,8	8	91	53	39,0	●	
SPC0790-0395-3S	7,9	8	91	53	39,5	●	
SPC0800-0400-3S	8,0	8	91	53	40,0	●	
SPC0810-0405-3S	8,1	10	103	61	40,5	●	
SPC0820-0410-3S	8,2	10	103	61	41,0	●	
SPC0830-0415-3S	8,3	10	103	61	41,5	●	
SPC0840-0420-3S	8,4	10	103	61	42,0	●	
SPC0850-0425-3S	8,5	10	103	61	42,5	●	
SPC0860-0430-3S	8,6	10	103	61	43,0	●	
SPC0860-0430-3S	8,7	10	103	61	43,5	●	
SPC0880-0440-3S	8,8	10	103	61	44,0	●	
SPC0890-0445-3S	8,9	10	103	61	44,5	●	
SPC0900-0450-3S	9,0	10	103	61	45,0	●	
SPC0910-0455-3S	9,1	10	103	61	45,5	●	
SPC0920-0460-3S	9,2	10	103	61	46,0	●	
SPC0930-0465-3S	9,3	10	103	61	46,5	●	
SPC0940-0470-3S	9,4	10	103	61	47,0	●	
SPC0950-0475-3S	9,5	10	103	61	47,5	●	
SPC0960-0480-3S	9,6	10	103	61	48,0	●	
SPC0970-0485-3S	9,7	10	103	61	48,5	●	
SPC0980-0490-3S	9,8	10	103	61	49,0	●	
SPC0990-0495-3S	9,9	10	103	61	49,5	●	
SPC1000-0500-3S	10,0	10	103	61	50,0	●	
SPC1010-0505-3S	10,1	12	118	71	50,5	●	
SPC1020-0510-3S	10,2	12	118	71	51,0	●	
SPC1030-0515-3S	10,3	12	118	71	51,5	●	
SPC1040-0520-3S	10,4	12	118	71	52,0	●	
SPC1050-0525-3S	10,5	12	118	71	52,5	●	
SPC1060-0530-3S	10,6	12	118	71	53,0	●	
SPC1070-0535-3S	10,7	12	118	71	53,5	●	
SPC1080-0540-3S	10,8	12	118	71	54,0	●	
SPC1090-0545-3S	10,9	12	118	71	54,5	●	
SPC1100-0550-3S	11,0	12	118	71	55,0	●	
SPC1110-0555-3S	11,1	12	118	71	55,5	●	
SPC1120-0560-3S	11,2	12	118	71	56,0	●	
SPC1130-0565-3S	11,3	12	118	71	56,5	●	
SPC1140-0570-3S	11,4	12	118	71	57,0	●	
SPC1150-0575-3S	11,5	12	118	71	57,5	●	
SPC1160-0580-3S	11,6	12	118	71	58,0	●	
SPC1170-0585-3S	11,7	12	118	71	58,5	●	
SPC1180-0590-3S	11,8	12	118	71	59,0	●	
SPC1190-0595-3S	11,9	12	118	71	59,5	●	
SPC1200-0600-3S	12,0	12	118	71	60,0	●	
SPC1250-0625-3S	12,5	14	124	77	62,5	●	
SPC1300-0650-3S	13,0	14	124	77	65,0	●	
SPC1350-0675-3S	13,5	14	124	77	67,5	●	
SPC1400-0700-3S	14,0	14	124	77	70,0	●	
SPC1450-0725-3S	14,5	16	133	83	72,5	●	
SPC1500-0750-3S	15,0	16	133	83	75,0	●	
SPC1550-0775-3S	15,5	16	133	83	77,5	●	
SPC1600-0800-3S	16,0	16	133	83	80,0	●	

Solid carbide drills

Foret hélicoïdal-carbure monobloc

							PG 24
							beschichtet coated revêtu
Schaft Shank Tige	D m7	d <sub>A</sub> h6	l	l <sub>2</sub>	l <sub>4</sub>	TiAIN	
SPC1650-0825-3S <b>N</b>	16,5	18	143	93	82,5	●	
SPC1700-0850-3S <b>N</b>	17,0	18	143	93	85,0	●	
SPC1750-0875-3S <b>N</b>	17,5	18	143	93	87,5	●	
SPC1800-0900-3S <b>N</b>	18,0	18	143	93	90,0	●	
SPC1850-0925-3S <b>N</b>	18,5	20	153	101	92,5	●	
SPC1900-0950-3S <b>N</b>	19,0	20	153	101	95,0	●	
SPC1950-0975-3S <b>N</b>	19,5	20	153	101	97,5	●	
SPC2000-1000-3S <b>N</b>	20,0	20	153	101	100,0	●	

P	●
M	○
K	○
N	
S	
H	

- **Hauptanwendung**  
Main application  
Application principale
- **Nebenanwendung**  
Secondary application  
Application secondaire

Solid carbide drills

Foret hélicoïdal-carbure monobloc

## Mittellange Ausführung für gehärtete Stähle / Mid-length execution for hardened steel / Version mi-longue pour aciers trempés

Mittellange Ausführung, ohne Innenkühlung / Mid-length design, without through tool coolant / Version mi-longue, sans refroidissement interne

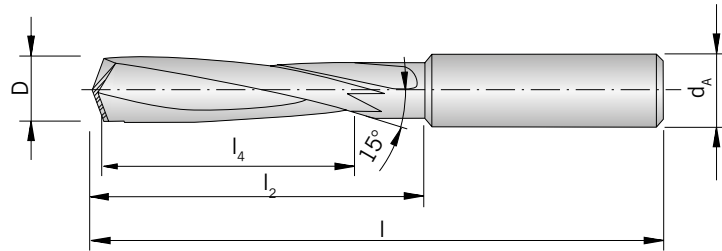

- 
- 450 - 488
- m7
- HA
- 140°
- h6
- 3,0 - 14,0 mm
- 15°
- Feinstkorn  
Ultra micro granulation  
Grain ultra fin
- H

							PG 24
							beschichtet coated revêtu
Schaft Shank Tige	D	d <sub>A</sub>	l	l <sub>2</sub>	l <sub>4</sub>	TiAlN	
SP0030-0150-H	3,0	3	46	16	15,0	●	
SP0033-0165-H	3,3	4	48	18	16,5	●	
SP0034-0170-H	3,4	4	50	20	17,0	●	
SP0035-0175-H	3,5	4	50	20	17,5	●	
SP0040-0200-H	4,0	4	52	22	20,0	●	
SP0042-0210-H	4,2	6	65	25	21,0	●	
SP0043-0215-H	4,3	6	68	28	21,5	●	
SP0044-0220-H	4,4	6	68	28	22,0	●	
SP0045-0225-H	4,5	6	68	28	22,5	●	
SP0050-0250-H	5,0	6	72	32	25,0	●	
SP0051-0255-H	5,1	6	72	32	25,5	●	
SP0052-0260-H	5,2	6	72	32	26,0	●	
SP0055-0275-H	5,5	6	75	35	27,5	●	
SP0060-0300-H	6,0	6	75	35	30,0	●	
SP0065-0325-H	6,5	8	80	40	32,5	●	
SP0068-0340-H	6,8	8	85	45	34,0	●	
SP0069-0345-H	6,9	8	85	45	34,5	●	
SP0070-0350-H	7,0	8	85	45	35,0	●	
SP0075-0375-H	7,5	8	85	45	37,5	●	
SP0080-0400-H	8,0	8	98	50	40,0	●	
SP0085-0425-H	8,5	10	98	50	42,5	●	
SP0086-0430-H	8,6	10	105	57	43,0	●	
SP0088-0440-H	8,8	10	105	57	44,0	●	
SP0090-0450-H	9,0	10	105	57	45,0	●	
SP0100-0500-H	10,0	10	111	63	50,0	●	
SP0102-0510-H	10,2	12	111	63	51,0	●	

Solid carbide drills

Foret hélicoïdal-carbure monobloc

							PG 24
							beschichtet coated revêtu
Schaft Shank Tige	D	d <sub>A</sub>	l	l <sub>2</sub>	l <sub>4</sub>	TiAIN	
SP0103-0515-H	10,3	12	111	63	51,5	●	
SP0110-0550-H	11,0	12	119	71	55,0	●	
SP0120-0600-H	12,0	12	119	71	60,0	●	
SP0140-0700-H	14,0	14	125	71	70,0	●	

P	
M	
K	
N	
S	
H	●

- **Hauptanwendung**  
Main application  
Application principale
- **Nebenanwendung**  
Secondary application  
Application secondaire

Solid carbide drills

Foret hélicoïdal-carbure monobloc

## Ausführung 7 x D / Execution 7 x D / Version 7 x D

Lange Ausführung, ohne Innenkühlung / Long design, without through tool coolant /  
Version longue, sans refroidissement interne

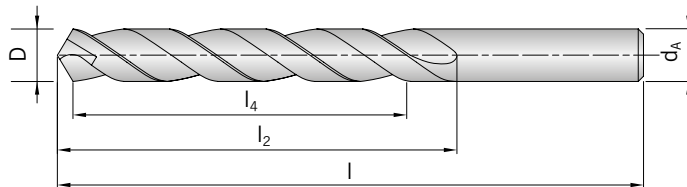
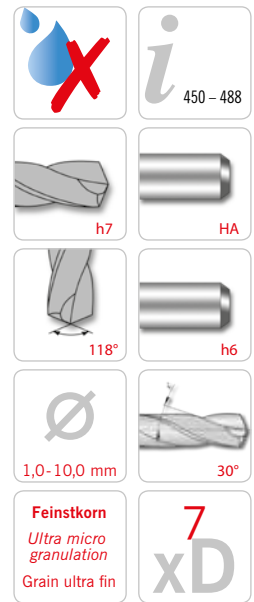

							PG 24
							unbeschichtet uncoated non-révetu
Schaft Shank Tige	D h7	d <sub>A</sub> h6	l	l <sub>2</sub>	l <sub>4</sub>	VHM/FK	
SP0010-0070	1,0	1,0	34	12	7,0	●	
SP0011-0077	1,1	1,1	36	14	7,7	●	
SP0012-0084	1,2	1,2	38	16	8,4	●	
SP0013-0091	1,3	1,3	38	16	9,1	●	
SP0014-0098	1,4	1,4	40	18	9,8	●	
SP0015-0105	1,5	1,5	40	18	10,5	●	
SP0016-0112	1,6	1,6	43	20	11,2	●	
SP0017-0119	1,7	1,7	43	20	11,9	●	
SP0018-0126	1,8	1,8	46	22	12,6	●	
SP0019-0133	1,9	1,9	46	22	13,3	●	
SP0020-0140	2,0	2,0	49	24	14,0	●	
SP0021-0147	2,1	2,1	49	24	14,7	●	
SP0022-0154	2,2	2,2	53	27	15,4	●	
SP0023-0161	2,3	2,3	53	27	16,1	●	
SP0024-0168	2,4	2,4	57	30	16,8	●	
SP0025-0175	2,5	2,5	57	30	17,5	●	
SP0026-0182	2,6	2,6	57	30	18,2	●	
SP0027-0189	2,7	2,7	61	33	18,9	●	
SP0028-0196	2,8	2,8	61	33	19,6	●	
SP0029-0203	2,9	2,9	61	33	20,3	●	
SP0030-0210	3,0	3,0	61	33	21,0	●	
SP0031-0217	3,1	3,1	65	36	21,7	●	
SP0032-0224	3,2	3,2	65	36	22,4	●	
SP0033-0231	3,3	3,3	65	36	23,1	●	
SP0034-0238	3,4	3,4	70	39	23,8	●	
SP0035-0245	3,5	3,5	70	39	24,5	●	
SP0036-0252	3,6	3,6	70	39	25,2	●	
SP0037-0259	3,7	3,7	70	39	25,9	●	
SP0038-0266	3,8	3,8	75	43	26,6	●	
SP0039-0273	3,9	3,9	75	43	27,3	●	
SP0040-0280	4,0	4,0	75	43	28,0	●	
SP0041-0287	4,1	4,1	75	43	28,7	●	



							PG 24
							unbeschichtet uncoated non-revêtu
Schaft Shank Tige	D h7	d <sub>A</sub> h6	l	l <sub>2</sub>	l <sub>4</sub>	VHM/FK	
SP0042-0294	4,2	4,2	75	43	29,4	●	
SP0043-0301	4,3	4,3	80	47	30,1	●	
SP0044-0308	4,4	4,4	80	47	30,8	●	
SP0045-0315	4,5	4,5	80	47	31,5	●	
SP0046-0322	4,6	4,6	80	47	32,2	●	
SP0047-0329	4,7	4,7	80	47	32,9	●	
SP0048-0336	4,8	4,8	86	52	33,6	●	
SP0050-0350	5,0	5,0	86	52	35,0	●	
SP0051-0357	5,1	5,1	86	52	35,7	●	
SP0053-0371	5,3	5,3	86	52	37,1	●	
SP0055-0385	5,5	5,5	93	57	38,5	●	
SP0056-0392	5,6	5,6	93	57	39,2	●	
SP0058-0406	5,8	5,8	93	57	40,6	●	
SP0060-0420	6,0	6,0	93	57	42,0	●	
SP0063-0441	6,3	6,3	101	63	44,1	●	
SP0065-0455	6,5	6,5	101	63	45,5	●	
SP0068-0476	6,8	6,8	109	69	47,6	●	
SP0070-0490	7,0	7,0	109	69	49,0	●	
SP0080-0560	8,0	8,0	117	75	56,0	●	
SP0085-0595	8,5	8,5	117	75	59,5	●	
SP0100-0700	10,0	10,0	133	87	70,0	●	

P	●
M	○
K	○
N	
S	
H	

● **Hauptanwendung**  
Main application  
Application principale

○ **Nebenanwendung**  
Secondary application  
Application secondaire

Solid carbide drills

Foret hélicoïdal-carbure monobloc

## Ausführung 7 x D / Execution 7 x D / Version 7 x D

Lange Ausführung, ohne Innenkühlung / Long design, without through tool coolant /  
Version longue, sans refroidissement interne

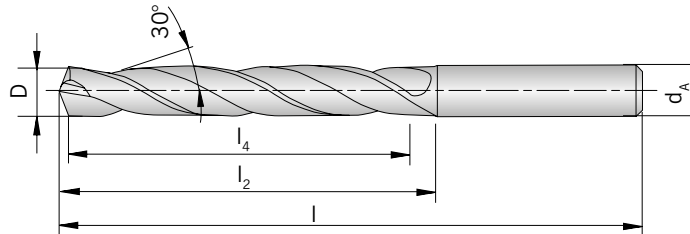
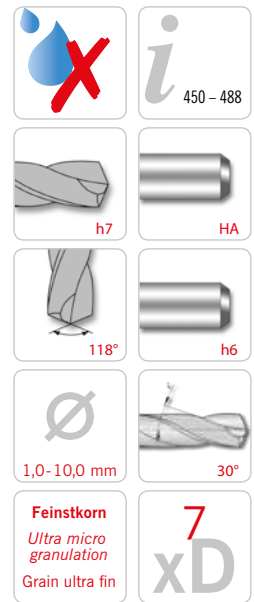

							PG 24
							beschichtet coated revêtu
Schaft Shank Tige	D h7	d <sub>A</sub> h6	l	l <sub>2</sub>	l <sub>4</sub>	TiAIN	
SP0010-0070	1,0	1,0	34	12	7,0	●	
SP0011-0077	1,1	1,1	36	14	7,7	●	
SP0012-0084	1,2	1,2	38	16	8,4	●	
SP0013-0091	1,3	1,3	38	16	9,1	●	
SP0014-0098	1,4	1,4	40	18	9,8	●	
SP0015-0105	1,5	1,5	40	18	10,5	●	
SP0016-0112	1,6	1,6	43	20	11,2	●	
SP0017-0119	1,7	1,7	43	20	11,9	●	
SP0018-0126	1,8	1,8	46	22	12,6	●	
SP0019-0133	1,9	1,9	46	22	13,3	●	
SP0020-0140	2,0	2,0	49	24	14,0	●	
SP0021-0147	2,1	2,1	49	24	14,7	●	
SP0022-0154	2,2	2,2	53	27	15,4	●	
SP0023-0161	2,3	2,3	53	27	16,1	●	
SP0024-0168	2,4	2,4	57	30	16,8	●	
SP0025-0175	2,5	2,5	57	30	17,5	●	
SP0026-0182	2,6	2,6	57	30	18,2	●	
SP0027-0189	2,7	2,7	61	33	18,9	●	
SP0028-0196	2,8	2,8	61	33	19,6	●	
SP0029-0203	2,9	2,9	61	33	20,3	●	
SP0030-0210	3,0	3,0	61	33	21,0	●	
SP0031-0217	3,1	3,1	65	36	21,7	●	
SP0032-0224	3,2	3,2	65	36	22,4	●	
SP0033-0231	3,3	3,3	65	36	23,1	●	
SP0034-0238	3,4	3,4	70	39	23,8	●	
SP0035-0245	3,5	3,5	70	39	24,5	●	
SP0036-0252	3,6	3,6	70	39	25,2	●	
SP0037-0259	3,7	3,7	70	39	25,9	●	
SP0038-0266	3,8	3,8	75	43	26,6	●	
SP0039-0273	3,9	3,9	75	43	27,3	●	
SP0040-0280	4,0	4,0	75	43	28,0	●	
SP0041-0287	4,1	4,1	75	43	28,7	●	

								PG 24
								beschichtet coated revêtu
Schaft Shank Tige	D h7	d <sub>A</sub> h6	l	l <sub>2</sub>	l <sub>4</sub>	TiAIN		
SP0042-0294	4,2	4,2	75	43	29,4	●		
SP0043-0301	4,3	4,3	80	47	30,1	●		
SP0044-0308	4,4	4,4	80	47	30,8	●		
SP0045-0315	4,5	4,5	80	47	31,5	●		
SP0046-0322	4,6	4,6	80	47	32,2	●		
SP0047-0329	4,7	4,7	80	47	32,9	●		
SP0048-0336	4,8	4,8	86	52	33,6	●		
SP0050-0350	5,0	5,0	86	52	35,0	●		
SP0051-0357	5,1	5,1	86	52	35,7	●		
SP0052-0364	5,2	5,2	86	52	36,4	●		
SP0053-0371	5,3	5,3	86	52	37,1	●		
SP0055-0385	5,5	5,5	93	57	38,5	●		
SP0058-0406	5,8	5,8	93	57	40,6	●		
SP0060-0420	6,0	6,0	93	57	42,0	●		
SP0061-0427	6,1	6,1	101	63	42,7	●		
SP0063-0441	6,3	6,3	101	63	44,1	●		
SP0064-0448	6,4	6,4	101	63	44,8	●		
SP0065-0455	6,5	6,5	101	63	45,5	●		
SP0068-0476	6,8	6,8	109	69	47,6	●		
SP0070-0490	7,0	7,0	109	69	49,0	●		
SP0080-0560	8,0	8,0	117	75	56,0	●		
SP0085-0595	8,5	8,5	117	75	59,5	●		
SP0100-0700	10,0	10,0	133	87	70,0	●		

P	●
M	○
K	○
N	
S	
H	

● **Hauptanwendung**  
Main application  
Application principale

○ **Nebenanwendung**  
Secondary application  
Application secondaire

Powder metal drills  
Foret hélicoïdal-PM-HSS

## Ausführung 7 x D Pulvermetallurgisches HSS / Execution 7 x D powder metal drill / Version 7 x D poudre métallurgique HSS

Lange Ausführung, ohne Innenkühlung / Long design, without through tool coolant / Version longue, sans refroidissement interne

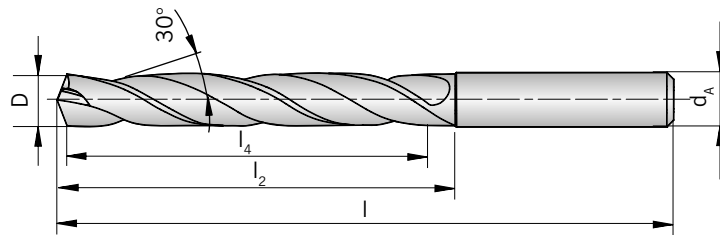
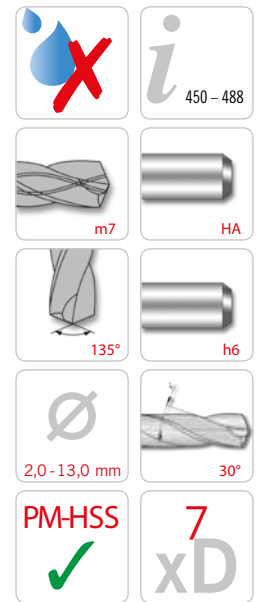

							PG 24
							beschichtet coated revêtu
Schaft Shank Tige	D m7	d <sub>A</sub> h6	l	l <sub>2</sub>	l <sub>4</sub>	TiAlN	
SP0020-0140-PM	2,0	3	56	24	14,0	●	
SP0021-0147-PM	2,1	3	56	24	14,7	●	
SP0022-0154-PM	2,2	3	56	25	15,4	●	
SP0024-0168-PM	2,4	3	61	30	16,8	●	
SP0025-0175-PM	2,5	3	61	30	17,5	●	
SP0027-0189-PM	2,7	3	64	33	18,9	●	
SP0028-0196-PM	2,8	3	64	33	19,6	●	
SP0030-0210-PM	3,0	3	64	33	21,0	●	
SP0031-0217-PM	3,1	4	68	36	21,7	●	
SP0032-0224-PM	3,2	4	68	36	22,4	●	
SP0033-0231-PM	3,3	4	68	36	23,1	●	
SP0034-0238-PM	3,4	4	71	39	23,8	●	
SP0035-0245-PM	3,5	4	71	39	24,5	●	
SP0037-0259-PM	3,7	4	71	39	25,9	●	
SP0039-0273-PM	3,9	4	75	43	27,3	●	
SP0040-0280-PM	4,0	4	75	43	28,0	●	
SP0041-0287-PM	4,1	6	85	43	28,7	●	
SP0042-0294-PM	4,2	6	85	43	29,4	●	
SP0045-0315-PM	4,5	6	89	47	31,5	●	
SP0048-0336-PM	4,8	6	94	52	33,6	●	
SP0050-0350-PM	5,0	6	94	52	35,0	●	
SP0051-0357-PM	5,1	6	94	52	35,7	●	
SP0052-0364-PM	5,2	6	94	52	36,4	●	
SP0055-0385-PM	5,5	6	99	57	38,5	●	
SP0057-0399-PM	5,7	6	99	57	39,9	●	
SP0060-0420-PM	6,0	6	99	57	42,0	●	
SP0061-0427-PM	6,1	8	107	63	42,7	●	
SP0062-0434-PM	6,2	8	107	63	43,4	●	
SP0065-0455-PM	6,5	8	107	63	45,5	●	
SP0068-0476-PM	6,8	8	113	69	47,6	●	

							PG 24
							beschichtet coated revêtu
Schaft Shank Tige	D m7	d <sub>A</sub> h6	l	l <sub>2</sub>	l <sub>4</sub>	TiAIN	
SP0069-0483-PM	6,9	8	113	69	48,3	●	
SP0070-0490-PM	7,0	8	113	69	49,0	●	
SP0071-0497-PM	7,1	8	113	69	49,7	●	
SP0074-0518-PM	7,4	8	113	69	51,8	●	
SP0076-0532-PM	7,6	8	119	75	53,2	●	
SP0078-0546-PM	7,8	8	119	75	54,6	●	
SP0080-0560-PM	8,0	8	119	75	56,0	●	
SP0083-0581-PM	8,3	10	125	75	58,1	●	
SP0085-0595-PM	8,5	10	125	75	59,5	●	
SP0090-0630-PM	9,0	10	131	81	63,0	●	
SP0099-0693-PM	9,9	10	137	87	69,3	●	
SP0100-0700-PM	10,0	10	137	87	70,0	●	
SP0102-0714-PM	10,2	12	144	87	71,4	●	
SP0103-0721-PM	10,3	12	144	87	72,1	●	
SP0105-0735-PM	10,5	12	144	87	73,5	●	
SP0110-0770-PM	11,0	12	151	94	77,0	●	
SP0114-0798-PM	11,4	12	151	94	79,8	●	
SP0120-0840-PM	12,0	12	158	101	84,0	●	
SP0121-0847-PM	12,1	12	158	101	84,7	●	
SP0130-0910-PM	13,0	12	158	101	91,0	●	

P	●
M	○
K	○
N	
S	
H	

● Hauptanwendung  
Main application  
Application principale

○ Nebenanwendung  
Secondary application  
Application secondaire

Solid carbide drills

Foret hélicoïdal-carbure monobloc

## Ausführung 8 x D / Execution 8 x D / Version 8 x D

Lange Ausführung, mit Innenkühlung / Long design, with through tool coolant / Version longue, avec refroidissement interne

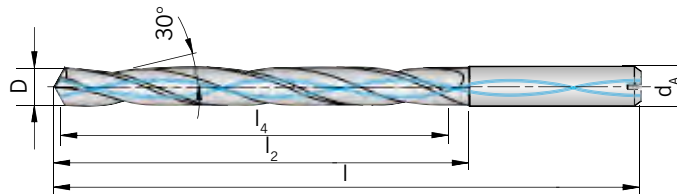
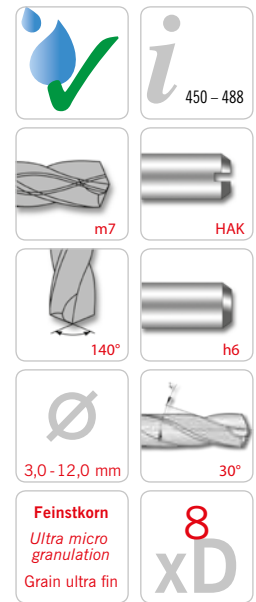

							PG 24
							beschichtet coated revêtu
Schaft Shank Tige	D m7	d <sub>A</sub> h6	l	l <sub>2</sub>	l <sub>4</sub>	TiAIN	
SPC0030-0240	3,0	6	72	34	24,0	●	
SPC0031-0248	3,1	6	72	34	24,8	●	
SPC0032-0256	3,2	6	72	34	25,6	●	
SPC0033-0264	3,3	6	72	34	26,4	●	
SPC0034-0272	3,4	6	72	34	27,2	●	
SPC0035-0280	3,5	6	72	34	28,0	●	
SPC0036-0288	3,6	6	72	34	28,8	●	
SPC0037-0296	3,7	6	72	34	29,6	●	
SPC0038-0304	3,8	6	81	43	30,4	●	
SPC0039-0312	3,9	6	81	43	31,2	●	
SPC0040-0320	4,0	6	81	43	32,0	●	
SPC0041-0328	4,1	6	81	43	32,8	●	
SPC0042-0336	4,2	6	81	43	33,6	●	
SPC0043-0344	4,3	6	81	43	34,4	●	
SPC0044-0352	4,4	6	81	43	35,2	●	
SPC0045-0360	4,5	6	81	43	36,0	●	
SPC0046-0368	4,6	6	81	43	36,8	●	
SPC0047-0376	4,7	6	81	43	37,6	●	
SPC0048-0384	4,8	6	95	57	38,4	●	
SPC0050-0400	5,0	6	95	57	40,0	●	
SPC0051-0408	5,1	6	95	57	40,8	●	
SPC0052-0416	5,2	6	95	57	41,6	●	
SPC0053-0424	5,3	6	95	57	42,4	●	
SPC0054-0432	5,4	6	95	57	43,2	●	
SPC0055-0440	5,5	6	95	57	44,0	●	
SPC0056-0448	5,6	6	95	57	44,8	●	
SPC0057-0456	5,7	6	95	57	45,6	●	
SPC0058-0464	5,8	6	95	57	46,4	●	
SPC0059-0472	5,9	6	95	57	47,2	●	
SPC0060-0480	6,0	6	95	57	48,0	●	
SPC0061-0488	6,1	8	114	76	48,8	●	
SPC0062-0496	6,2	8	114	76	49,6	●	

							PG 24
							beschichtet coated revêtu
Schaft Shank Tige	D m7	d <sub>A</sub> h6	l	l <sub>2</sub>	l <sub>4</sub>	TiAIN	
SPC0063-0504	6,3	8	114	76	50,4	●	
SPC0065-0520	6,5	8	114	76	52,0	●	
SPC0066-0528	6,6	8	114	76	52,8	●	
SPC0067-0536	6,7	8	114	76	53,6	●	
SPC0068-0544	6,8	8	114	76	54,4	●	
SPC0069-0552	6,9	8	114	76	55,2	●	
SPC0070-0560	7,0	8	114	76	56,0	●	
SPC0071-0568	7,1	8	114	76	56,8	●	
SPC0072-0576	7,2	8	114	76	57,6	●	
SPC0074-0592	7,4	8	114	76	59,2	●	
SPC0075-0600	7,5	8	114	76	60,0	●	
SPC0076-0608	7,6	8	114	76	60,8	●	
SPC0077-0616	7,7	8	114	76	61,6	●	
SPC0078-0624	7,8	8	114	76	62,4	●	
SPC0079-0632	7,9	8	114	76	63,2	●	
SPC0080-0640	8,0	8	114	76	64,0	●	
SPC0081-0648	8,1	10	142	95	64,8	●	
SPC0082-0656	8,2	10	142	95	65,6	●	
SPC0083-0664	8,3	10	142	95	66,4	●	
SPC0085-0680	8,5	10	142	95	68,0	●	
SPC0086-0688	8,6	10	142	95	68,8	●	
SPC0087-0696	8,7	10	142	95	69,6	●	
SPC0088-0704	8,8	10	142	95	70,4	●	
SPC0089-0712	8,9	10	142	95	71,2	●	
SPC0090-0720	9,0	10	142	95	72,0	●	
SPC0091-0728	9,1	10	142	95	72,8	●	
SPC0093-0744	9,3	10	142	95	74,4	●	
SPC0094-0752	9,4	10	142	95	75,2	●	
SPC0095-0760	9,5	10	142	95	76,0	●	
SPC0096-0768	9,6	10	142	95	76,8	●	
SPC0097-0776	9,7	10	142	95	77,6	●	
SPC0098-0784	9,8	10	142	95	78,4	●	
SPC0100-0800	10,0	10	142	95	80,0	●	
SPC0101-0808	10,1	12	162	114	80,8	●	
SPC0102-0816	10,2	12	162	114	81,6	●	
SPC0103-0824	10,3	12	162	114	82,4	●	
SPC0104-0832	10,4	12	162	114	83,2	●	
SPC0105-0840	10,5	12	162	114	84,0	●	
SPC0108-0864	10,8	12	162	114	86,4	●	
SPC0110-0880	11,0	12	162	114	88,0	●	
SPC0113-0904	11,3	12	162	114	90,4	●	
SPC0115-0920	11,5	12	162	114	92,0	●	
SPC0116-0928	11,6	12	162	114	92,8	●	
SPC0118-0944	11,8	12	162	114	94,4	●	
SPC0120-0960	12,0	12	162	114	96,0	●	

P	●
M	○
K	○
N	
S	
H	

● Hauptanwendung  
Main application  
Application principale

○ Nebenanwendung  
Secondary application  
Application secondaire







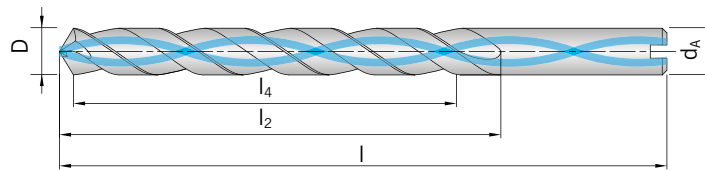

Solid carbide drills

Foret hélicoïdal-carbure monobloc

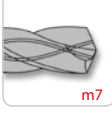
## Ausführung 8 x D für Aluminium / Execution 8 x D for aluminium / Version 8 x D pour aluminium

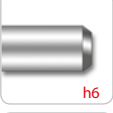
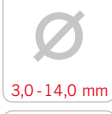
Lange Ausführung, mit Innenkühlung, Diamant beschichtet / Long design, with through tool coolant, diamond coated / Version longue, avec refroidissement interne, revêtement diamanté



-  
-  
-  
-  
-  
- 

							PG 24
							beschichtet coated revêtu
Schaft Shank Tige	D m7	d <sub>A</sub> h6	l	l <sub>2</sub>	l <sub>4</sub>	DLC	
SPC0030-0240-ALU	3,0	6	72	34	24,0	●	
SPC0031-0248-ALU	3,1	6	72	34	24,8	●	
SPC0038-0304-ALU	3,8	6	81	43	30,4	●	
SPC0040-0320-ALU	4,0	6	81	43	32,0	●	
SPC0042-0336-ALU	4,2	6	81	43	33,6	●	
SPC0043-0344-ALU	4,3	6	81	43	34,4	●	
SPC0050-0400-ALU	5,0	6	95	57	40,0	●	
SPC0052-0416-ALU	5,2	6	95	57	41,6	●	
SPC0060-0480-ALU	6,0	6	95	57	48,0	●	
SPC0061-0488-ALU	6,1	8	114	76	48,8	●	
SPC0065-0520-ALU	6,5	8	114	76	52,0	●	
SPC0066-0528-ALU	6,6	8	114	76	52,8	●	
SPC0068-0544-ALU	6,8	8	114	76	54,4	●	
SPC0070-0560-ALU	7,0	8	114	76	56,0	●	
SPC0080-0640-ALU	8,0	8	114	76	64,0	●	
SPC0081-0648-ALU	8,1	10	142	95	64,8	●	
SPC0085-0680-ALU	8,5	10	142	95	68,0	●	
SPC0090-0720-ALU	9,0	10	142	95	72,0	●	
SPC0095-0760-ALU	9,5	10	142	95	76,0	●	
SPC0100-0800-ALU	10,0	10	142	95	80,0	●	
SPC0110-0880-ALU	11,0	12	162	114	88,0	●	
SPC0120-0960-ALU	12,0	12	162	114	96,0	●	



Solid carbide drills

Foret hélicoïdal-carbure monobloc

							PG 24
							beschichtet coated revêtu
Schaft Shank Tige	D m7	d <sub>A</sub> h6	l	l <sub>2</sub>	l <sub>4</sub>	DLC	
SPC0130-1040-ALU	13,0	14	178	133	104,0	●	
SPC0140-1120-ALU	14,0	14	178	133	112,0	●	

P	
M	
K	
N	●
S	
H	







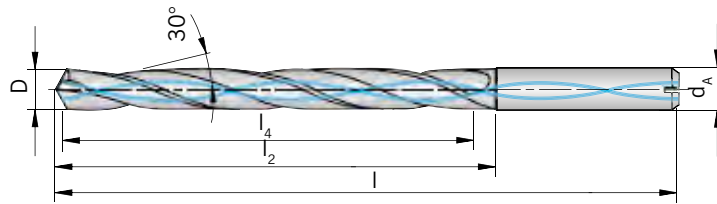

- **Hauptanwendung**  
Main application  
Application principale
- **Nebenanwendung**  
Secondary application  
Application secondaire

Solid carbide drills  
Foret hélicoïdal-carbure monobloc

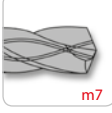
## Ausführung 8 x D für rostfreie Stähle / Execution 8 x D for stainless steel / Version 8 x D pour aciers inoxydables

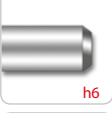
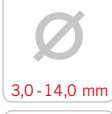
Lange Ausführung, mit Innenkühlung / Long design, with through tool coolant / Version longue, avec refroidissement interne



- 
- 
- 
- 
- 
- 
- 
- 
- 
- 
- 

							PG 24
							beschichtet coated revêtu
Schaft Shank Tige	D m7	d <sub>A</sub> h6	l	l <sub>2</sub>	l <sub>4</sub>	TiAIN	
SPC0030-0240-VA	3,0	6	72	34	24,0	●	
SPC0031-0248-VA	3,1	6	72	34	24,8	●	
SPC0032-0256-VA	3,2	6	72	34	25,6	●	
SPC0034-0272-VA	3,4	6	72	34	27,2	●	
SPC0035-0280-VA	3,5	6	72	34	28,0	●	
SPC0038-0304-VA	3,8	6	81	43	30,4	●	
SPC0039-0312-VA	3,9	6	81	43	31,2	●	
SPC0040-0320-VA	4,0	6	81	43	32,0	●	
SPC0042-0336-VA	4,2	6	81	43	33,6	●	
SPC0045-0360-VA	4,5	6	81	43	36,0	●	
SPC0048-0384-VA	4,8	6	95	57	38,4	●	
SPC0049-0392-VA	4,9	6	95	57	39,2	●	
SPC0050-0400-VA	5,0	6	95	57	40,0	●	
SPC0051-0408-VA	5,1	6	95	57	40,8	●	
SPC0053-0424-VA	5,3	6	95	57	42,4	●	
SPC0055-0440-VA	5,5	6	95	57	44,0	●	
SPC0056-0448-VA	5,6	6	95	57	44,8	●	
SPC0057-0456-VA	5,7	6	95	57	45,6	●	
SPC0058-0464-VA	5,8	6	95	57	46,4	●	
SPC0060-0480-VA	6,0	6	95	57	48,0	●	
SPC0061-0488-VA	6,1	8	114	76	48,8	●	
SPC0064-0512-VA	6,4	8	114	76	51,2	●	
SPC0066-0528-VA	6,6	8	114	76	52,8	●	
SPC0068-0544-VA	6,8	8	114	76	54,4	●	
SPC0069-0552-VA	6,9	8	114	76	55,2	●	
SPC0070-0560-VA	7,0	8	114	76	56,0	●	
SPC0075-0600-VA	7,5	8	114	76	60,0	●	
SPC0077-0616-VA	7,7	8	114	76	61,6	●	
SPC0078-0624-VA	7,8	8	114	76	62,4	●	
SPC0080-0640-VA	8,0	8	114	76	64,0	●	

Solid carbide drills

Foret hélicoïdal-carbure monobloc

							PG 24
							beschichtet coated revêtu
Schaft Shank Tige	D m7	d <sub>A</sub> h6	l	l <sub>2</sub>	l <sub>4</sub>	TiAIN	
SPC0083-0664-VA	8,3	10	142	95	66,4	●	
SPC0085-0680-VA	8,5	10	142	95	68,0	●	
SPC0090-0720-VA	9,0	10	142	95	72,0	●	
SPC0092-0736-VA	9,2	10	142	95	73,6	●	
SPC0095-0760-VA	9,5	10	142	95	76,0	●	
SPC0096-0768-VA	9,6	10	142	95	76,8	●	
SPC0098-0784-VA	9,8	10	142	95	78,4	●	
SPC0100-0800-VA	10,0	10	142	95	80,0	●	
SPC0102-0816-VA	10,2	12	162	114	81,6	●	
SPC0105-0840-VA	10,5	12	162	114	84,0	●	
SPC0110-0880-VA	11,0	12	162	114	88,0	●	
SPC0112-0896-VA	11,2	12	162	114	89,6	●	
SPC0118-0944-VA	11,8	12	162	114	94,4	●	
SPC0120-0960-VA	12,0	12	162	114	96,0	●	
SPC0125-1000-VA	12,5	14	178	133	100,0	●	
SPC0130-1040-VA	13,0	14	178	133	104,0	●	
SPC0135-1080-VA	13,5	14	178	133	108,0	●	
SPC0140-1120-VA	14,0	14	178	133	112,0	●	

P	○
M	●
K	
N	
S	
H	

● **Hauptanwendung**  
Main application  
Application principale

○ **Nebenanwendung**  
Secondary application  
Application secondaire

Solid carbide drills

Foret hélicoïdal-carbure monobloc

## Ausführung 10 x D / Execution 10 x D / Version 10 x D

Extra lange Ausführung, mit Innenkühlung / Extra long design, with through tool coolant / Version extra longue, avec refroidissement interne

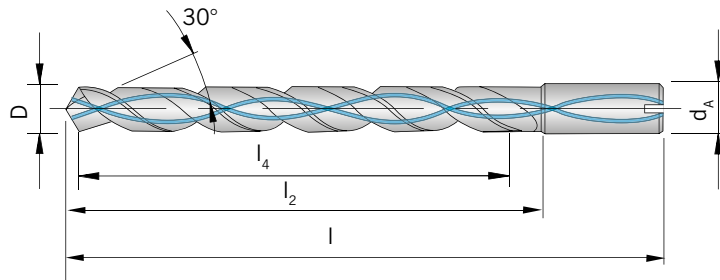

450-488

m7

HAK

140°

h6

3,0 - 14,0 mm

30°

**Feinstkorn**  
Ultra micro  
granulation  
Grain ultra fin

10  
XD

							PG 24
							beschichtet coated revêtu
Schaft Shank Tige	D m7	d <sub>A</sub> h6	l	l <sub>2</sub>	l <sub>4</sub>	TiAIN	
SPC0030-0300-XL	3,0	6	80	40	30	●	
SPC0033-0330-XL	3,3	6	87	47	33	●	
SPC0035-0350-XL	3,5	6	87	47	35	●	
SPC0040-0400-XL	4,0	6	93	53	40	●	
SPC0042-0420-XL	4,2	6	100	60	42	●	
SPC0045-0450-XL	4,5	6	100	60	45	●	
SPC0050-0500-XL	5,0	6	106	66	50	●	
SPC0055-0550-XL	5,5	6	113	73	55	●	
SPC0060-0600-XL	6,0	6	119	79	60	●	
SPC0065-0650-XL	6,5	8	126	86	65	●	
SPC0068-0680-XL	6,8	8	132	92	68	●	
SPC0070-0700-XL	7,0	8	132	92	70	●	
SPC0075-0750-XL	7,5	8	139	99	75	●	
SPC0080-0800-XL	8,0	8	145	105	80	●	
SPC0085-0850-XL	8,5	10	156	112	85	●	
SPC0090-0900-XL	9,0	10	162	118	90	●	
SPC0095-0950-XL	9,5	10	170	126	95	●	
SPC0100-1000-XL	10,0	10	176	132	100	●	
SPC0105-1050-XL	10,5	12	188	139	105	●	
SPC0110-1100-XL	11,0	12	195	145	110	●	
SPC0115-1150-XL	11,5	12	201	152	115	●	
SPC0120-1200-XL	12,0	12	207	158	120	●	
SPC0125-1250-XL	12,5	14	214	165	125	●	
SPC0130-1300-XL	13,0	14	220	171	130	●	
SPC0135-1350-XL	13,5	14	227	178	135	●	
SPC0140-1400-XL	14,0	14	233	184	140	●	

P	●
M	○
K	○
N	
S	
H	

● Hauptanwendung  
Main application  
Application principale

○ Nebenanwendung  
Secondary application  
Application secondaire

Solid carbide drills

Foret hélicoïdal-carbure monobloc

## Ausführung 15 x D / Execution 15 x D / Version 15 x D

Extra lange Ausführung, mit Innenkühlung / Extra long design, with through tool coolant / Version extra longue, avec refroidissement interne

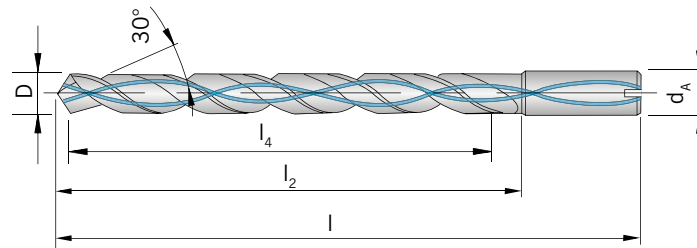

450 - 488

m7

HAK

140°

h6

3,0 - 12,0 mm

30°

**Feinstkorn**  
Ultra micro  
granulation  
Grain ultra fin

15  
XD

							PG 24
							beschichtet coated revêtu
Schaft Shank Tige	D m7	d <sub>A</sub> h6	l	l <sub>2</sub>	l <sub>4</sub>	TITAIN	
SPC0030-0450-XL	3,0	6	95	55	45,0	●	
SPC0032-0480-XL	3,2	6	104	64	48,0	●	
SPC0035-0525-XL	3,5	6	104	64	52,5	●	
SPC0040-0600-XL	4,0	6	113	73	60,0	●	
SPC0045-0675-XL	4,5	6	122	82	67,5	●	
SPC0050-0750-XL	5,0	6	131	91	75,0	●	
SPC0055-0825-XL	5,5	6	140	100	82,5	●	
SPC0060-0900-XL	6,0	6	149	109	90,0	●	
SPC0070-1050-XL	7,0	8	167	127	105,0	●	
SPC0080-1200-XL	8,0	8	185	145	120,0	●	
SPC0085-1275-XL	8,5	10	198	154	127,5	●	
SPC0090-1350-XL	9,0	10	207	163	135,0	●	
SPC0100-1500-XL	10,0	10	226	182	150,0	●	
SPC0105-1575-XL	10,5	12	240	191	157,5	●	
SPC0110-1650-XL	11,0	12	249	200	165,0	●	
SPC0115-1725-XL	11,5	12	258	209	172,5	●	
SPC0120-1800-XL	12,0	12	267	218	180,0	●	

P	●
M	○
K	○
N	
S	
H	

● **Hauptanwendung**  
Main application  
Application principale

○ **Nebenanwendung**  
Secondary application  
Application secondaire

Solid carbide drills

Foret hélicoïdal-carbure monobloc

## Ausführung 20 x D / Execution 20 x D / Version 20 x D

Extra lange Ausführung, mit Innenkühlung / Extra long design, with through tool coolant / Version extra longue, avec refroidissement interne

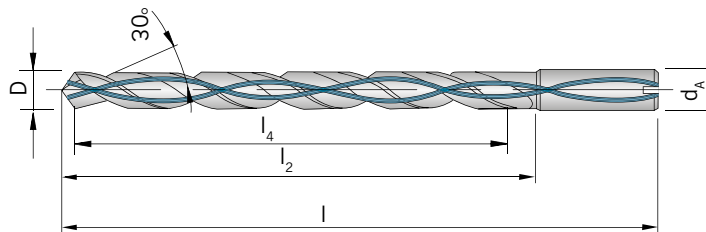

450 - 488

m7

HAK

140°

h6

3,0 - 12,0 mm

30°

**Feinstkorn**  
Ultra micro  
granulation  
Grain ultra fin

20  
XD

							PG 24
							beschichtet coated revêtu
Schaft Shank Tige	D m7	d <sub>A</sub> h6	l	l <sub>2</sub>	l <sub>4</sub>	TiAIN	
SPC0030-0600-XL	3,0	6	110	70	60	●	
SPC0032-0640-XL	3,2	6	122	82	64	●	
SPC0035-0700-XL	3,5	6	122	82	70	●	
SPC0040-0800-XL	4,0	6	133	93	80	●	
SPC0045-0900-XL	4,5	6	145	105	90	●	
SPC0048-0960-XL	4,8	6	156	116	96	●	
SPC0050-1000-XL	5,0	6	156	116	100	●	
SPC0053-1060-XL	5,3	6	168	128	106	●	
SPC0055-1100-XL	5,5	6	168	128	110	●	
SPC0060-1200-XL	6,0	6	179	139	120	●	
SPC0070-1400-XL	7,0	8	202	162	140	●	
SPC0080-1600-XL	8,0	8	225	185	160	●	
SPC0085-1700-XL	8,5	10	241	197	170	●	
SPC0090-1800-XL	9,0	10	252	208	180	●	
SPC0100-2000-XL	10,0	10	276	232	200	●	
SPC0105-2100-XL	10,5	12	293	244	210	●	
SPC0120-2400-XL	12,0	12	327	278	240	●	

P	●
M	○
K	○
N	
S	
H	

● **Hauptanwendung**  
Main application  
Application principale

○ **Nebenanwendung**  
Secondary application  
Application secondaire

Solid carbide drills

Foret hélicoïdal-carbure monobloc

## Ausführung 25 x D / Execution 25 x D / Version 25 x D

Extra lange Ausführung, mit Innenkühlung / Extra long design, with through tool coolant / Version extra longue, avec refroidissement interne

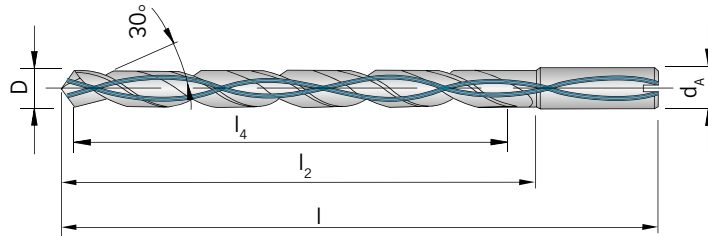

450 - 488

m7

HAK

140°

h6

12,0 - 50,0 mm

30°

**Feinstkorn**  
Ultra micro  
granulation  
Grain ultra fin

25  
XD

							PG 24
							beschichtet coated revêtu
Schaft Shank Tige	D m7	d <sub>A</sub> h6	l	l <sub>2</sub>	l <sub>4</sub>	TiAIN	
SPC0030-0750-XL	3,0	6	125	85	75,0	●	
SPC0035-0875-XL	3,5	6	139	99	87,5	●	
SPC0040-1000-XL	4,0	6	153	113	100,0	●	
SPC0045-1125-XL	4,5	6	167	127	112,5	●	
SPC0050-1250-XL	5,0	6	181	141	125,0	●	
SPC0055-1375-XL	5,5	6	195	155	137,5	●	
SPC0060-1500-XL	6,0	6	209	169	150,0	●	
SPC0070-1750-XL	7,0	8	237	197	175,0	●	
SPC0080-2000-XL	8,0	8	265	225	200,0	●	
SPC0085-2125-XL	8,5	10	283	239	212,5	●	
SPC0090-2250-XL	9,0	10	297	253	225,0	●	
SPC0100-2500-XL	10,0	10	326	282	250,0	●	

P	●
M	○
K	○
N	
S	
H	

● **Hauptanwendung**  
Main application  
Application principale

○ **Nebenanwendung**  
Secondary application  
Application secondaire

Solid carbide drills

Foret hélicoïdal-carbure monobloc

## Ausführung 30 x D / Execution 30 x D / Version 30 x D

Extra lange Ausführung, mit Innenkühlung / Extra long design, with through tool coolant / Version extra longue, avec refroidissement interne

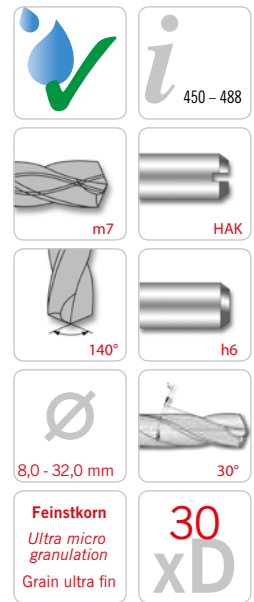
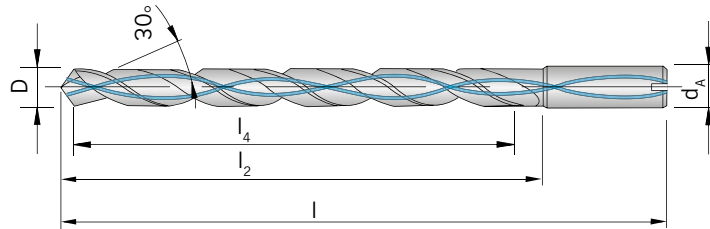

							PG 24
							beschichtet coated revêtu
Schaft Shank Tige	D m7	d <sub>A</sub> h6	l	l <sub>2</sub>	l <sub>4</sub>	TiAIN	
SPC0030-0900-XL	3,0	6	140	100	90	●	
SPC0035-1050-XL	3,5	6	157	117	105	●	
SPC0040-1200-XL	4,0	6	173	133	120	●	
SPC0045-1350-XL	4,5	6	190	150	135	●	
SPC0050-1500-XL	5,0	6	206	166	150	●	
SPC0055-1650-XL	5,5	6	223	183	165	●	
SPC0060-1800-XL	6,0	6	239	199	180	●	
SPC0070-2100-XL	7,0	8	272	232	210	●	
SPC0080-2400-XL	8,0	8	305	265	240	●	

P	●
M	○
K	○
N	
S	
H	

● Hauptanwendung  
Main application  
Application principale

○ Nebenanwendung  
Secondary application  
Application secondaire



Solid carbide NC spot drills  
Foret à pointer NC-carbure monobloc

**NC - Anbohrer 90° / NC spot drill 90° / Foret à pointer NC 90°**  
2 Schneiden, 90° / 2 flutes, 90° / 2 dents, 90°

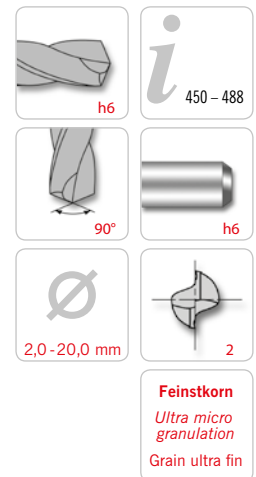

						PG 24
						beschichtet coated revêtu
Schaft Shank Tige	D h6	d <sub>A</sub> h6	l	l <sub>2</sub>	TiAlN	
SPA0020-090	2	2	40	8	●	
SPA0030-090	3	3	40	10	●	
SPA0040-090	4	4	40	12	●	
SPA0050-090	5	5	50	15	●	
SPA0060-090	6	6	50	20	●	
SPA0080-090	8	8	63	22	●	
SPA0100-090	10	10	74	23	●	
SPA0120-090	12	12	83	25	●	
SPA0140-090	14	14	83	26	●	
SPA0160-090	16	16	92	28	●	
SPA0180-090	18	18	92	30	●	
SPA0200-090	20	20	104	30	●	

P	●
M	○
K	○
N	
S	
H	

● **Hauptanwendung**  
Main application  
Application principale

○ **Nebenanwendung**  
Secondary application  
Application secondaire

Solid carbide NC spot drills  
Foret à pointer NC-carbure monobloc

## NC - Anbohrer 120° / NC spot drill 120° / Foret à pointer NC 120° 2 Schneiden, 120° / 2 flutes, 120° / 2 dents, 120°

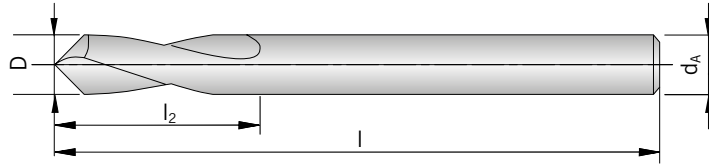

h6

120°

2

2,0 - 20,0 mm

TiAlN

**Feinstkorn**  
Ultra micro granulation  
Grain ultra fin

						PG 24
						beschichtet coated revêtu
Schaft Shank Tige	D h6	d <sub>A</sub> h6	l	l <sub>2</sub>	TiAlN	
SPA0020-120	2	2	40	8	●	
SPA0030-120	3	3	40	10	●	
SPA0040-120	4	4	40	12	●	
SPA0050-120	5	5	50	15	●	
SPA0060-120	6	6	50	20	●	
SPA0080-120	8	8	63	22	●	
SPA0100-120	10	10	74	23	●	
SPA0120-120	12	12	83	25	●	
SPA0140-120	14	14	83	26	●	
SPA0160-120	16	16	92	28	●	
SPA0180-120	18	18	92	30	●	
SPA0200-120	20	20	104	30	●	

P	●
M	○
K	○
N	
S	
H	

● **Hauptanwendung**  
Main application  
Application principale

○ **Nebenanwendung**  
Secondary application  
Application secondaire

Solid carbide NC spot drills  
Foret à pointer NC-carbure monobloc

## NC - Anbohrer 135° / NC spot drill 135° / Foret à pointer NC 135° 2 Schneiden, 135° / 2 flutes, 135° / 2 dents, 135°

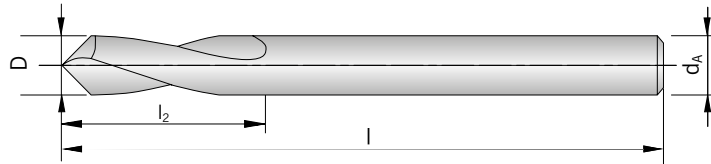

<b>Feinstkorn</b> Ultra micro granulation Grain ultra fin	

						PG 24
						beschichtet coated revêtu
Schaft Shank Tige	D h6	d <sub>A</sub> h6	l	l <sub>2</sub>	TiAIN	
SPA0120-135	12	12	83	25	●	
SPA0160-135	16	16	92	28	●	
SPA0200-135	20	20	104	30	●	

P	●
M	○
K	○
N	
S	
H	

● **Hauptanwendung**  
Main application  
Application principale

○ **Nebenanwendung**  
Secondary application  
Application secondaire

Powder metal NC spot drills  
Foret à pointer-PM-HSS NC

**NC - Anbohrer 90° / NC spot drill 90° / Foret à pointer NC 90°**  
**2 Schneiden, 90° / 2 flutes, 90° / 2 dents, 90°**

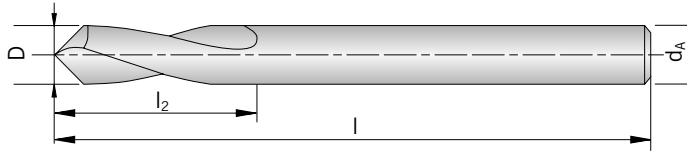

h6

450-488

90°

h6

2,0 - 20,0 mm

2

**PM-HSS**

						PG 24
						beschichtet coated revêtu
Schaft Shank Tige	D h6	d <sub>A</sub> h6	l	l <sub>2</sub>	TiAIN	
SPA0020-090-PM	2	2	40	8	●	
SPA0030-090-PM	3	3	40	10	●	
SPA0040-090-PM	4	4	40	12	●	
SPA0050-090-PM	5	5	50	15	●	
SPA0060-090-PM	6	6	50	20	●	
SPA0080-090-PM	8	8	63	22	●	
SPA0100-090-PM	10	10	74	23	●	
SPA0120-090-PM	12	12	83	25	●	
SPA0140-090-PM	14	14	83	26	●	
SPA0160-090-PM	16	16	92	28	●	
SPA0180-090-PM	18	18	92	30	●	
SPA0200-090-PM	20	20	104	30	●	

P	●
M	○
K	○
N	
S	
H	

● **Hauptanwendung**  
Main application  
Application principale

○ **Nebenanwendung**  
Secondary application  
Application secondaire

Powder metal NC spot drills  
Foret à pointer-PM-HSS NC

**NC - Anbohrer 120° / NC spot drill 120° / Foret à pointer NC 120°**  
**2 Schneiden, 120° / 2 flutes, 120° / 2 dents, 120°**

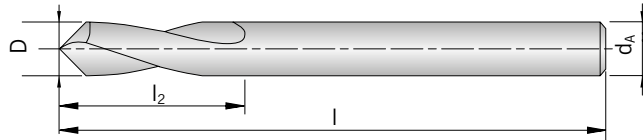

h6

450 - 488

120°

h6

2,0 - 20,0 mm

2

**PM-HSS**

						PG 24
						beschichtet coated revêtu
Schaft Shank Tige	D h6	d <sub>A</sub> h6	l	l <sub>2</sub>	TiAlN	
SPA0020-120-PM	2	2	40	8	●	
SPA0030-120-PM	3	3	40	10	●	
SPA0040-120-PM	4	4	40	12	●	
SPA0050-120-PM	5	5	50	15	●	
SPA0060-120-PM	6	6	50	20	●	
SPA0080-120-PM	8	8	63	22	●	
SPA0100-120-PM	10	10	74	23	●	
SPA0120-120-PM	12	12	83	25	●	
SPA0140-120-PM	14	14	83	26	●	
SPA0160-120-PM	16	16	92	28	●	
SPA0180-120-PM	18	18	92	30	●	
SPA0200-120-PM	20	20	104	30	●	

P	●
M	○
K	○
N	
S	
H	

● **Hauptanwendung**  
Main application  
Application principale

○ **Nebenanwendung**  
Secondary application  
Application secondaire

Powder metal NC spot drills  
Foret à pointer-PM-HSS NC

**NC - Anbohrer 135° / NC spot drill 135° / Foret à pointer NC 135°**  
**2 Schneiden, 135° / 2 flutes, 135° / 2 dents, 135°**

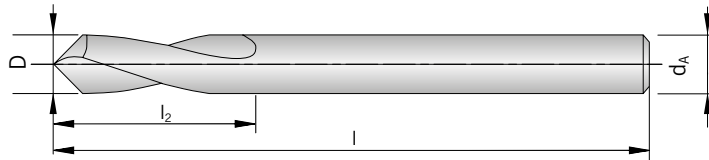
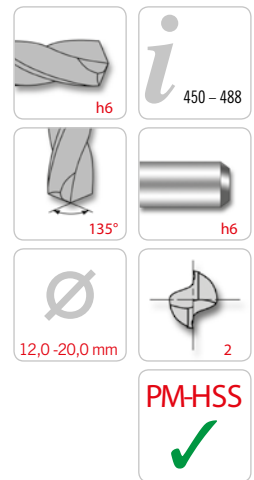

						PG 24
						beschichtet coated revêtu
Schaft Shank Tige	D h6	d <sub>A</sub> h6	l	l <sub>2</sub>	TiAIN	
SPA0120-135-PM	12	12	83	25	●	
SPA0160-135-PM	16	16	92	28	●	
SPA0200-135-PM	20	20	104	30	●	

P	●
M	○
K	○
N	
S	
H	

● **Hauptanwendung**  
Main application  
Application principale

○ **Nebenanwendung**  
Secondary application  
Application secondaire

Solid carbide centre drills  
Foret à centrer en carbure monobloc

## Zentrierbohrer DIN 333, Form A / Centre drills DIN 333, Form A / Foret à centrer DIN 333, Form A



h6



450-488

**Feinstkorn**  
Ultra micro granulation  
Grain ultra fin



1,0-6,3 mm

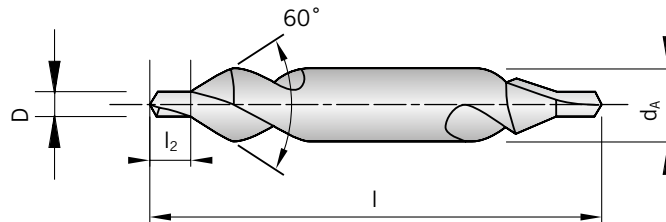

						PG 24
						beschichtet coated revêtu
Schaft Shank Tige	D m7	d <sub>A</sub> h6	l	l <sub>2</sub>	TiAIN	
SPZ0100-0016	1,00	3,15	31,5	1,6	●	
SPZ0125-0019	1,25	3,15	31,5	1,9	●	
SPZ0160-0024	1,60	4,00	35,5	2,4	●	
SPZ0200-0029	2,00	5,00	40,0	2,9	●	
SPZ0250-0036	2,50	6,30	45,0	3,6	●	
SPZ0315-0044	3,15	8,00	50,0	4,4	●	
SPZ0400-0056	4,00	10,00	56,0	5,6	●	
SPZ0500-0069	5,00	12,50	63,0	6,9	●	
SPZ0630-0086	6,30	16,00	71,0	8,6	●	

P	●
M	○
K	○
N	
S	
H	

● **Hauptanwendung**  
Main application  
Application principale

○ **Nebenanwendung**  
Secondary application  
Application secondaire

Powder metal centre drills  
Foret à centrer PM-HSS

Zentrierbohrer DIN 333, Form A / Centre drills DIN 333, Form A /  
Foret à centrer DIN 333, Form A

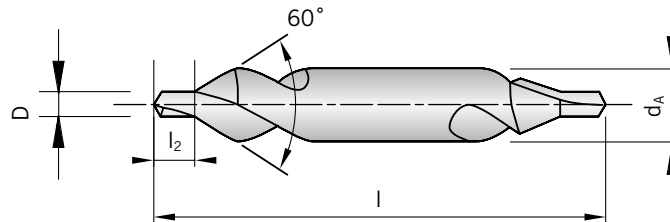

						PG 24
						beschichtet coated revêtu
Schaft Shank Tige	D m7	d <sub>A</sub> h6	l	l <sub>2</sub>	TiAlN	
SPZ0100-0016-PM	1,00	3,15	31,5	1,6	●	
SPZ0125-0019-PM	1,25	3,15	31,5	1,9	●	
SPZ0160-0024-PM	1,60	4,00	35,5	2,4	●	
SPZ0200-0029-PM	2,00	5,00	40,0	2,9	●	
SPZ0250-0036-PM	2,50	6,30	45,0	3,6	●	
SPZ0315-0044-PM	3,15	8,00	50,0	4,4	●	
SPZ0400-0056-PM	4,00	10,00	56,0	5,6	●	
SPZ0500-0069-PM	5,00	12,50	63,0	6,9	●	
SPZ0630-0086-PM	6,30	16,00	71,0	8,6	●	

P	●
M	○
K	○
N	
S	
H	

● Hauptanwendung  
Main application  
Application principale

○ Nebenanwendung  
Secondary application  
Application secondaire



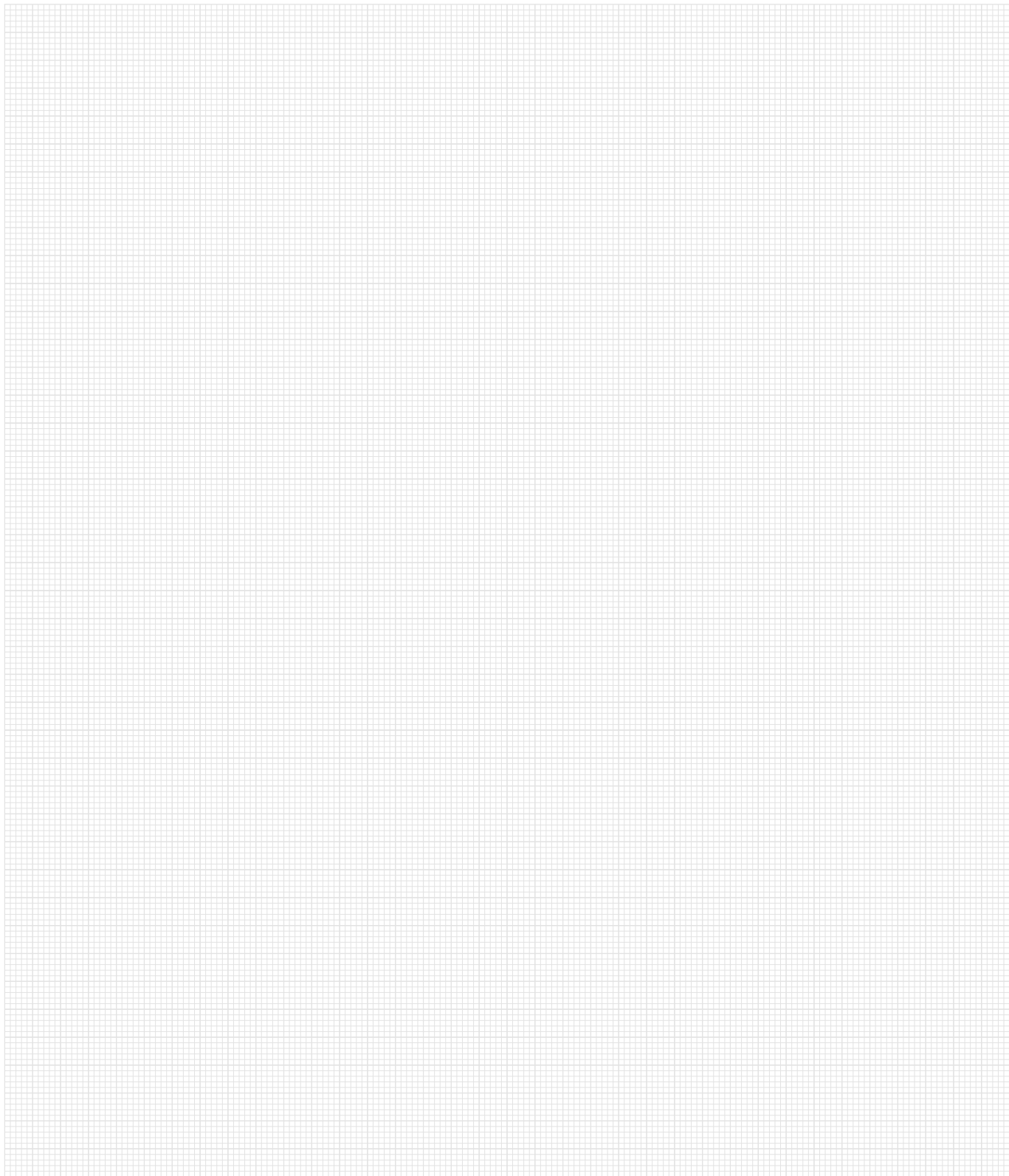

**Weitere Informationen finden Sie unter**  
*For more information see*  
Pour plus d'informations

[www.arno.de](http://www.arno.de)

# Empfohlene Schnittwerte VHM-Schaftfräser ≤ 3xD

Werkstoffgruppe	Gliederung der Werkstoffhauptgruppen und Kennbuchstaben			Brinell-Härte	Zugfestigkeit Rm (N/mm <sup>2</sup> )	Zerspanungsgruppe	Schnittgeschwindigkeit V <sub>c</sub> (m/min)			
							VHM unbeschichtet	VHM TiAlN	VHM Diamant	
P	Unlegierter Stahl	C ≤ 0,25 %	geglüht	125	428	P1	70 - 77 - 84	100 - 110 - 120	-	
		C > 0,25 ... ≤ 0,55 %	geglüht	190	639	P2	70 - 77 - 84	100 - 110 - 120	-	
		C > 0,25 ... ≤ 0,55 %	vergütet	210	708	P3	56 - 63 - 70	80 - 90 - 100	-	
		C > 0,55 %	geglüht	190	639	P4	70 - 77 - 84	100 - 110 - 120	-	
		C > 0,55 %	vergütet	300	1013	P5	56 - 63 - 70	80 - 90 - 100	-	
		Automatenstahl (kurzspanend)	geglüht	220	745	P6	70 - 77 - 84	100 - 110 - 120	-	
	Niedrig legierter Stahl		geglüht	175	591	P7	46 - 54 - 63	65 - 78 - 90	-	
			vergütet	300	1013	P8	35 - 42 - 49	50 - 60 - 70	-	
			vergütet	380	1282	P9	30 - 36 - 42	43 - 52 - 60	-	
			vergütet	430	1477	P10	30 - 36 - 42	43 - 52 - 60	-	
	Hochlegierter Stahl und hochlegierter Werkzeugstahl		geglüht	200	675	P11	46 - 54 - 63	65 - 78 - 90	-	
			gehärtet und angelassen	300	1013	P12	35 - 42 - 49	50 - 60 - 70	-	
			gehärtet und angelassen	400	1361	P13	30 - 36 - 42	43 - 52 - 60	-	
	Nichtrostender Stahl		ferritisch / martensitisch, geglüht	200	675	P14	32 - 37 - 42	45 - 53 - 60	-	
			martensitisch, vergütet	330	1114	P15	25 - 30 - 35	35 - 43 - 50	-	
		austenitisch, abgeschreckt	200	675	M1	32 - 37 - 42	45 - 53 - 60	-		
M	Nichtrostender Stahl		austenitisch, ausscheidungsgehärtet (PH)	300	1013	M2	25 - 30 - 35	35 - 43 - 50	-	
			austenitisch-ferritisch, Duplex	230	778	M3	32 - 37 - 42	45 - 53 - 60	-	
			ferritisch	200	675	K1	63 - 77 - 91	90 - 110 - 130	-	
K	Temperguss		perritisch	260	867	K2	49 - 54 - 60	70 - 78 - 85	-	
			niedrige Festigkeit	180	602	K3	63 - 77 - 91	90 - 110 - 130	-	
	Grauguss		hohe Festigkeit / austenitisch	245	825	K4	49 - 54 - 60	70 - 78 - 85	-	
			ferritisch	155	518	K5	63 - 77 - 91	90 - 110 - 130	-	
	Gusseisen mit Kugelgraphit		perritisch	265	885	K6	49 - 54 - 60	70 - 78 - 85	-	
		GGV (CGI)			200	675	K7	63 - 77 - 91	90 - 110 - 130	-
N	Aluminium-Knetlegierungen		nicht aushärtbar	30	-	N1	50 - 60 - 70	-	140 - 260 - 380	
			aushärtbar, ausgehärtet	100	343	N2	50 - 60 - 70	-	141 - 260 - 380	
			≤ 12 % Si, nicht aushärtbar	75	260	N3	50 - 60 - 70	-	120 - 210 - 300	
	Aluminium-Gusslegierungen		≤ 12 % Si, aushärtbar, ausgehärtet	90	314	N4	50 - 60 - 70	-	120 - 210 - 300	
			> 12 % Si, nicht aushärtbar	130	447	N5	50 - 60 - 70	-	120 - 180 - 240	
	Magnesiumlegierungen			70	250	N6	-	-	140 - 260 - 380	
	Kupfer und Kupferlegierungen (Bronze / Messing)		unlegiert, Elektrolytkupfer	100	343	N7	49 - 95 - 140	70 - 135 - 200	-	
			Messing, Bronze, Rotguss	90	314	N8	49 - 95 - 140	70 - 135 - 200	120 - 180 - 240	
			Cu-Legierung, kurzspanend	110	382	N9	49 - 95 - 140	70 - 135 - 200	140 - 260 - 380	
			hochfest, Ampco	300	1013	N10	49 - 94 - 140	70 - 135 - 200	120 - 180 - 240	
Nichtmetallische Werkstoffe		Thermoplaste (ohne abrasive Füllstoffe)	-	-	N11	20 - 30 - 40	-	-		
		Duroplaste (ohne abrasive Füllstoffe)	-	-	N12	20 - 30 - 40	-	-		
		Kunststoff glasfaserverstärkt GFRP	-	-	N13	-	-	-		
		Kunststoff kohlefaserverstärkt CFRP	-	-	N14	-	-	-		
		Kunststoff aramidfaserverstärkt AFRP	-	-	N15	-	-	-		
		Graphit (technisch)		80 Shore	-	N16	-	-	-	
S	Warmfeste Legierungen		Fe-Basis	geglüht	200	675	S1	11 - 17 - 23	15 - 24 - 33	-
				ausgehärtet	280	943	S2	11 - 17 - 23	15 - 24 - 33	-
				geglüht	250	839	S3	11 - 17 - 23	15 - 24 - 33	-
			Ni- oder Co-Basis	ausgehärtet	350	1177	S4	11 - 17 - 23	15 - 24 - 33	-
				gegossen	320	1076	S5	11 - 17 - 23	15 - 24 - 33	-
	Titanlegierungen		Reintitan	200	675	S6	11 - 19 - 27	15 - 24 - 33	-	
			α- und β-Legierungen, ausgehärtet	375	1262	S7	11 - 19 - 27	15 - 24 - 33	-	
			β-Legierungen	410	1396	S8	11 - 19 - 27	15 - 24 - 33	-	
	Wolframlegierungen			300	1013	S9	-	-	-	
	Molybdänlegierungen			300	1013	S10	-	-	-	
H	Gehärteter Stahl		gehärtet und angelassen	50 HRC	-	H1	-	-	-	
			gehärtet und angelassen	55 HRC	-	H2	-	-	-	
			gehärtet und angelassen	60 HRC	-	H3	-	-	-	
	Gehärtetes Gusseisen		gehärtet und angelassen	55 HRC	-	H4	-	-	-	

Die Tabellenwerte sind Richtwerte. Es kann notwendig sein, die Werte den jeweiligen Bearbeitungsumständen anzupassen.



Material group	Structure of the material groups and identification letters		Brinell hardness HB	Tensile strength Rm (N/mm <sup>2</sup> )	Chipping group	Cutting speed V <sub>c</sub> (m/min)		
						VHM uncoated	VHM TiAlN	VHM diamond
P	Unalloyed steel	C ≤ 0.25 % annealed	125	428	P1	70 - 77 - 84	100 - 110 - 120	-
		C > 0.25 ... ≤ 0.55 % annealed	190	639	P2	70 - 77 - 84	100 - 110 - 120	-
		C > 0.25 ... ≤ 0.55 % hardened and tempered	210	708	P3	56 - 63 - 70	80 - 90 - 100	-
		C > 0.55 % annealed	190	639	P4	70 - 77 - 84	100 - 110 - 120	-
		C > 0.55 % hardened and tempered	300	1013	P5	56 - 63 - 70	80 - 90 - 100	-
		Machining steel (short-chipping) tempered	220	745	P6	70 - 77 - 84	100 - 110 - 120	-
	Low alloyed steel	annealed	175	591	P7	46 - 54 - 63	65 - 78 - 90	-
		hardened and tempered	300	1013	P8	35 - 42 - 49	50 - 60 - 70	-
		hardened and tempered	380	1282	P9	30 - 36 - 42	43 - 52 - 60	-
		hardened and tempered	430	1477	P10	30 - 36 - 42	43 - 52 - 60	-
	High alloyed steel and high alloyed tool steel	annealed	200	675	P11	46 - 54 - 63	65 - 78 - 90	-
		hardened	300	1013	P12	35 - 42 - 49	50 - 60 - 70	-
		hardened	400	1361	P13	30 - 36 - 42	43 - 52 - 60	-
	Stainless steel	ferritic / martensitic, annealed	200	675	P14	32 - 37 - 42	45 - 53 - 60	-
		martensitic, hardened and tempered	330	1114	P15	25 - 30 - 35	35 - 43 - 50	-
M	Stainless steel	austenitic, chilled	200	675	M1	32 - 37 - 42	45 - 53 - 60	-
		austenitic, precipitation-hardened (PH)	300	1013	M2	25 - 30 - 35	35 - 43 - 50	-
		austenitic-ferritic, Duplex	230	778	M3	32 - 37 - 42	45 - 53 - 60	-
K	Malleable cast iron	ferritic	200	675	K1	63 - 77 - 91	90 - 110 - 130	-
		pearlitic	260	867	K2	49 - 54 - 60	70 - 78 - 85	-
	Cast iron	low tensile strength	180	602	K3	63 - 77 - 91	90 - 110 - 130	-
		high tensile strength / austenitic	245	825	K4	49 - 54 - 60	70 - 78 - 85	-
	Cast iron with nodular graphite	ferritic	155	518	K5	63 - 77 - 91	90 - 110 - 130	-
		pearlitic	265	885	K6	49 - 54 - 60	70 - 78 - 85	-
GGV (CGI)		200	675	K7	63 - 77 - 91	90 - 110 - 130	-	
N	Aluminium alloys long chipping	not heat treatable	30	-	N1	50 - 60 - 70	-	140 - 260 - 380
		heat treatable, heat treated	100	343	N2	50 - 60 - 70	-	141 - 260 - 380
	Casted aluminium alloys	≤ 12 % Si, not heat treatable	75	260	N3	50 - 60 - 70	-	120 - 210 - 300
		≤ 12 % Si, aushärtbar, ausgehärtet	90	314	N4	50 - 60 - 70	-	120 - 210 - 300
		> 12 % Si, not heat treatable	130	447	N5	50 - 60 - 70	-	120 - 180 - 240
	Magnesium alloys		70	250	N6	-	-	140 - 260 - 380
	Copper and copper alloys (Brass / Bronze)	Unalloyed, elektrolyte copper	100	343	N7	49 - 95 - 140	70 - 135 - 200	-
		Brass, Bronze	90	314	N8	49 - 95 - 140	70 - 135 - 200	120 - 180 - 240
		Cu-alloys, short-chipping	110	382	N9	49 - 95 - 140	70 - 135 - 200	140 - 260 - 380
		High-tensile, Ampco	300	1013	N10	49 - 94 - 140	70 - 135 - 200	120 - 180 - 240
	Non-ferrous materials	Lead alloys (without abrasive filling material)	-	-	N11	20 - 30 - 40	-	-
Duroplastic (without abrasive filling material)		-	-	N12	20 - 30 - 40	-	-	
Plastic glas fibre reinforced GFRP		-	-	N13	-	-	-	
Plastic carbon fibre reinforced CFRP		-	-	N14	-	-	-	
Plastic aramid fibre reinforced AFRP		-	-	N15	-	-	-	
Graphite (tech.)		80 Shore	-	N16	-	-	-	
S	High temperature resistant alloys	Fe-Basis annealed	200	675	S1	11 - 17 - 23	15 - 24 - 33	-
		Fe-Basis heat treated	280	943	S2	11 - 17 - 23	15 - 24 - 33	-
		Ni- or Co-alloyed annealed	250	839	S3	11 - 17 - 23	15 - 24 - 33	-
		Ni- or Co-alloyed heat treated	350	1177	S4	11 - 17 - 23	15 - 24 - 33	-
		Ni- or Co-alloyed casting	320	1076	S5	11 - 17 - 23	15 - 24 - 33	-
	Titanium alloys	Pure titan	200	675	S6	11 - 19 - 27	15 - 24 - 33	-
		α- and β-alloys, heat treated	375	1262	S7	11 - 19 - 27	15 - 24 - 33	-
		β-alloys	410	1396	S8	11 - 19 - 27	15 - 24 - 33	-
	Wolfram alloys		300	1013	S9	-	-	-
	Molybdän alloys		300	1013	S10	-	-	-
H	Hardened steel	hardened	50 HRC	-	H1	-	-	-
		hardened	55 HRC	-	H2	-	-	-
		hardened	60 HRC	-	H3	-	-	-
	Hardened cast iron	hardened	55 HRC	-	H4	-	-	-

The recommended cutting data are only approximate values. It may be necessary to adjust them to each individual machining application.



# Tableaux des avances valeurs de coupe recommandées ≤ 3xD

ISO	Matériaux		Dureté Brinell	Résistance (N/mm <sup>2</sup> )	Groupe d'usinage	Vitesse de coupe Vc (m/min)		
						VHM sans revêtement	VHM TAIN	VHM diamant
P	Acier non allié	C ≤ 0,25 % recuit	125	428	P1	70 - 77 - 84	100 - 110 - 120	-
		C > 0,25 ... ≤ 0,55 % recuit	190	639	P2	70 - 77 - 84	100 - 110 - 120	-
		C > 0,25 ... ≤ 0,55 % traité	210	708	P3	56 - 63 - 70	80 - 90 - 100	-
		C > 0,55 % recuit	190	639	P4	70 - 77 - 84	100 - 110 - 120	-
		C > 0,55 % traité	300	1013	P5	56 - 63 - 70	80 - 90 - 100	-
		Aciers de décolletage (à copeaux courts) recuit	220	745	P6	70 - 77 - 84	100 - 110 - 120	-
	Acier faiblement allié	recuit	175	591	P7	46 - 54 - 63	65 - 78 - 90	-
		traité	300	1013	P8	35 - 42 - 49	50 - 60 - 70	-
		traité	380	1282	P9	30 - 36 - 42	43 - 52 - 60	-
		traité	430	1477	P10	30 - 36 - 42	43 - 52 - 60	-
	Acier allié et acier outil allié	recuit	200	675	P11	46 - 54 - 63	65 - 78 - 90	-
		trempe et revenu	300	1013	P12	35 - 42 - 49	50 - 60 - 70	-
		trempe et revenu	400	1361	P13	30 - 36 - 42	43 - 52 - 60	-
	Acier inox	ferritique, martensitique, recuit	200	675	P14	32 - 37 - 42	45 - 53 - 60	-
		martensitique, traité	330	1114	P15	25 - 30 - 35	35 - 43 - 50	-
M	Acier inox	austénitique	200	675	M1	32 - 37 - 42	45 - 53 - 60	-
		austénitique	300	1013	M2	25 - 30 - 35	35 - 43 - 50	-
		austénitique-ferritique, Duplex	230	778	M3	32 - 37 - 42	45 - 53 - 60	-
K	Fonte malléable	ferritique	200	675	K1	63 - 77 - 91	90 - 110 - 130	-
		perlitique	260	867	K2	49 - 54 - 60	70 - 78 - 85	-
	Fonte grise	faible résistance	180	602	K3	63 - 77 - 91	90 - 110 - 130	-
		haute résistance / austénitique	245	825	K4	49 - 54 - 60	70 - 78 - 85	-
	Fonte à Graphite sphéroïdale	ferritique	155	518	K5	63 - 77 - 91	90 - 110 - 130	-
		perlitique	265	885	K6	49 - 54 - 60	70 - 78 - 85	-
GGV (CGI)		200	675	K7	63 - 77 - 91	90 - 110 - 130	-	
N	Alliages de fonderie d'aluminium	ne pouvant pas subir un durcissement	30	-	N1	50 - 60 - 70	-	140 - 260 - 380
		pouvant subir un durcissement, durci	100	343	N2	50 - 60 - 70	-	141 - 260 - 380
	Alliage de fonte d'aluminium	≤ 12 % Si, ne pouvant pas subir de durcissement	75	260	N3	50 - 60 - 70	-	120 - 210 - 300
		≤ 12 % Si, pouvant subir un durcissement, durci	90	314	N4	50 - 60 - 70	-	120 - 210 - 300
		> 12 % Si, ne pouvant pas subir de durcissement	130	447	N5	50 - 60 - 70	-	120 - 180 - 240
	Alliage de Magnésium		70	250	N6	-	-	140 - 260 - 380
	Cuivre et alliage de cuivre (bronze / laiton)	non allié, cuivre électrolytique	100	343	N7	49 - 95 - 140	70 - 135 - 200	-
		Laiton, bronze, fonte rouge	90	314	N8	49 - 95 - 140	70 - 135 - 200	120 - 180 - 240
		Alliage de cuivre à copeaux courts	110	382	N9	49 - 95 - 140	70 - 135 - 200	140 - 260 - 380
		forte résistance, Ampco	300	1013	N10	49 - 94 - 140	70 - 135 - 200	120 - 180 - 240
Matériaux non métalliques	Thermoplaste (sans agents de charge abrasives)	-	-	N11	20 - 30 - 40	-	-	
	Duroplaste (sans agents de charge abrasives)	-	-	N12	20 - 30 - 40	-	-	
	Matière plastique renforcée de fibres de verre GFRP	-	-	N13	-	-	-	
	Matière plastique renforcé composite CFRP	-	-	N14	-	-	-	
	Plastique renforcé fibre aramide AFRP	-	-	N15	-	-	-	
	Graphite	80 Shore	-	N16	-	-	-	
S	Alliages réfractaires	à base de Fe recuit	200	675	S1	11 - 17 - 23	15 - 24 - 33	-
		à base de Fe durci	280	943	S2	11 - 17 - 23	15 - 24 - 33	-
		à base de Fe recuit	250	839	S3	11 - 17 - 23	15 - 24 - 33	-
		à base Ni ou Co durci	350	1177	S4	11 - 17 - 23	15 - 24 - 33	-
		à base Ni ou Co jeter	320	1076	S5	11 - 17 - 23	15 - 24 - 33	-
	Alliage de titane	Titane pur	200	675	S6	11 - 19 - 27	15 - 24 - 33	-
		Alliages Alpha + Beta, trempé	375	1262	S7	11 - 19 - 27	15 - 24 - 33	-
		Alliages Beta	410	1396	S8	11 - 19 - 27	15 - 24 - 33	-
	Alliage de tungstène		300	1013	S9	-	-	-
	Alliage de molybdène		300	1013	S10	-	-	-
H	Acier trempé	trempe et revenu	50 HRC	-	H1	-	-	-
		trempe et revenu	55 HRC	-	H2	-	-	-
		trempe et revenu	60 HRC	-	H3	-	-	-
	Fonte durci	trempe et revenu	55 HRC	-	H4	-	-	-

Les valeurs du tableau sont indicatives. Il peut être nécessaire de les adapter aux conditions d'usinage respectives.



# Empfohlene Schnittwerte VHM-Schaftfräser ≤ 5xD

Werkstoffgruppe	Gliederung der Werkstoffhauptgruppen und Kennbuchstaben		Brinell-Härte	Zugfestigkeit Rm (N/mm <sup>2</sup> )	Zerspanungsgruppe	Schnittgeschwindigkeit V <sub>c</sub> (m/min)			
						VHM TiAlN	VHM Diamant		
P	Unlegierter Stahl	C ≤ 0,25 %	geglüht	125	428	P1	100 - 110 - 120	-	
		C > 0,25 ... ≤ 0,55 %	geglüht	190	639	P2	100 - 110 - 120	-	
		C > 0,25 ... ≤ 0,55 %	vergütet	210	708	P3	80 - 90 - 100	-	
		C > 0,55 %	geglüht	190	639	P4	100 - 110 - 120	-	
		C > 0,55 %	vergütet	300	1013	P5	80 - 90 - 100	-	
		Automatenstahl (kurzspanend)	geglüht	220	745	P6	100 - 110 - 120	-	
	Niedrig legierter Stahl		geglüht	175	591	P7	65 - 78 - 90	-	
			vergütet	300	1013	P8	50 - 60 - 70	-	
			vergütet	380	1282	P9	43 - 52 - 60	-	
			vergütet	430	1477	P10	43 - 52 - 60	-	
	Hochlegierter Stahl und hochlegierter Werkzeugstahl		geglüht	200	675	P11	65 - 78 - 90	-	
			gehärtet und angelassen	300	1013	P12	50 - 60 - 70	-	
			gehärtet und angelassen	400	1361	P13	43 - 52 - 60	-	
	Nichtrostender Stahl		ferritisch / martensitisch, geglüht	200	675	P14	45 - 53 - 60	-	
			martensitisch, vergütet	330	1114	P15	35 - 43 - 50	-	
M	Nichtrostender Stahl		austenitisch, abgeschreckt	200	675	M1	45 - 53 - 60	-	
			austenitisch, ausscheidungsgehärtet (PH)	300	1013	M2	35 - 43 - 50	-	
			austenitisch-ferritisch, Duplex	230	778	M3	45 - 53 - 60	-	
K	Temperguss		ferritisch	200	675	K1	90 - 110 - 130	-	
			perritisch	260	867	K2	70 - 78 - 85	-	
	Grauguss		niedrige Festigkeit	180	602	K3	90 - 110 - 130	-	
			hohe Festigkeit / austenitisch	245	825	K4	70 - 78 - 85	-	
	Gusseisen mit Kugelgraphit		ferritisch	155	518	K5	90 - 110 - 130	-	
			perritisch	265	885	K6	70 - 78 - 85	-	
	GGV (CGI)		200	675	K7	90 - 110 - 130	-		
N	Aluminium-Knetlegierungen		nicht aushärtbar	30	-	N1	-	140 - 260 - 380	
			aushärtbar, ausgehärtet	100	343	N2	-	140 - 260 - 380	
	Aluminium-Gusslegierungen		≤ 12 % Si, nicht aushärtbar	75	260	N3	-	120 - 210 - 300	
			≤ 12 % Si, aushärtbar, ausgehärtet	90	314	N4	-	120 - 210 - 300	
			> 12 % Si, nicht aushärtbar	130	447	N5	-	120 - 180 - 240	
		Magnesiumlegierungen		70	250	N6	-	140 - 260 - 380	
	Kupfer und Kupferlegierungen (Bronze / Messing)		unlegiert, Elektrolytkupfer	100	343	N7	70 - 135 - 200	-	
			Messing, Bronze, Rotguss	90	314	N8	70 - 135 - 200	120 - 180 - 240	
			Cu-Legierung, kurzspanend	110	382	N9	70 - 135 - 200	140 - 260 - 380	
			hochfest, Ampco	300	1013	N10	70 - 135 - 200	120 - 180 - 240	
Nichtmetallische Werkstoffe		Thermoplaste (ohne abrasive Füllstoffe)	-	-	N11	-	-		
		Duroplaste (ohne abrasive Füllstoffe)	-	-	N12	-	-		
		Kunststoff glasfaserverstärkt GFRP	-	-	N13	-	-		
		Kunststoff kohlefaserverstärkt CFRP	-	-	N14	-	-		
		Kunststoff aramidfaserverstärkt AFRP	-	-	N15	-	-		
		Graphit (technisch)		80 Shore	-	N16	-	-	
S	Warmfeste Legierungen		Fe-Basis	geglüht	200	675	S1	15 - 24 - 33	-
				ausgehärtet	280	943	S2	15 - 24 - 33	-
				geglüht	250	839	S3	15 - 24 - 33	-
			Ni- oder Co-Basis	ausgehärtet	350	1177	S4	15 - 24 - 33	-
				gegossen	320	1076	S5	15 - 24 - 33	-
	Titanlegierungen		Reintitan		200	675	S6	15 - 27 - 39	-
			α- und β-Legierungen, ausgehärtet		375	1262	S7	15 - 27 - 39	-
			β-Legierungen		410	1396	S8	15 - 27 - 39	-
		Wolframlegierungen		300	1013	S9	-	-	
		Molybdänlegierungen		300	1013	S10	-	-	
H	Gehärteter Stahl		gehärtet und angelassen	50 HRC	-	H1	14 - 18 - 22	-	
			gehärtet und angelassen	55 HRC	-	H2	10 - 13 - 16	-	
			gehärtet und angelassen	60 HRC	-	H3	8 - 11 - 13	-	
		Gehärtetes Gusseisen	gehärtet und angelassen	55 HRC	-	H4	10 - 13 - 16	-	

Die Tabellenwerte sind Richtwerte. Es kann notwendig sein, die Werte den jeweiligen Bearbeitungsumständen anzupassen.





Material group	Structure of the material groups and identification letters		Brinell hardness HB	Tensile strength Rm (N/mm <sup>2</sup> )	Chipping group	Cutting speed V <sub>c</sub> (m/min)		
						VHM TAIN	VHM diamond	
P	Unalloyed steel	C ≤ 0.25 % annealed	125	428	P1	100 - 110 - 120	-	
		C > 0.25 ... ≤ 0.55 % annealed	190	639	P2	100 - 110 - 120	-	
		C > 0.25 ... ≤ 0.55 % hardened and tempered	210	708	P3	80 - 90 - 100	-	
		C > 0.55 % annealed	190	639	P4	100 - 110 - 120	-	
		C > 0.55 % hardened and tempered	300	1013	P5	80 - 90 - 100	-	
		Machining steel (short-chipping) tempered	220	745	P6	100 - 110 - 120	-	
	Low alloyed steel	annealed	175	591	P7	65 - 78 - 90	-	
		hardened and tempered	300	1013	P8	50 - 60 - 70	-	
		hardened and tempered	380	1282	P9	43 - 52 - 60	-	
		hardened and tempered	430	1477	P10	43 - 52 - 60	-	
	High alloyed steel and high alloyed tool steel	annealed	200	675	P11	65 - 78 - 90	-	
		hardened	300	1013	P12	50 - 60 - 70	-	
		hardened	400	1361	P13	43 - 52 - 60	-	
	Stainless steel	ferritic / martensitic, annealed	200	675	P14	45 - 53 - 60	-	
		martensitic, hardened and tempered	330	1114	P15	35 - 43 - 50	-	
M	Stainless steel	austenitic, chilled	200	675	M1	45 - 53 - 60	-	
		austenitic, precipitation-hardened (PH)	300	1013	M2	35 - 43 - 50	-	
		austenitic-ferritic, Duplex	230	778	M3	45 - 53 - 60	-	
K	Malleable cast iron	ferritic	200	675	K1	90 - 110 - 130	-	
		pearlitic	260	867	K2	70 - 78 - 85	-	
	Cast iron	low tensile strength	180	602	K3	90 - 110 - 130	-	
		high tensile strength / austenitic	245	825	K4	70 - 78 - 85	-	
	Cast iron with nodular graphite	ferritic	155	518	K5	90 - 110 - 130	-	
		pearlitic	265	885	K6	70 - 78 - 85	-	
GGV (CGI)		200	675	K7	90 - 110 - 130	-		
N	Aluminium alloys long chipping	not heat treatable	30	-	N1	-	140 - 260 - 380	
		heat treatable, heat treated	100	343	N2	-	140 - 260 - 380	
	Casted aluminium alloys	≤ 12 % Si, not heat treatable	75	260	N3	-	120 - 210 - 300	
		≤ 12 % Si, aushärtbar, ausgehärtet	90	314	N4	-	120 - 210 - 300	
		> 12 % Si, not heat treatable	130	447	N5	-	120 - 180 - 240	
	Magnesium alloys		70	250	N6	-	140 - 260 - 380	
	Copper and copper alloys (Brass / Bronze)	Unalloyed, elektrolyte copper	100	343	N7	70 - 135 - 200	-	
		Brass, Bronze	90	314	N8	70 - 135 - 200	120 - 180 - 240	
		Cu-alloys, short-chipping	110	382	N9	70 - 135 - 200	140 - 260 - 380	
		High-tensile, Ampco	300	1013	N10	70 - 135 - 200	120 - 180 - 240	
Non-ferrous materials	Lead alloys (without abrasive filling material)	-	-	N11	-	-		
	Duroplastic (without abrasive filling material)	-	-	N12	-	-		
	Plastic glas fibre reinforced GFRP	-	-	N13	-	-		
	Plastic carbon fibre reinforced CFRP	-	-	N14	-	-		
	Plastic aramid fibre reinforced AFRP	-	-	N15	-	-		
	Graphite (tech.)	80 Shore	-	N16	-	-		
S	High temperature resistant alloys	Fe-Basis	annealed	200	675	S1	15 - 24 - 33	-
			heat treated	280	943	S2	15 - 24 - 33	-
		Ni- or Co-alloyed	annealed	250	839	S3	15 - 24 - 33	-
			heat treated	350	1177	S4	15 - 24 - 33	-
			casting	320	1076	S5	15 - 24 - 33	-
	Titanium alloys	Pure titan	200	675	S6	15 - 27 - 39	-	
		α- and β-alloys, heat treated	375	1262	S7	15 - 27 - 39	-	
		β-alloys	410	1396	S8	15 - 27 - 39	-	
	Wolfram alloys		300	1013	S9	-	-	
	Molybdän alloys		300	1013	S10	-	-	
H	Hardened steel	hardened	50 HRC	-	H1	14 - 18 - 22	-	
		hardened	55 HRC	-	H2	10 - 13 - 16	-	
		hardened	60 HRC	-	H3	8 - 11 - 13	-	
	Hardened cast iron	hardened	55 HRC	-	H4	10 - 13 - 16	-	

The recommended cutting data are only approximate values. It may be necessary to adjust them to each individual machining application.

SP



# Tableaux des avances valeurs de coupe recommandées ≤ 5xD

ISO	Matériaux		Dureté Brinell	Résistance (N/mm <sup>2</sup> )	Groupe d'usinage	Vitesse de coupe Vc (m/min)		
						VHM TAIN	VHM diamant	
P	Acier non allié	C ≤ 0,25 % recuit	125	428	P1	100 - 110 - 120	-	
		C > 0,25 ... ≤ 0,55 % recuit	190	639	P2	100 - 110 - 120	-	
		C > 0,25 ... ≤ 0,55 % traité	210	708	P3	80 - 90 - 100	-	
		C > 0,55 % recuit	190	639	P4	100 - 110 - 120	-	
		C > 0,55 % traité	300	1013	P5	80 - 90 - 100	-	
		Aciers de décolletage (à copeaux courts) recuit	220	745	P6	100 - 110 - 120	-	
	Acier faiblement allié	recuit	175	591	P7	65 - 78 - 90	-	
		traité	300	1013	P8	50 - 60 - 70	-	
		traité	380	1282	P9	43 - 52 - 60	-	
		traité	430	1477	P10	43 - 52 - 60	-	
	Acier allié et acier outil allié	recuit	200	675	P11	65 - 78 - 90	-	
		trempe et revenu	300	1013	P12	50 - 60 - 70	-	
		trempe et revenu	400	1361	P13	43 - 52 - 60	-	
	Acier inox	ferritique, martensitique, recuit	200	675	P14	45 - 53 - 60	-	
		martensitique, traité	330	1114	P15	35 - 43 - 50	-	
M	Acier inox	austénitique	200	675	M1	45 - 53 - 60	-	
		austénitique	300	1013	M2	35 - 43 - 50	-	
		austénitique-ferritique, Duplex	230	778	M3	45 - 53 - 60	-	
K	Fonte malléable	ferritique	200	675	K1	90 - 110 - 130	-	
		perlitique	260	867	K2	70 - 78 - 85	-	
	Fonte grise	faible résistance	180	602	K3	90 - 110 - 130	-	
		haute résistance / austénitique	245	825	K4	70 - 78 - 85	-	
	Fonte à Graphite sphéroïdale	ferritique	155	518	K5	90 - 110 - 130	-	
		perlitique	265	885	K6	70 - 78 - 85	-	
GGV (CGI)		200	675	K7	90 - 110 - 130	-		
N	Alliages de fonderie d'aluminium	ne pouvant pas subir un durcissement	30	-	N1	-	140 - 260 - 380	
		pouvant subir un durcissement, durci	100	343	N2	-	140 - 260 - 380	
	Alliage de fonte d'aluminium	≤ 12 % Si, ne pouvant pas subir de durcissement	75	260	N3	-	120 - 210 - 300	
		≤ 12 % Si, pouvant subir un durcissement, durci	90	314	N4	-	120 - 210 - 300	
		> 12 % Si, ne pouvant pas subir de durcissement	130	447	N5	-	120 - 180 - 240	
	Alliage de Magnésium		70	250	N6	-	140 - 260 - 380	
	Cuivre et alliage de cuivre (bronze / laiton)	non allié, cuivre électrolytique	100	343	N7	70 - 135 - 200	-	
		Laiton, bronze, fonte rouge	90	314	N8	70 - 135 - 200	120 - 180 - 240	
		Alliage de cuivre à copeaux courts	110	382	N9	70 - 135 - 200	140 - 260 - 380	
		forte résistance, Ampco	300	1013	N10	70 - 135 - 200	120 - 180 - 240	
Matériaux non métalliques	Thermoplaste (sans agents de charge abrasives)	-	-	N11	-	-		
	Duroplaste (sans agents de charge abrasives)	-	-	N12	-	-		
	Matière plastique renforcée de fibres de verre GFRP	-	-	N13	-	-		
	Matière plastique renforcé composite CFRP	-	-	N14	-	-		
	Plastique renforcé fibre aramide AFRP	-	-	N15	-	-		
	Graphite	80 Shore	-	N16	-	-		
S	Alliages réfractaires	à base de Fe recuit	200	675	S1	15 - 24 - 33	-	
		à base de Fe durci	280	943	S2	15 - 24 - 33	-	
		à base de Fe recuit	250	839	S3	15 - 24 - 33	-	
		à base Ni ou Co durci	350	1177	S4	15 - 24 - 33	-	
		à base Ni ou Co jeter	320	1076	S5	15 - 24 - 33	-	
	Alliage de titane	Titane pur	200	675	S6	15 - 27 - 39	-	
		Alliages Alpha + Beta, trempé	375	1262	S7	15 - 27 - 39	-	
		Alliages Beta	410	1396	S8	15 - 27 - 39	-	
	Alliage de tungstène		300	1013	S9	-	-	
	Alliage de molybdène		300	1013	S10	-	-	
H	Acier trempé	trempe et revenu	50 HRC	-	H1	14 - 18 - 22	-	
		trempe et revenu	55 HRC	-	H2	10 - 13 - 16	-	
		trempe et revenu	60 HRC	-	H3	8 - 11 - 13	-	
	Fonte durci	trempe et revenu	55 HRC	-	H4	10 - 13 - 16	-	

Les valeurs du tableau sont indicatives. Il peut être nécessaire de les adapter aux conditions d'usinage respectives.



# Empfohlene Schnittwerte VHM-Schaftfräser ≤ 10xD

Werkstoffgruppe	Gliederung der Werkstoffhauptgruppen und Kennbuchstaben			Brinell-Härte	Zugfestigkeit Rm (N/mm <sup>2</sup> )	Zerspanungsgruppe	Schnittgeschwindigkeit V <sub>c</sub> (m/min)			
							VHM unbeschichtet	VHM TiAlN	VHM Diamant	
P	Unlegierter Stahl	C ≤ 0,25 %	geglüht	125	428	P1	70 - 77 - 84	100 - 110 - 120	-	
		C > 0,25 ... ≤ 0,55 %	geglüht	190	639	P2	70 - 77 - 84	100 - 110 - 120	-	
		C > 0,25 ... ≤ 0,55 %	vergütet	210	708	P3	56 - 63 - 70	80 - 90 - 100	-	
		C > 0,55 %	geglüht	190	639	P4	70 - 77 - 84	100 - 110 - 120	-	
		C > 0,55 %	vergütet	300	1013	P5	56 - 63 - 70	80 - 90 - 100	-	
		Automatenstahl (kurzspanend)	geglüht	220	745	P6	70 - 77 - 84	100 - 110 - 120	-	
	Niedrig legierter Stahl		geglüht	175	591	P7	46 - 54 - 63	65 - 78 - 90	-	
			vergütet	300	1013	P8	35 - 42 - 49	50 - 60 - 70	-	
			vergütet	380	1282	P9	30 - 36 - 42	43 - 52 - 60	-	
			vergütet	430	1477	P10	30 - 36 - 42	43 - 52 - 60	-	
	Hochlegierter Stahl und hochlegierter Werkzeugstahl		geglüht	200	675	P11	46 - 54 - 63	65 - 78 - 90	-	
			gehärtet und angelassen	300	1013	P12	35 - 42 - 49	50 - 60 - 70	-	
			gehärtet und angelassen	400	1361	P13	30 - 36 - 42	43 - 52 - 60	-	
	Nichtrostender Stahl		ferritisch / martensitisch, geglüht	200	675	P14	32 - 37 - 42	45 - 53 - 60	-	
			martensitisch, vergütet	330	1114	P15	25 - 30 - 35	35 - 43 - 50	-	
M	Nichtrostender Stahl		austenitisch, abgeschreckt	200	675	M1	32 - 37 - 42	45 - 53 - 60	-	
			austenitisch, ausscheidungsgehärtet (PH)	300	1013	M2	25 - 30 - 35	35 - 43 - 50	-	
			austenitisch-ferritisch, Duplex	230	778	M3	32 - 37 - 42	45 - 53 - 60	-	
K	Temperguss		ferritisch	200	675	K1	63 - 77 - 91	90 - 110 - 130	-	
			perritisch	260	867	K2	49 - 54 - 60	70 - 78 - 85	-	
	Grauguss		niedrige Festigkeit	180	602	K3	63 - 77 - 91	90 - 110 - 130	-	
			hohe Festigkeit / austenitisch	245	825	K4	49 - 54 - 60	70 - 78 - 85	-	
	Gusseisen mit Kugelgraphit		ferritisch	155	518	K5	63 - 77 - 91	90 - 110 - 130	-	
			perritisch	265	885	K6	49 - 54 - 60	70 - 78 - 85	-	
	GGV (CGI)		200	675	K7	63 - 77 - 91	90 - 110 - 130	-		
N	Aluminium-Knetlegierungen		nicht aushärtbar	30	-	N1	50 - 60 - 70	-	140 - 260 - 380	
			aushärtbar, ausgehärtet	100	343	N2	50 - 60 - 70	-	141 - 260 - 380	
	Aluminium-Gusslegierungen		≤ 12 % Si, nicht aushärtbar	75	260	N3	50 - 60 - 70	-	120 - 210 - 300	
			≤ 12 % Si, aushärtbar, ausgehärtet	90	314	N4	50 - 60 - 70	-	120 - 210 - 300	
		> 12 % Si, nicht aushärtbar	130	447	N5	50 - 60 - 70	-	120 - 180 - 240		
	Magnesiumlegierungen		70	250	N6	-	-	140 - 260 - 380		
	Kupfer und Kupferlegierungen (Bronze / Messing)		unlegiert, Elektrolytkupfer	100	343	N7	49 - 95 - 140	70 - 135 - 200	-	
			Messing, Bronze, Rotguss	90	314	N8	49 - 95 - 140	70 - 135 - 200	120 - 180 - 240	
			Cu-Legierung, kurzspanend	110	382	N9	49 - 95 - 140	70 - 135 - 200	140 - 260 - 380	
			hochfest, Ampco	300	1013	N10	49 - 94 - 140	70 - 135 - 200	120 - 180 - 240	
Nichtmetallische Werkstoffe		Thermoplaste (ohne abrasive Füllstoffe)	-	-	N11	20 - 30 - 40	-	-		
		Duroplaste (ohne abrasive Füllstoffe)	-	-	N12	20 - 30 - 40	-	-		
		Kunststoff glasfaserverstärkt GFRP	-	-	N13	-	-	-		
		Kunststoff kohlefaserverstärkt CFRP	-	-	N14	-	-	-		
		Kunststoff aramidfaserverstärkt AFRP	-	-	N15	-	-	-		
		Graphit (technisch)	80 Shore	-	N16	-	-	-		
S	Warmfeste Legierungen		Fe-Basis	geglüht	200	675	S1	11 - 17 - 23	15 - 24 - 33	-
				ausgehärtet	280	943	S2	11 - 17 - 23	15 - 24 - 33	-
				geglüht	250	839	S3	11 - 17 - 23	15 - 24 - 33	-
			Ni- oder Co-Basis	ausgehärtet	350	1177	S4	11 - 17 - 23	15 - 24 - 33	-
				gegossen	320	1076	S5	11 - 17 - 23	15 - 24 - 33	-
	Titanlegierungen		Reintitan	200	675	S6	11 - 19 - 27	15 - 24 - 33	-	
			α- und β-Legierungen, ausgehärtet	375	1262	S7	11 - 19 - 27	15 - 24 - 33	-	
			β-Legierungen	410	1396	S8	11 - 19 - 27	15 - 24 - 33	-	
		Wolframlegierungen		300	1013	S9	-	-	-	
		Molybdänlegierungen		300	1013	S10	-	-	-	
H	Gehärteter Stahl		gehärtet und angelassen	50 HRC	-	H1	-	-	-	
			gehärtet und angelassen	55 HRC	-	H2	-	-	-	
			gehärtet und angelassen	60 HRC	-	H3	-	-	-	
		Gehärtetes Gusseisen	gehärtet und angelassen	55 HRC	-	H4	-	-	-	

Die Tabellenwerte sind Richtwerte. Es kann notwendig sein, die Werte den jeweiligen Bearbeitungsumständen anzupassen.

		Vorschub pro Umdrehung fn (mm/U)					
PM-HSS TiAlN	Ø	1 - 3 mm	3 - 5 mm	5 - 8 mm	8 - 10 mm	10 - 12 mm	12 - 14 mm
		40 - 50 - 60	0,04 - 0,06 - 0,07	0,07 - 0,10 - 0,13	0,11 - 0,15 - 0,18	0,13 - 0,17 - 0,20	0,14 - 0,18 - 0,21
40 - 50 - 60	0,04 - 0,06 - 0,07	0,07 - 0,10 - 0,13	0,11 - 0,15 - 0,18	0,13 - 0,17 - 0,20	0,14 - 0,18 - 0,21	0,14 - 0,20 - 0,25	
40 - 50 - 60	0,04 - 0,06 - 0,07	0,07 - 0,10 - 0,13	0,11 - 0,15 - 0,18	0,13 - 0,17 - 0,20	0,14 - 0,18 - 0,21	0,14 - 0,20 - 0,25	
40 - 50 - 60	0,04 - 0,06 - 0,07	0,07 - 0,10 - 0,13	0,11 - 0,15 - 0,18	0,13 - 0,17 - 0,20	0,14 - 0,18 - 0,21	0,14 - 0,20 - 0,25	
30 - 34 - 38	0,04 - 0,06 - 0,07	0,07 - 0,10 - 0,13	0,11 - 0,15 - 0,18	0,13 - 0,17 - 0,20	0,14 - 0,18 - 0,21	0,14 - 0,20 - 0,25	
40 - 50 - 60	0,04 - 0,06 - 0,07	0,07 - 0,10 - 0,13	0,11 - 0,15 - 0,18	0,13 - 0,17 - 0,20	0,14 - 0,18 - 0,21	0,14 - 0,20 - 0,25	
40 - 50 - 60	0,04 - 0,08 - 0,11	0,07 - 0,11 - 0,14	0,11 - 0,15 - 0,18	0,13 - 0,17 - 0,20	0,13 - 0,19 - 0,25	0,14 - 0,20 - 0,25	
30 - 34 - 38	0,04 - 0,06 - 0,08	0,06 - 0,09 - 0,11	0,07 - 0,10 - 0,13	0,10 - 0,13 - 0,14	0,11 - 0,15 - 0,18	0,11 - 0,16 - 0,21	
30 - 34 - 38	0,04 - 0,06 - 0,08	0,06 - 0,09 - 0,11	0,07 - 0,10 - 0,13	0,08 - 0,11 - 0,14	0,11 - 0,15 - 0,18	0,11 - 0,16 - 0,21	
30 - 34 - 38	0,04 - 0,06 - 0,08	0,06 - 0,09 - 0,11	0,07 - 0,10 - 0,13	0,08 - 0,11 - 0,14	0,11 - 0,15 - 0,18	0,11 - 0,16 - 0,21	
30 - 34 - 38	0,04 - 0,08 - 0,11	0,07 - 0,11 - 0,14	0,11 - 0,15 - 0,18	0,13 - 0,17 - 0,21	0,13 - 0,19 - 0,25	0,14 - 0,20 - 0,25	
30 - 34 - 38	0,04 - 0,06 - 0,07	0,06 - 0,09 - 0,11	0,07 - 0,10 - 0,13	0,08 - 0,11 - 0,14	0,11 - 0,15 - 0,18	0,11 - 0,16 - 0,21	
30 - 34 - 38	0,04 - 0,06 - 0,07	0,06 - 0,09 - 0,11	0,07 - 0,10 - 0,13	0,08 - 0,11 - 0,14	0,11 - 0,15 - 0,18	0,11 - 0,16 - 0,21	
20 - 23 - 25	0,01 - 0,04 - 0,06	0,03 - 0,05 - 0,07	0,04 - 0,06 - 0,08	0,06 - 0,08 - 0,13	0,07 - 0,11 - 0,14	0,07 - 0,11 - 0,14	
10 - 13 - 15	0,01 - 0,04 - 0,06	0,03 - 0,05 - 0,07	0,04 - 0,06 - 0,08	0,07 - 0,10 - 0,13	0,07 - 0,11 - 0,14	0,07 - 0,11 - 0,14	
20 - 23 - 25	0,01 - 0,04 - 0,06	0,03 - 0,05 - 0,07	0,04 - 0,06 - 0,08	0,07 - 0,10 - 0,13	0,07 - 0,11 - 0,14	0,07 - 0,11 - 0,14	
10 - 13 - 15	0,01 - 0,04 - 0,06	0,03 - 0,05 - 0,07	0,04 - 0,06 - 0,08	0,07 - 0,10 - 0,13	0,07 - 0,11 - 0,14	0,07 - 0,11 - 0,14	
20 - 23 - 25	0,01 - 0,04 - 0,06	0,03 - 0,05 - 0,07	0,04 - 0,06 - 0,08	0,07 - 0,10 - 0,13	0,07 - 0,11 - 0,14	0,07 - 0,11 - 0,14	
55 - 63 - 70	0,06 - 0,07 - 0,07	0,08 - 0,10 - 0,11	0,11 - 0,17 - 0,23	0,14 - 0,21 - 0,28	0,18 - 0,25 - 0,32	0,21 - 0,28 - 0,35	
45 - 55 - 65	0,06 - 0,07 - 0,07	0,07 - 0,09 - 0,11	0,08 - 0,15 - 0,21	0,14 - 0,20 - 0,25	0,14 - 0,21 - 0,28	0,18 - 0,23 - 0,28	
55 - 63 - 70	0,06 - 0,07 - 0,07	0,08 - 0,10 - 0,11	0,11 - 0,17 - 0,23	0,14 - 0,21 - 0,28	0,18 - 0,25 - 0,32	0,21 - 0,28 - 0,35	
45 - 55 - 65	0,06 - 0,07 - 0,07	0,07 - 0,09 - 0,11	0,08 - 0,15 - 0,21	0,14 - 0,20 - 0,25	0,14 - 0,21 - 0,28	0,18 - 0,23 - 0,28	
55 - 63 - 70	0,06 - 0,07 - 0,07	0,08 - 0,10 - 0,11	0,11 - 0,17 - 0,23	0,14 - 0,21 - 0,28	0,18 - 0,25 - 0,32	0,21 - 0,28 - 0,35	
45 - 55 - 65	0,06 - 0,07 - 0,07	0,07 - 0,09 - 0,11	0,08 - 0,15 - 0,21	0,14 - 0,20 - 0,25	0,14 - 0,21 - 0,28	0,18 - 0,23 - 0,28	
55 - 63 - 70	0,06 - 0,07 - 0,07	0,08 - 0,10 - 0,11	0,11 - 0,17 - 0,23	0,14 - 0,21 - 0,28	0,18 - 0,25 - 0,32	0,21 - 0,28 - 0,35	
-	0,08 - 0,11 - 0,13	0,12 - 0,14 - 0,16	0,15 - 0,18 - 0,20	0,20 - 0,22 - 0,24	0,26 - 0,28 - 0,30	0,30 - 0,32 - 0,34	
-	0,08 - 0,11 - 0,13	0,12 - 0,14 - 0,16	0,15 - 0,18 - 0,20	0,20 - 0,22 - 0,24	0,26 - 0,28 - 0,30	0,30 - 0,32 - 0,34	
-	0,08 - 0,11 - 0,13	0,12 - 0,14 - 0,16	0,15 - 0,18 - 0,20	0,20 - 0,22 - 0,24	0,26 - 0,28 - 0,30	0,30 - 0,32 - 0,34	
-	0,08 - 0,11 - 0,13	0,12 - 0,14 - 0,16	0,15 - 0,18 - 0,20	0,20 - 0,22 - 0,24	0,26 - 0,28 - 0,30	0,30 - 0,32 - 0,34	
-	0,08 - 0,11 - 0,13	0,12 - 0,14 - 0,16	0,15 - 0,18 - 0,20	0,20 - 0,22 - 0,24	0,26 - 0,28 - 0,30	0,30 - 0,32 - 0,34	
-	0,01 - 0,06 - 0,11	0,04 - 0,09 - 0,13	0,07 - 0,11 - 0,14	0,13 - 0,17 - 0,21	0,18 - 0,22 - 0,25	0,21 - 0,24 - 0,27	
-	0,08 - 0,11 - 0,13	0,12 - 0,14 - 0,16	0,15 - 0,18 - 0,22	0,20 - 0,22 - 0,24	0,26 - 0,28 - 0,30	0,30 - 0,32 - 0,34	
-	0,08 - 0,11 - 0,13	0,12 - 0,14 - 0,16	0,15 - 0,18 - 0,23	0,20 - 0,22 - 0,24	0,26 - 0,28 - 0,30	0,30 - 0,32 - 0,34	
-	0,06 - 0,09 - 0,11	0,09 - 0,11 - 0,13	0,09 - 0,11 - 0,13	0,12 - 0,14 - 0,16	0,16 - 0,18 - 0,20	0,20 - 0,22 - 0,24	
-	0,01 - 0,03 - 0,04	0,04 - 0,05 - 0,06	0,06 - 0,08 - 0,09	0,08 - 0,10 - 0,11	0,09 - 0,11 - 0,12	0,11 - 0,12 - 0,13	
-	0,01 - 0,03 - 0,04	0,04 - 0,05 - 0,06	0,06 - 0,08 - 0,09	0,08 - 0,10 - 0,11	0,09 - 0,11 - 0,12	0,11 - 0,12 - 0,13	
-	-	-	-	-	-	-	
-	-	-	-	-	-	-	
-	-	-	-	-	-	-	
-	-	-	-	-	-	-	
-	0,01 - 0,03 - 0,04	0,02 - 0,04 - 0,05	0,03 - 0,05 - 0,06	0,04 - 0,06 - 0,07	0,06 - 0,07 - 0,08	0,06 - 0,08 - 0,10	
-	0,01 - 0,03 - 0,04	0,02 - 0,04 - 0,05	0,03 - 0,05 - 0,06	0,04 - 0,06 - 0,07	0,06 - 0,07 - 0,08	0,06 - 0,08 - 0,10	
6 - 9 - 12	0,01 - 0,03 - 0,04	0,02 - 0,04 - 0,05	0,03 - 0,05 - 0,06	0,04 - 0,06 - 0,07	0,06 - 0,07 - 0,08	0,06 - 0,08 - 0,10	
6 - 9 - 12	0,01 - 0,03 - 0,04	0,02 - 0,04 - 0,05	0,03 - 0,05 - 0,06	0,04 - 0,06 - 0,07	0,06 - 0,07 - 0,08	0,06 - 0,08 - 0,10	
6 - 9 - 12	0,01 - 0,03 - 0,04	0,02 - 0,04 - 0,05	0,03 - 0,05 - 0,06	0,04 - 0,06 - 0,07	0,06 - 0,07 - 0,08	0,06 - 0,08 - 0,10	
7 - 9 - 11	0,01 - 0,02 - 0,03	0,02 - 0,04 - 0,05	0,04 - 0,06 - 0,08	0,04 - 0,06 - 0,08	0,06 - 0,09 - 0,11	0,06 - 0,09 - 0,11	
7 - 9 - 11	0,01 - 0,02 - 0,03	0,02 - 0,04 - 0,05	0,04 - 0,06 - 0,08	0,04 - 0,06 - 0,08	0,06 - 0,09 - 0,11	0,06 - 0,09 - 0,11	
7 - 9 - 11	0,01 - 0,02 - 0,03	0,02 - 0,04 - 0,05	0,04 - 0,06 - 0,08	0,04 - 0,06 - 0,08	0,06 - 0,09 - 0,11	0,06 - 0,09 - 0,11	
-	-	-	-	-	-	-	
-	-	-	-	-	-	-	
-	-	-	-	-	-	-	
-	-	-	-	-	-	-	
-	-	-	-	-	-	-	

Material group	Structure of the material groups and identification letters		Brinell hardness HB	Tensile strength Rm (N/mm <sup>2</sup> )	Chipping group	Cutting speed V <sub>c</sub> (m/min)		
						VHM uncoated	VHM TiAlN	VHM diamond
P	Unalloyed steel	C ≤ 0.25 % annealed	125	428	P1	70 - 77 - 84	100 - 110 - 120	-
		C > 0.25 ... ≤ 0.55 % annealed	190	639	P2	70 - 77 - 84	100 - 110 - 120	-
		C > 0.25 ... ≤ 0.55 % hardened and tempered	210	708	P3	56 - 63 - 70	80 - 90 - 100	-
		C > 0.55 % annealed	190	639	P4	70 - 77 - 84	100 - 110 - 120	-
		C > 0.55 % hardened and tempered	300	1013	P5	56 - 63 - 70	80 - 90 - 100	-
		Machining steel (short-chipping) tempered	220	745	P6	70 - 77 - 84	100 - 110 - 120	-
	Low alloyed steel	annealed	175	591	P7	46 - 54 - 63	65 - 78 - 90	-
		hardened and tempered	300	1013	P8	35 - 42 - 49	50 - 60 - 70	-
		hardened and tempered	380	1282	P9	30 - 36 - 42	43 - 52 - 60	-
		hardened and tempered	430	1477	P10	30 - 36 - 42	43 - 52 - 60	-
	High alloyed steel and high alloyed tool steel	annealed	200	675	P11	46 - 54 - 63	65 - 78 - 90	-
		hardened	300	1013	P12	35 - 42 - 49	50 - 60 - 70	-
		hardened	400	1361	P13	30 - 36 - 42	43 - 52 - 60	-
	Stainless steel	ferritic / martensitic, annealed	200	675	P14	32 - 37 - 42	45 - 53 - 60	-
		martensitic, hardened and tempered	330	1114	P15	25 - 30 - 35	35 - 43 - 50	-
M	Stainless steel	austenitic, chilled	200	675	M1	32 - 37 - 42	45 - 53 - 60	-
		austenitic, precipitation-hardened (PH)	300	1013	M2	25 - 30 - 35	35 - 43 - 50	-
		austenitic-ferritic, Duplex	230	778	M3	32 - 37 - 42	45 - 53 - 60	-
K	Malleable cast iron	ferritic	200	675	K1	63 - 77 - 91	90 - 110 - 130	-
		pearlitic	260	867	K2	49 - 54 - 60	70 - 78 - 85	-
	Cast iron	low tensile strength	180	602	K3	63 - 77 - 91	90 - 110 - 130	-
		high tensile strength / austenitic	245	825	K4	49 - 54 - 60	70 - 78 - 85	-
	Cast iron with nodular graphite	ferritic	155	518	K5	63 - 77 - 91	90 - 110 - 130	-
		pearlitic	265	885	K6	49 - 54 - 60	70 - 78 - 85	-
GGV (CGI)		200	675	K7	63 - 77 - 91	90 - 110 - 130	-	
N	Aluminium alloys long chipping	not heat treatable	30	-	N1	50 - 60 - 70	-	140 - 260 - 380
		heat treatable, heat treated	100	343	N2	50 - 60 - 70	-	141 - 260 - 380
	Casted aluminium alloys	≤ 12 % Si, not heat treatable	75	260	N3	50 - 60 - 70	-	120 - 210 - 300
		≤ 12 % Si, aushärtbar, ausgehärtet	90	314	N4	50 - 60 - 70	-	120 - 210 - 300
		> 12 % Si, not heat treatable	130	447	N5	50 - 60 - 70	-	120 - 180 - 240
	Magnesium alloys		70	250	N6	-	-	140 - 260 - 380
	Copper and copper alloys (Brass / Bronze)	Unalloyed, elektrolyte copper	100	343	N7	49 - 95 - 140	70 - 135 - 200	-
		Brass, Bronze	90	314	N8	49 - 95 - 140	70 - 135 - 200	120 - 180 - 240
		Cu-alloys, short-chipping	110	382	N9	49 - 95 - 140	70 - 135 - 200	140 - 260 - 380
		High-tensile, Ampco	300	1013	N10	49 - 94 - 140	70 - 135 - 200	120 - 180 - 240
	Non-ferrous materials	Lead alloys (without abrasive filling material)	-	-	N11	20 - 30 - 40	-	-
Duroplastic (without abrasive filling material)		-	-	N12	20 - 30 - 40	-	-	
Plastic glas fibre reinforced GFRP		-	-	N13	-	-	-	
Plastic carbon fibre reinforced CFRP		-	-	N14	-	-	-	
Plastic aramid fibre reinforced AFRP		-	-	N15	-	-	-	
Graphite (tech.)		80 Shore	-	N16	-	-	-	
S	High temperature resistant alloys	Fe-Basis annealed	200	675	S1	11 - 17 - 23	15 - 24 - 33	-
		Fe-Basis heat treated	280	943	S2	11 - 17 - 23	15 - 24 - 33	-
		Ni- or Co-alloyed annealed	250	839	S3	11 - 17 - 23	15 - 24 - 33	-
		Ni- or Co-alloyed heat treated	350	1177	S4	11 - 17 - 23	15 - 24 - 33	-
		Ni- or Co-alloyed casting	320	1076	S5	11 - 17 - 23	15 - 24 - 33	-
	Titanium alloys	Pure titan	200	675	S6	11 - 19 - 27	15 - 24 - 33	-
		α- and β-alloys, heat treated	375	1262	S7	11 - 19 - 27	15 - 24 - 33	-
		β-alloys	410	1396	S8	11 - 19 - 27	15 - 24 - 33	-
	Wolfram alloys		300	1013	S9	-	-	-
	Molybdän alloys		300	1013	S10	-	-	-
H	Hardened steel	hardened	50 HRC	-	H1	-	-	-
		hardened	55 HRC	-	H2	-	-	-
		hardened	60 HRC	-	H3	-	-	-
	Hardened cast iron	hardened	55 HRC	-	H4	-	-	-

The recommended cutting data are only approximate values. It may be necessary to adjust them to each individual machining application.





# Tableaux des avances valeurs de coupe recommandées ≤ 10xD

ISO	Matériaux		Dureté Brinell	Résistance (N/mm <sup>2</sup> )	Groupe d'usinage	Vitesse de coupe Vc (m/min)		
						VHM sans revêtement	VHM TAIN	VHM diamant
P	Acier non allié	C ≤ 0,25 % recuit	125	428	P1	70 - 77 - 84	100 - 110 - 120	-
		C > 0,25 ... ≤ 0,55 % recuit	190	639	P2	70 - 77 - 84	100 - 110 - 120	-
		C > 0,25 ... ≤ 0,55 % traité	210	708	P3	56 - 63 - 70	80 - 90 - 100	-
		C > 0,55 % recuit	190	639	P4	70 - 77 - 84	100 - 110 - 120	-
		C > 0,55 % traité	300	1013	P5	56 - 63 - 70	80 - 90 - 100	-
		Aciers de décolletage (à copeaux courts) recuit	220	745	P6	70 - 77 - 84	100 - 110 - 120	-
	Acier faiblement allié	recuit	175	591	P7	46 - 54 - 63	65 - 78 - 90	-
		traité	300	1013	P8	35 - 42 - 49	50 - 60 - 70	-
		traité	380	1282	P9	30 - 36 - 42	43 - 52 - 60	-
		traité	430	1477	P10	30 - 36 - 42	43 - 52 - 60	-
	Acier allié et acier outil allié	recuit	200	675	P11	46 - 54 - 63	65 - 78 - 90	-
		trempe et revenu	300	1013	P12	35 - 42 - 49	50 - 60 - 70	-
		trempe et revenu	400	1361	P13	30 - 36 - 42	43 - 52 - 60	-
	Acier inox	ferritique, martensitique, recuit	200	675	P14	32 - 37 - 42	45 - 53 - 60	-
		martensitique, traité	330	1114	P15	25 - 30 - 35	35 - 43 - 50	-
M	Acier inox	austénitique	200	675	M1	32 - 37 - 42	45 - 53 - 60	-
		austénitique	300	1013	M2	25 - 30 - 35	35 - 43 - 50	-
		austénitique-ferritique, Duplex	230	778	M3	32 - 37 - 42	45 - 53 - 60	-
K	Fonte malléable	ferritique	200	675	K1	63 - 77 - 91	90 - 110 - 130	-
		perlitique	260	867	K2	49 - 54 - 60	70 - 78 - 85	-
	Fonte grise	faible résistance	180	602	K3	63 - 77 - 91	90 - 110 - 130	-
		haute résistance / austénitique	245	825	K4	49 - 54 - 60	70 - 78 - 85	-
	Fonte à Graphite sphéroïdale	ferritique	155	518	K5	63 - 77 - 91	90 - 110 - 130	-
		perlitique	265	885	K6	49 - 54 - 60	70 - 78 - 85	-
GGV (CGI)		200	675	K7	63 - 77 - 91	90 - 110 - 130	-	
N	Alliages de fonderie d'aluminium	ne pouvant pas subir un durcissement	30	-	N1	50 - 60 - 70	-	140 - 260 - 380
		pouvant subir un durcissement, durci	100	343	N2	50 - 60 - 70	-	141 - 260 - 380
	Alliage de fonte d'aluminium	≤ 12 % Si, ne pouvant pas subir de durcissement	75	260	N3	50 - 60 - 70	-	120 - 210 - 300
		≤ 12 % Si, pouvant subir un durcissement, durci	90	314	N4	50 - 60 - 70	-	120 - 210 - 300
	Alliage de Magnésium	> 12 % Si, ne pouvant pas subir de durcissement	130	447	N5	50 - 60 - 70	-	120 - 180 - 240
			70	250	N6	-	-	140 - 260 - 380
	Cuivre et alliage de cuivre (bronze / laiton)	non allié, cuivre électrolytique	100	343	N7	49 - 95 - 140	70 - 135 - 200	-
		Laiton, bronze, fonte rouge	90	314	N8	49 - 95 - 140	70 - 135 - 200	120 - 180 - 240
		Alliage de cuivre à copeaux courts	110	382	N9	49 - 95 - 140	70 - 135 - 200	140 - 260 - 380
		forte résistance, Ampco	300	1013	N10	49 - 94 - 140	70 - 135 - 200	120 - 180 - 240
Matériaux non métalliques	Thermoplaste (sans agents de charge abrasives)	-	-	N11	20 - 30 - 40	-	-	
	Duroplaste (sans agents de charge abrasives)	-	-	N12	20 - 30 - 40	-	-	
	Matière plastique renforcée de fibres de verre GFRP	-	-	N13	-	-	-	
	Matière plastique renforcé composite CFRP	-	-	N14	-	-	-	
	Plastique renforcé fibre aramide AFRP	-	-	N15	-	-	-	
	Graphite	80 Shore	-	N16	-	-	-	
S	Alliages réfractaires	à base de Fe recuit	200	675	S1	11 - 17 - 23	15 - 24 - 33	-
		durci	280	943	S2	11 - 17 - 23	15 - 24 - 33	-
		recuit	250	839	S3	11 - 17 - 23	15 - 24 - 33	-
		à base Ni ou Co durci	350	1177	S4	11 - 17 - 23	15 - 24 - 33	-
		jeter	320	1076	S5	11 - 17 - 23	15 - 24 - 33	-
	Alliage de titane	Titane pur	200	675	S6	11 - 19 - 27	15 - 24 - 33	-
		Alliages Alpha + Beta, trempé	375	1262	S7	11 - 19 - 27	15 - 24 - 33	-
		Alliages Beta	410	1396	S8	11 - 19 - 27	15 - 24 - 33	-
	Alliage de tungstène		300	1013	S9	-	-	-
	Alliage de molybdène		300	1013	S10	-	-	-
H	Acier trempé	trempe et revenu	50 HRC	-	H1	-	-	-
		trempe et revenu	55 HRC	-	H2	-	-	-
		trempe et revenu	60 HRC	-	H3	-	-	-
	Fonte durci	trempe et revenu	55 HRC	-	H4	-	-	-

Les valeurs du tableau sont indicatives. Il peut être nécessaire de les adapter aux conditions d'usinage respectives.



Werkstoff- gruppe	Gliederung der Werkstoffhauptgruppen und Kennbuchstaben		Brinell-Härte	Zugfestigkeit Rm (N/mm <sup>2</sup> )	Zerspanungsgruppe	Schnittgeschwindigkeit V <sub>c</sub> (m/min)		
						VHM	TAIN	
<b>P</b>	Unlegierter Stahl	C ≤ 0,25 %	geglüht	125	428	P1	90 - 100 - 110	
		C > 0,25 ... ≤ 0,55 %	geglüht	190	639	P2	75 - 88 - 100	
		C > 0,25 ... ≤ 0,55 %	vergütet	210	708	P3	75 - 88 - 100	
		C > 0,55 %	geglüht	190	639	P4	75 - 88 - 100	
		C > 0,55 %	vergütet	300	1013	P5	75 - 85 - 95	
		Automatenstahl (kurzspanend)	geglüht	220	745	P6	75 - 88 - 100	
	Niedrig legierter Stahl		geglüht	175	591	P7	70 - 83 - 95	
			vergütet	300	1013	P8	70 - 83 - 95	
			vergütet	380	1282	P9	55 - 65 - 75	
			vergütet	430	1477	P10	55 - 65 - 75	
	Hochlegierter Stahl und hochlegierter Werkzeugstahl		geglüht	200	675	P11	70 - 83 - 95	
			gehärtet und angelassen	300	1013	P12	70 - 83 - 95	
			gehärtet und angelassen	400	1361	P13	55 - 65 - 75	
	Nichtrostender Stahl		ferritisch / martensitisch, geglüht	200	675	P14	70 - 73 - 75	
			martensitisch, vergütet	330	1114	P15	45 - 53 - 60	
<b>M</b>	Nichtrostender Stahl		austenitisch, abgeschreckt	200	675	M1	50 - 58 - 65	
			austenitisch, ausscheidungsgehärtet (PH)	300	1013	M2	35 - 43 - 50	
			austenitisch-ferritisch, Duplex	230	778	M3	45 - 53 - 60	
<b>K</b>	Temperguss		ferritisch	200	675	K1	80 - 93 - 105	
			perritisch	260	867	K2	75 - 88 - 100	
	Grauguss		niedrige Festigkeit	180	602	K3	85 - 95 - 105	
			hohe Festigkeit / austenitisch	245	825	K4	75 - 88 - 100	
	Gusseisen mit Kugelgraphit		ferritisch	155	518	K5	80 - 93 - 105	
			perritisch	265	885	K6	75 - 88 - 100	
	GGV (CGI)			200	675	K7	80 - 93 - 105	
<b>N</b>	Aluminium-Knetlegierungen		nicht aushärtbar	30	-	N1	-	
			aushärtbar, ausgehärtet	100	343	N2	-	
	Aluminium-Gusslegierungen		≤ 12 % Si, nicht aushärtbar	75	260	N3	-	
			≤ 12 % Si, aushärtbar, ausgehärtet	90	314	N4	-	
	Magnesiumlegierungen		> 12 % Si, nicht aushärtbar	130	447	N5	-	
				70	250	N6	-	
	Kupfer und Kupferlegierungen (Bronze / Messing)		unlegiert, Elektrolytkupfer	100	343	N7	-	
			Messing, Bronze, Rotguss	90	314	N8	-	
			Cu-Legierung, kurzspanend	110	382	N9	-	
			hochfest, Ampco	300	1013	N10	-	
Nichtmetallische Werkstoffe		Thermoplaste (ohne abrasive Füllstoffe)	-	-	N11	-		
		Duroplaste (ohne abrasive Füllstoffe)	-	-	N12	-		
		Kunststoff glasfaserverstärkt GFRP	-	-	N13	-		
		Kunststoff kohlefaserverstärkt CFRP	-	-	N14	-		
		Kunststoff aramidfaserverstärkt AFRP	-	-	N15	-		
		Graphit (technisch)	80 Shore	-	N16	-		
<b>S</b>	Warmfeste Legierungen		Fe-Basis	geglüht	200	675	S1	-
				ausgehärtet	280	943	S2	-
				geglüht	250	839	S3	-
			Ni- oder Co-Basis	ausgehärtet	350	1177	S4	-
				gegossen	320	1076	S5	-
	Titanlegierungen		Reintitan	200	675	S6	-	
			α- und β-Legierungen, ausgehärtet	375	1262	S7	-	
			β-Legierungen	410	1396	S8	-	
	Wolframlegierungen			300	1013	S9	-	
	Molybdänlegierungen			300	1013	S10	-	
<b>H</b>	Gehärteter Stahl		gehärtet und angelassen	50 HRC	-	H1	-	
			gehärtet und angelassen	55 HRC	-	H2	-	
			gehärtet und angelassen	60 HRC	-	H3	-	
	Gehärtetes Gusseisen		gehärtet und angelassen	55 HRC	-	H4	-	

Die Tabellenwerte sind Richtwerte. Es kann notwendig sein, die Werte den jeweiligen Bearbeitungsumständen anzupassen.



Material group	Structure of the material groups and identification letters		Brinell hardness HB	Tensile strength Rm (N/mm <sup>2</sup> )	Chipping group	Cutting speed V <sub>c</sub> (m/min)	
						VHM	TAIN
P	Unalloyed steel	C ≤ 0.25 % annealed	125	428	P1	90 - 100 - 110	
		C > 0.25 ... ≤ 0.55 % annealed	190	639	P2	75 - 88 - 100	
		C > 0.25 ... ≤ 0.55 % hardened and tempered	210	708	P3	75 - 88 - 100	
		C > 0.55 % annealed	190	639	P4	75 - 88 - 100	
		C > 0.55 % hardened and tempered	300	1013	P5	75 - 85 - 95	
		Machining steel (short-chipping) tempered	220	745	P6	75 - 88 - 100	
	Low alloyed steel	annealed	175	591	P7	70 - 83 - 95	
		hardened and tempered	300	1013	P8	70 - 83 - 95	
		hardened and tempered	380	1282	P9	55 - 65 - 75	
		hardened and tempered	430	1477	P10	55 - 65 - 75	
	High alloyed steel and high alloyed tool steel	annealed	200	675	P11	70 - 83 - 95	
		hardened	300	1013	P12	70 - 83 - 95	
		hardened	400	1361	P13	55 - 65 - 75	
	Stainless steel	ferritic / martensitic, annealed	200	675	P14	70 - 73 - 75	
		martensitic, hardened and tempered	330	1114	P15	45 - 53 - 60	
M	Stainless steel	austenitic, chilled	200	675	M1	50 - 58 - 65	
		austenitic, precipitation-hardened (PH)	300	1013	M2	35 - 43 - 50	
		austenitic-ferritic, Duplex	230	778	M3	45 - 53 - 60	
K	Malleable cast iron	ferritic	200	675	K1	80 - 93 - 105	
		pearlitic	260	867	K2	75 - 88 - 100	
	Cast iron	low tensile strength	180	602	K3	85 - 95 - 105	
		high tensile strength / austenitic	245	825	K4	75 - 88 - 100	
	Cast iron with nodular graphite	ferritic	155	518	K5	80 - 93 - 105	
		pearlitic	265	885	K6	75 - 88 - 100	
	GGV (CGI)		200	675	K7	80 - 93 - 105	
N	Aluminium alloys long chipping	not heat treatable	30	-	N1	-	
		heat treatable, heat treated	100	343	N2	-	
		≤ 12 % Si, not heat treatable	75	260	N3	-	
	Casted aluminium alloys	≤ 12 % Si, aushärtbar, ausgehärtet	90	314	N4	-	
		> 12 % Si, not heat treatable	130	447	N5	-	
	Magnesium alloys		70	250	N6	-	
	Copper and copper alloys (Brass / Bronze)	Unalloyed, elektrolyte copper	100	343	N7	-	
		Brass, Bronze	90	314	N8	-	
		Cu-alloys, short-chipping	110	382	N9	-	
		High-tensile, Ampco	300	1013	N10	-	
Non-ferrous materials	Lead alloys (without abrasive filling material)	-	-	N11	-		
	Duroplastic (without abrasive filling material)	-	-	N12	-		
	Plastic glas fibre reinforced GFRP	-	-	N13	-		
	Plastic carbon fibre reinforced CFRP	-	-	N14	-		
	Plastic aramid fibre reinforced AFRP	-	-	N15	-		
	Graphite (tech.)	80 Shore	-	N16	-		
S	High temperature resistant alloys	Fe-Basis annealed	200	675	S1	-	
		Fe-Basis heat treated	280	943	S2	-	
		Ni- or Co-alloyed annealed	250	839	S3	-	
		Ni- or Co-alloyed heat treated	350	1177	S4	-	
		Ni- or Co-alloyed casting	320	1076	S5	-	
	Titanium alloys	Pure titan	200	675	S6	-	
		α- and β-alloys, heat treated	375	1262	S7	-	
		β-alloys	410	1396	S8	-	
	Wolfram alloys		300	1013	S9	-	
	Molybdän alloys		300	1013	S10	-	
H	Hardened steel	hardened	50 HRC	-	H1	-	
		hardened	55 HRC	-	H2	-	
		hardened	60 HRC	-	H3	-	
	Hardened cast iron	hardened	55 HRC	-	H4	-	

The recommended cutting data are only approximate values. It may be necessary to adjust them to each individual machining application.



# Tableaux des avances valeurs de coupe recommandées > 10xD

ISO	Matériaux		Dureté Brinell	Résistance (N/mm <sup>2</sup> )	Groupe d'usinage	Vitesse de coupe Vc (m/min)	
						VHM	TAIN
P	Acier non allié	C ≤ 0,25 % recuit	125	428	P1	90 - 100 - 110	
		C > 0,25 ... ≤ 0,55 % recuit	190	639	P2	75 - 88 - 100	
		C > 0,25 ... ≤ 0,55 % traité	210	708	P3	75 - 88 - 100	
		C > 0,55 % recuit	190	639	P4	75 - 88 - 100	
		C > 0,55 % traité	300	1013	P5	75 - 85 - 95	
		Aciers de décolletage (à copeaux courts) recuit	220	745	P6	75 - 88 - 100	
	Acier faiblement allié	recuit	175	591	P7	70 - 83 - 95	
		traité	300	1013	P8	70 - 83 - 95	
		traité	380	1282	P9	55 - 65 - 75	
		traité	430	1477	P10	55 - 65 - 75	
	Acier allié et acier outil allié	recuit	200	675	P11	70 - 83 - 95	
		trempe et revenu	300	1013	P12	70 - 83 - 95	
		trempe et revenu	400	1361	P13	55 - 65 - 75	
	Acier inox	ferritique, martensitique, recuit	200	675	P14	70 - 73 - 75	
		martensitique, traité	330	1114	P15	45 - 53 - 60	
M	Acier inox	austénitique	200	675	M1	50 - 58 - 65	
		austénitique	300	1013	M2	35 - 43 - 50	
		austénitique-ferritique, Duplex	230	778	M3	45 - 53 - 60	
K	Fonte malléable	ferritique	200	675	K1	80 - 93 - 105	
		perlitique	260	867	K2	75 - 88 - 100	
	Fonte grise	faible résistance	180	602	K3	85 - 95 - 105	
		haute résistance / austénitique	245	825	K4	75 - 88 - 100	
	Fonte à Graphite sphéroïdale	ferritique	155	518	K5	80 - 93 - 105	
		perlitique	265	885	K6	75 - 88 - 100	
	GGV (CGI)		200	675	K7	80 - 93 - 105	
N	Alliages de fonderie d'aluminium	ne pouvant pas subir un durcissement	30	-	N1	-	
		pouvant subir un durcissement, durci	100	343	N2	-	
		≤ 12 % Si, ne pouvant pas subir de durcissement	75	260	N3	-	
	Alliage de fonte d'aluminium	≤ 12 % Si, pouvant subir un durcissement, durci	90	314	N4	-	
		> 12 % Si, ne pouvant pas subir de durcissement	130	447	N5	-	
	Alliage de Magnésium		70	250	N6	-	
	Cuivre et alliage de cuivre (bronze / laiton)	non allié, cuivre électrolytique	100	343	N7	-	
		Laiton, bronze, fonte rouge	90	314	N8	-	
		Alliage de cuivre à copeaux courts	110	382	N9	-	
		forte résistance, Ampco	300	1013	N10	-	
Matériaux non métalliques	Thermoplaste (sans agents de charge abrasives)	-	-	N11	-		
	Duroplaste (sans agents de charge abrasives)	-	-	N12	-		
	Matière plastique renforcée de fibres de verre GFRP	-	-	N13	-		
	Matière plastique renforcée composite CFRP	-	-	N14	-		
	Plastique renforcé fibre aramide AFRP	-	-	N15	-		
	Graphite	80 Shore	-	N16	-		
S	Alliages réfractaires	à base de Fe recuit	200	675	S1	-	
		à base de Fe durci	280	943	S2	-	
		à base de Fe recuit	250	839	S3	-	
		à base Ni ou Co durci	350	1177	S4	-	
		à base Ni ou Co jeter	320	1076	S5	-	
	Alliage de titane	Titane pur	200	675	S6	-	
		Alliages Alpha + Beta, trempé	375	1262	S7	-	
		Alliages Beta	410	1396	S8	-	
	Alliage de tungstène		300	1013	S9	-	
	Alliage de molybdène		300	1013	S10	-	
H	Acier trempé	trempe et revenu	50 HRC	-	H1	-	
		trempe et revenu	55 HRC	-	H2	-	
		trempe et revenu	60 HRC	-	H3	-	
	Fonte durci	trempe et revenu	55 HRC	-	H4	-	

Les valeurs du tableau sont indicatives. Il peut être nécessaire de les adapter aux conditions d'usinage respectives.





Werkstoff- gruppe	Gliederung der Werkstoffhauptgruppen und Kennbuchstaben		Brinell-Härte	Zugfestigkeit Rm (N/mm <sup>2</sup> )	Zerspanungsgruppe	Schnittgeschwindigkeit V <sub>c</sub> (m/min)			
						VHM TAIN	PM-HSS TAIN		
<b>P</b>	Unlegierter Stahl	C ≤ 0,25 %	geglüht	125	428	P1	40 - 44 - 48	20 - 25 - 30	
		C > 0,25 ... ≤ 0,55 %	geglüht	190	639	P2	40 - 44 - 48	20 - 25 - 30	
		C > 0,25 ... ≤ 0,55 %	vergütet	210	708	P3	40 - 44 - 48	20 - 25 - 30	
		C > 0,55 %	geglüht	190	639	P4	40 - 44 - 48	20 - 25 - 30	
		C > 0,55 %	vergütet	300	1013	P5	35 - 40 - 45	15 - 23 - 30	
		Automatenstahl (kurzspanend)	geglüht	220	745	P6	38 - 42 - 46	25 - 30 - 35	
	Niedrig legierter Stahl		geglüht	175	591	P7	22 - 26 - 30	10 - 15 - 20	
			vergütet	300	1013	P8	18 - 22 - 26	8 - 12 - 16	
			vergütet	380	1282	P9	18 - 22 - 26	8 - 12 - 16	
			vergütet	430	1477	P10	18 - 22 - 26	8 - 12 - 16	
	Hochlegierter Stahl und hochlegierter Werkzeugstahl		geglüht	200	675	P11	18 - 22 - 26	12 - 16 - 20	
			gehärtet und angelassen	300	1013	P12	12 - 16 - 20	-	
			gehärtet und angelassen	400	1361	P13	12 - 16 - 20	-	
	Nichtrostender Stahl		ferritisch / martensitisch, geglüht	200	675	P14	14 - 18 - 22	6 - 10 - 14	
			martensitisch, vergütet	330	1114	P15	8 - 12 - 16	4 - 8 - 12	
<b>M</b>	Nichtrostender Stahl		austenitisch, abgeschreckt	200	675	M1	14 - 18 - 22	6 - 10 - 14	
			austenitisch, ausscheidungsgehärtet (PH)	300	1013	M2	8 - 12 - 16	4 - 8 - 12	
			austenitisch-ferritisch, Duplex	230	778	M3	10 - 15 - 20	2 - 6 - 10	
<b>K</b>	Temperguss		ferritisch	200	675	K1	29 - 33 - 37	21 - 25 - 29	
			perritisch	260	867	K2	24 - 28 - 32	16 - 20 - 24	
	Grauguss		niedrige Festigkeit	180	602	K3	34 - 38 - 42	26 - 30 - 34	
			hohe Festigkeit / austenitisch	245	825	K4	31 - 35 - 39	26 - 30 - 34	
	Gusseisen mit Kugelgraphit		ferritisch	155	518	K5	29 - 33 - 37	20 - 25 - 30	
			perritisch	265	885	K6	24 - 28 - 32	15 - 20 - 25	
GGV (CGI)			200	675	K7	-	-		
<b>N</b>	Aluminium-Knetlegierungen		nicht aushärtbar	30	-	N1	-	-	
			aushärtbar, ausgehärtet	100	343	N2	-	-	
	Aluminium-Gusslegierungen		≤ 12 % Si, nicht aushärtbar	75	260	N3	-	-	
			≤ 12 % Si, aushärtbar, ausgehärtet	90	314	N4	-	-	
			> 12 % Si, nicht aushärtbar	130	447	N5	-	-	
	Magnesiumlegierungen			70	250	N6	70 - 80 - 90	60 - 70 - 80	
	Kupfer und Kupferlegierungen (Bronze / Messing)		unlegiert, Elektrolytkupfer	100	343	N7	65 - 70 - 75	55 - 60 - 65	
			Messing, Bronze, Rotguss	90	314	N8	70 - 75 - 80	55 - 60 - 65	
			Cu-Legierung, kurzspanend	110	382	N9	40 - 45 - 50	25 - 30 - 35	
			hochfest, Ampco	300	1013	N10	15 - 20 - 25	8 - 12 - 16	
Nichtmetallische Werkstoffe		Thermoplaste (ohne abrasive Füllstoffe)	-	-	N11	20 - 25 - 30	14 - 18 - 22		
		Duroplaste (ohne abrasive Füllstoffe)	-	-	N12	35 - 40 - 45	24 - 28 - 32		
		Kunststoff glasfaserverstärkt GFRP	-	-	N13	-	-		
		Kunststoff kohlefaserverstärkt CFRP	-	-	N14	-	-		
		Kunststoff aramidfaserverstärkt AFRP	-	-	N15	-	-		
		Graphit (technisch)	80 Shore	-	N16	-	-		
<b>S</b>	Warmfeste Legierungen	Fe-Basis	geglüht	200	675	S1	4 - 7 - 10	-	
			ausgehärtet	280	943	S2	4 - 7 - 10	-	
		Ni- oder Co-Basis	geglüht	250	839	S3	4 - 7 - 10	-	
			ausgehärtet	350	1177	S4	4 - 7 - 10	-	
			gegossen	320	1076	S5	4 - 7 - 10	-	
	Titanlegierungen		Reintitan	200	675	S6	7 - 10 - 13	-	
			α- und β-Legierungen, ausgehärtet	375	1262	S7	5 - 8 - 11	-	
			β-Legierungen	410	1396	S8	5 - 8 - 11	-	
	Wolframlegierungen			300	1013	S9	-	-	
	Molybdänlegierungen			300	1013	S10	-	-	
<b>H</b>	Gehärteter Stahl		gehärtet und angelassen	50 HRC	-	H1	-	-	
			gehärtet und angelassen	55 HRC	-	H2	-	-	
			gehärtet und angelassen	60 HRC	-	H3	-	-	
	Gehärtetes Gusseisen		gehärtet und angelassen	55 HRC	-	H4	-	-	

Die Tabellenwerte sind Richtwerte. Es kann notwendig sein, die Werte den jeweiligen Bearbeitungsumständen anzupassen.



# Recommended cutting data Solid carbide end-mill – NC spot drills

Material group	Structure of the material groups and identification letters		Brinell hardness HB	Tensile strength Rm (N/mm <sup>2</sup> )	Chipping group	Cutting speed V <sub>c</sub> (m/min)			
						VHM TAIN	PM-HSS TAIN		
P	Unalloyed steel	C ≤ 0.25 % annealed	125	428	P1	40 - 44 - 48	20 - 25 - 30		
		C > 0.25 ... ≤ 0.55 % annealed	190	639	P2	40 - 44 - 48	20 - 25 - 30		
		C > 0.25 ... ≤ 0.55 % hardened and tempered	210	708	P3	40 - 44 - 48	20 - 25 - 30		
		C > 0.55 % annealed	190	639	P4	40 - 44 - 48	20 - 25 - 30		
		C > 0.55 % hardened and tempered	300	1013	P5	35 - 40 - 45	15 - 23 - 30		
		Machining steel (short-chipping) tempered	220	745	P6	38 - 42 - 46	25 - 30 - 35		
	Low alloyed steel	annealed	175	591	P7	22 - 26 - 30	10 - 15 - 20		
		hardened and tempered	300	1013	P8	18 - 22 - 26	8 - 12 - 16		
		hardened and tempered	380	1282	P9	18 - 22 - 26	8 - 12 - 16		
		hardened and tempered	430	1477	P10	18 - 22 - 26	8 - 12 - 16		
	High alloyed steel and high alloyed tool steel	annealed	200	675	P11	18 - 22 - 26	12 - 16 - 20		
		hardened	300	1013	P12	12 - 16 - 20	-		
		hardened	400	1361	P13	12 - 16 - 20	-		
	Stainless steel	ferritic / martensitic, annealed	200	675	P14	14 - 18 - 22	6 - 10 - 14		
		martensitic, hardened and tempered	330	1114	P15	8 - 12 - 16	4 - 8 - 12		
M	Stainless steel	austenitic, chilled	200	675	M1	14 - 18 - 22	6 - 10 - 14		
		austenitic, precipitation-hardened (PH)	300	1013	M2	8 - 12 - 16	4 - 8 - 12		
		austenitic-ferritic, Duplex	230	778	M3	10 - 15 - 20	2 - 6 - 10		
K	Malleable cast iron	ferritic	200	675	K1	29 - 33 - 37	21 - 25 - 29		
		pearlitic	260	867	K2	24 - 28 - 32	16 - 20 - 24		
	Cast iron	low tensile strength	180	602	K3	34 - 38 - 42	26 - 30 - 34		
		high tensile strength / austenitic	245	825	K4	31 - 35 - 39	26 - 30 - 34		
	Cast iron with nodular graphite	ferritic	155	518	K5	29 - 33 - 37	20 - 25 - 30		
		pearlitic	265	885	K6	24 - 28 - 32	15 - 20 - 25		
GGV (CGI)		200	675	K7	-	-			
N	Aluminium alloys long chipping	not heat treatable	30	-	N1	-	-		
		heat treatable, heat treated	100	343	N2	-	-		
	Casted aluminium alloys	≤ 12 % Si, not heat treatable	75	260	N3	-	-		
		≤ 12 % Si, aushärtbar, ausgehärtet	90	314	N4	-	-		
		> 12 % Si, not heat treatable	130	447	N5	-	-		
	Magnesium alloys		70	250	N6	70 - 80 - 90	60 - 70 - 80		
	Copper and copper alloys (Brass / Bronze)	Unalloyed, elektrolyte copper	100	343	N7	65 - 70 - 75	55 - 60 - 65		
		Brass, Bronze	90	314	N8	70 - 75 - 80	55 - 60 - 65		
		Cu-alloys, short-chipping	110	382	N9	40 - 45 - 50	25 - 30 - 35		
		High-tensile, Ampco	300	1013	N10	15 - 20 - 25	8 - 12 - 16		
Non-ferrous materials	Lead alloys (without abrasive filling material)	-	-	N11	20 - 25 - 30	14 - 18 - 22			
	Duroplastic (without abrasive filling material)	-	-	N12	35 - 40 - 45	24 - 28 - 32			
	Plastic glas fibre reinforced GFRP	-	-	N13	-	-			
	Plastic carbon fibre reinforced CFRP	-	-	N14	-	-			
	Plastic aramid fibre reinforced AFRP	-	-	N15	-	-			
	Graphite (tech.)	80 Shore	-	N16	-	-			
S	High temperature resistant alloys	Fe-Basis	annealed	200	675	S1	4 - 7 - 10	-	
			heat treated	280	943	S2	4 - 7 - 10	-	
		Ni- or Co-alloyed	annealed	250	839	S3	4 - 7 - 10	-	
			heat treated	350	1177	S4	4 - 7 - 10	-	
			casting	320	1076	S5	4 - 7 - 10	-	
	Titanium alloys	Pure titan	200	675	S6	7 - 10 - 13	-		
		α- and β-alloys, heat treated	375	1262	S7	5 - 8 - 11	-		
		β-alloys	410	1396	S8	5 - 8 - 11	-		
	Wolfram alloys		300	1013	S9	-	-		
	Molybdän alloys		300	1013	S10	-	-		
H	Hardened steel	hardened	50 HRC	-	H1	-	-		
		hardened	55 HRC	-	H2	-	-		
		hardened	60 HRC	-	H3	-	-		
	Hardened cast iron	hardened	55 HRC	-	H4	-	-		

The recommended cutting data are only approximate values. It may be necessary to adjust them to each individual machining application.



# Tableaux des avances valeurs de coupe recommandées – Foret à pointer NC

ISO	Matériaux		Dureté Brinell	Résistance (N/mm <sup>2</sup> )	Groupe d'usinage	Vitesse de coupe Vc (m/min)	
						VHM TAIN	PM-HSS TAIN
P	Acier non allié	C ≤ 0,25 % recuit	125	428	P1	40 - 44 - 48	20 - 25 - 30
		C > 0,25 ... ≤ 0,55 % recuit	190	639	P2	40 - 44 - 48	20 - 25 - 30
		C > 0,25 ... ≤ 0,55 % traité	210	708	P3	40 - 44 - 48	20 - 25 - 30
		C > 0,55 % recuit	190	639	P4	40 - 44 - 48	20 - 25 - 30
		C > 0,55 % traité	300	1013	P5	35 - 40 - 45	15 - 23 - 30
		Aciers de décolletage (à copeaux courts) recuit	220	745	P6	38 - 42 - 46	25 - 30 - 35
	Acier faiblement allié	recuit	175	591	P7	22 - 26 - 30	10 - 15 - 20
		traité	300	1013	P8	18 - 22 - 26	8 - 12 - 16
		traité	380	1282	P9	18 - 22 - 26	8 - 12 - 16
		traité	430	1477	P10	18 - 22 - 26	8 - 12 - 16
	Acier allié et acier outil allié	recuit	200	675	P11	18 - 22 - 26	12 - 16 - 20
		trempe et revenu	300	1013	P12	12 - 16 - 20	-
		trempe et revenu	400	1361	P13	12 - 16 - 20	-
	Acier inox	ferritique, martensitique, recuit	200	675	P14	14 - 18 - 22	6 - 10 - 14
		martensitique, traité	330	1114	P15	8 - 12 - 16	4 - 8 - 12
M	Acier inox	austénitique	200	675	M1	14 - 18 - 22	6 - 10 - 14
		austénitique	300	1013	M2	8 - 12 - 16	4 - 8 - 12
		austénitique-ferritique, Duplex	230	778	M3	10 - 15 - 20	2 - 6 - 10
K	Fonte malléable	ferritique	200	675	K1	29 - 33 - 37	21 - 25 - 29
		perlitique	260	867	K2	24 - 28 - 32	16 - 20 - 24
	Fonte grise	faible résistance	180	602	K3	34 - 38 - 42	26 - 30 - 34
		haute résistance / austénitique	245	825	K4	31 - 35 - 39	26 - 30 - 34
	Fonte à Graphite sphéroïdale	ferritique	155	518	K5	29 - 33 - 37	20 - 25 - 30
		perlitique	265	885	K6	24 - 28 - 32	15 - 20 - 25
GGV (CGI)		200	675	K7	-	-	
N	Alliages de fonderie d'aluminium	ne pouvant pas subir un durcissement	30	-	N1	-	-
		pouvant subir un durcissement, durci	100	343	N2	-	-
	Alliage de fonte d'aluminium	≤ 12 % Si, ne pouvant pas subir de durcissement	75	260	N3	-	-
		≤ 12 % Si, pouvant subir un durcissement, durci	90	314	N4	-	-
		> 12 % Si, ne pouvant pas subir de durcissement	130	447	N5	-	-
Alliage de Magnésium		70	250	N6	70 - 80 - 90	60 - 70 - 80	
Cuivre et alliage de cuivre (bronze / laiton)	non allié, cuivre électrolytique	100	343	N7	65 - 70 - 75	55 - 60 - 65	
	Laiton, bronze, fonte rouge	90	314	N8	70 - 75 - 80	55 - 60 - 65	
	Alliage de cuivre à copeaux courts	110	382	N9	40 - 45 - 50	25 - 30 - 35	
	forte résistance, Ampco	300	1013	N10	15 - 20 - 25	8 - 12 - 16	
Matériaux non métalliques	Thermoplaste (sans agents de charge abrasives)	-	-	N11	20 - 25 - 30	14 - 18 - 22	
	Duroplaste (sans agents de charge abrasives)	-	-	N12	35 - 40 - 45	24 - 28 - 32	
	Matière plastique renforcée de fibres de verre GFRP	-	-	N13	-	-	
	Matière plastique renforcé composite CFRP	-	-	N14	-	-	
	Plastique renforcé fibre aramide AFRP	-	-	N15	-	-	
	Graphite		80 Shore	-	N16	-	-
S	Alliages réfractaires	à base de Fe recuit	200	675	S1	4 - 7 - 10	-
		à base de Fe durci	280	943	S2	4 - 7 - 10	-
		à base de Fe recuit	250	839	S3	4 - 7 - 10	-
		à base Ni ou Co durci	350	1177	S4	4 - 7 - 10	-
		à base Ni ou Co jeter	320	1076	S5	4 - 7 - 10	-
	Alliage de titane	Titane pur	200	675	S6	7 - 10 - 13	-
		Alliages Alpha + Beta, trempé	375	1262	S7	5 - 8 - 11	-
		Alliages Beta	410	1396	S8	5 - 8 - 11	-
	Alliage de tungstène		300	1013	S9	-	-
	Alliage de molybdène		300	1013	S10	-	-
H	Acier trempé	trempe et revenu	50 HRC	-	H1	-	-
		trempe et revenu	55 HRC	-	H2	-	-
		trempe et revenu	60 HRC	-	H3	-	-
	Fonte durci	trempe et revenu	55 HRC	-	H4	-	-

Les valeurs du tableau sont indicatives. Il peut être nécessaire de les adapter aux conditions d'usinage respectives.



# Empfohlene Schnittwerte VHM-Schaftfräser – Zentrierbohrer

Werkstoff- gruppe	Gliederung der Werkstoffhauptgruppen und Kennbuchstaben			Brinell-Härte	Zugfestigkeit Rm (N/mm <sup>2</sup> )	Zerspanungsgruppe	Schnittgeschwindigkeit V <sub>c</sub> (m/min)		
							VHM TAIN	PM-HSS TAIN	
<b>P</b>	Unlegierter Stahl	C ≤ 0,25 %	geglüht	125	428	P1	25 - 30 - 35	20 - 25 - 30	
		C > 0,25 ... ≤ 0,55 %	geglüht	190	639	P2	25 - 30 - 35	20 - 25 - 30	
		C > 0,25 ... ≤ 0,55 %	vergütet	210	708	P3	25 - 30 - 35	20 - 25 - 30	
		C > 0,55 %	geglüht	190	639	P4	25 - 30 - 35	20 - 25 - 30	
		C > 0,55 %	vergütet	300	1013	P5	20 - 25 - 30	15 - 20 - 25	
		Automatenstahl (kurzspanend)	geglüht	220	745	P6	30 - 35 - 40	25 - 30 - 35	
	Niedrig legierter Stahl		geglüht	175	591	P7	14 - 18 - 22	10 - 15 - 20	
			vergütet	300	1013	P8	14 - 18 - 22	10 - 15 - 20	
			vergütet	380	1282	P9	8 - 10 - 12	4 - 8 - 12	
			vergütet	430	1477	P10	8 - 10 - 12	4 - 8 - 12	
	Hochlegierter Stahl und hochlegierter Werkzeugstahl		geglüht	200	675	P11	8 - 10 - 12	8 - 10 - 12	
			gehärtet und angelassen	300	1013	P12	8 - 10 - 12	8 - 10 - 12	
			gehärtet und angelassen	400	1361	P13	4 - 8 - 12	4 - 6 - 8	
	Nichtrostender Stahl		ferritisch / martensitisch, geglüht	200	675	P14	12 - 15 - 18	8 - 10 - 12	
			martensitisch, vergütet	330	1114	P15	4 - 8 - 12	4 - 6 - 8	
<b>M</b>	Nichtrostender Stahl		austenitisch, abgeschreckt	200	675	M1	12 - 15 - 18	8 - 10 - 12	
			austenitisch, ausscheidungsgehärtet (PH)	300	1013	M2	8 - 10 - 12	4 - 8 - 12	
			austenitisch-ferritisch, Duplex	230	778	M3	12 - 15 - 18	8 - 10 - 12	
<b>K</b>	Temperguss		ferritisch	200	675	K1	25 - 30 - 35	20 - 25 - 30	
			perritisch	260	867	K2	20 - 25 - 30	15 - 20 - 25	
	Grauguss		niedrige Festigkeit	180	602	K3	25 - 30 - 35	20 - 25 - 30	
			hohe Festigkeit / austenitisch	245	825	K4	25 - 30 - 35	20 - 25 - 30	
	Gusseisen mit Kugelgraphit		ferritisch	155	518	K5	25 - 30 - 35	20 - 25 - 30	
			perritisch	265	885	K6	20 - 25 - 30	15 - 20 - 25	
GGV (CGI)			200	675	K7	-	-		
<b>N</b>	Aluminium-Knetlegierungen		nicht aushärtbar	30	-	N1	-	-	
			aushärtbar, ausgehärtet	100	343	N2	-	-	
	Aluminium-Gusslegierungen		≤ 12 % Si, nicht aushärtbar	75	260	N3	-	-	
			≤ 12 % Si, aushärtbar, ausgehärtet	90	314	N4	-	-	
			> 12 % Si, nicht aushärtbar	130	447	N5	-	-	
	Magnesiumlegierungen			70	250	N6	65 - 70 - 75	55 - 60 - 65	
	Kupfer und Kupferlegierungen (Bronze / Messing)		unlegiert, Elektrolytkupfer	100	343	N7	55 - 60 - 65	45 - 50 - 55	
			Messing, Bronze, Rotguss	90	314	N8	65 - 70 - 75	55 - 60 - 65	
			Cu-Legierung, kurzspanend	110	382	N9	30 - 35 - 40	25 - 30 - 35	
			hochfest, Ampco	300	1013	N10	18 - 20 - 22	12 - 15 - 18	
Nichtmetallische Werkstoffe		Thermoplaste (ohne abrasive Füllstoffe)	-	-	N11	25 - 30 - 35	20 - 25 - 30		
		Duroplaste (ohne abrasive Füllstoffe)	-	-	N12	15 - 20 - 25	12 - 15 - 18		
		Kunststoff glasfaserverstärkt GFRP	-	-	N13	-	-		
		Kunststoff kohlefaserverstärkt CFRP	-	-	N14	-	-		
		Kunststoff aramidfaserverstärkt AFRP	-	-	N15	-	-		
		Graphit (technisch)		80 Shore	-	N16	-	-	
<b>S</b>	Warmfeste Legierungen	Fe-Basis	geglüht	200	675	S1	4 - 6 - 8	2 - 3 - 4	
			ausgehärtet	280	943	S2	4 - 6 - 8	2 - 3 - 4	
		Ni- oder Co-Basis	geglüht	250	839	S3	4 - 6 - 8	2 - 3 - 4	
			ausgehärtet	350	1177	S4	4 - 6 - 8	2 - 3 - 4	
			gegossen	320	1076	S5	4 - 6 - 8	2 - 3 - 4	
	Titanlegierungen		Reintitan	200	675	S6	4 - 6 - 8	3 - 5 - 7	
			α- und β-Legierungen, ausgehärtet	375	1262	S7	3 - 5 - 7	2 - 4 - 6	
			β-Legierungen	410	1396	S8	3 - 5 - 7	2 - 4 - 6	
	Wolframlegierungen			300	1013	S9	-	-	
	Molybdänlegierungen			300	1013	S10	-	-	
<b>H</b>	Gehärteter Stahl		gehärtet und angelassen	50 HRC	-	H1	-	-	
			gehärtet und angelassen	55 HRC	-	H2	-	-	
			gehärtet und angelassen	60 HRC	-	H3	-	-	
	Gehärtetes Gusseisen		gehärtet und angelassen	55 HRC	-	H4	-	-	

Die Tabellenwerte sind Richtwerte. Es kann notwendig sein, die Werte den jeweiligen Bearbeitungsumständen anzupassen.



Vorschub pro Umdrehung fn (mm/U)			
	∅ 1 - 3 mm	∅ 3 - 5 mm	∅ 5 - 8 mm
	0,01 - 0,03 - 0,05	0,06 - 0,07 - 0,08	0,10 - 0,11 - 0,12
	0,01 - 0,03 - 0,05	0,06 - 0,07 - 0,08	0,10 - 0,11 - 0,12
	0,01 - 0,03 - 0,05	0,06 - 0,07 - 0,08	0,10 - 0,11 - 0,12
	0,01 - 0,03 - 0,05	0,06 - 0,07 - 0,08	0,10 - 0,11 - 0,12
	0,01 - 0,03 - 0,05	0,06 - 0,07 - 0,08	0,10 - 0,11 - 0,12
	0,01 - 0,03 - 0,05	0,06 - 0,07 - 0,08	0,10 - 0,11 - 0,12
	0,01 - 0,03 - 0,05	0,06 - 0,07 - 0,08	0,10 - 0,11 - 0,12
	0,01 - 0,03 - 0,05	0,06 - 0,07 - 0,08	0,10 - 0,11 - 0,12
	0,01 - 0,03 - 0,04	0,05 - 0,06 - 0,06	0,08 - 0,09 - 0,10
	0,01 - 0,03 - 0,04	0,05 - 0,06 - 0,06	0,08 - 0,09 - 0,10
	0,01 - 0,03 - 0,04	0,05 - 0,06 - 0,06	0,08 - 0,09 - 0,10
	0,01 - 0,03 - 0,04	0,05 - 0,06 - 0,06	0,08 - 0,09 - 0,10
	0,01 - 0,03 - 0,04	0,05 - 0,06 - 0,06	0,08 - 0,09 - 0,10
	0,01 - 0,03 - 0,04	0,05 - 0,06 - 0,06	0,08 - 0,09 - 0,10
	0,01 - 0,03 - 0,04	0,05 - 0,06 - 0,06	0,08 - 0,09 - 0,10
	0,01 - 0,03 - 0,04	0,05 - 0,06 - 0,06	0,08 - 0,09 - 0,10
	0,01 - 0,03 - 0,04	0,05 - 0,06 - 0,06	0,08 - 0,09 - 0,10
	0,01 - 0,05 - 0,08	0,10 - 0,11 - 0,12	0,16 - 0,18 - 0,20
	0,01 - 0,04 - 0,06	0,08 - 0,09 - 0,10	0,12 - 0,14 - 0,16
	0,01 - 0,05 - 0,08	0,10 - 0,11 - 0,12	0,16 - 0,18 - 0,20
	0,01 - 0,05 - 0,08	0,10 - 0,11 - 0,12	0,16 - 0,18 - 0,20
	0,01 - 0,05 - 0,08	0,10 - 0,11 - 0,12	0,16 - 0,18 - 0,20
	0,01 - 0,04 - 0,06	0,08 - 0,09 - 0,10	0,12 - 0,14 - 0,16
	-	-	-
	-	-	-
	-	-	-
	-	-	-
	-	-	-
	0,01 - 0,05 - 0,08	0,10 - 0,11 - 0,12	0,16 - 0,18 - 0,20
	0,01 - 0,04 - 0,06	0,08 - 0,09 - 0,10	0,12 - 0,14 - 0,16
	0,01 - 0,04 - 0,06	0,08 - 0,09 - 0,10	0,12 - 0,14 - 0,16
	0,01 - 0,04 - 0,06	0,06 - 0,07 - 0,08	0,10 - 0,11 - 0,12
	0,01 - 0,03 - 0,05	0,06 - 0,07 - 0,08	0,10 - 0,11 - 0,12
	0,01 - 0,03 - 0,05	0,08 - 0,09 - 0,10	0,12 - 0,14 - 0,16
	0,01 - 0,03 - 0,05	0,06 - 0,07 - 0,08	0,10 - 0,11 - 0,12
	-	-	-
	-	-	-
	-	-	-
	-	-	-
	0,01 - 0,02 - 0,03	0,03 - 0,04 - 0,05	0,05 - 0,06 - 0,07
	0,01 - 0,02 - 0,03	0,03 - 0,04 - 0,05	0,05 - 0,06 - 0,07
	0,01 - 0,02 - 0,03	0,03 - 0,04 - 0,05	0,05 - 0,06 - 0,07
	0,01 - 0,02 - 0,03	0,03 - 0,04 - 0,05	0,05 - 0,06 - 0,07
	0,01 - 0,02 - 0,03	0,03 - 0,04 - 0,05	0,05 - 0,06 - 0,07
	0,01 - 0,02 - 0,03	0,04 - 0,05 - 0,05	0,06 - 0,07 - 0,08
	0,01 - 0,02 - 0,03	0,04 - 0,05 - 0,05	0,06 - 0,07 - 0,08
	0,01 - 0,02 - 0,03	0,04 - 0,05 - 0,05	0,06 - 0,07 - 0,08
	-	-	-
	-	-	-
	-	-	-
	-	-	-
	-	-	-

# Recommended cutting data Solid carbide end-mill – Centre drills

Material group	Structure of the material groups and identification letters		Brinell hardness HB	Tensile strength Rm (N/mm <sup>2</sup> )	Chipping group	Cutting speed V <sub>c</sub> (m/min)		
						VHM TAIN	PM-HSS TAIN	
P	Unalloyed steel	C ≤ 0.25 % annealed	125	428	P1	25 - 30 - 35	20 - 25 - 30	
		C > 0.25 ... ≤ 0.55 % annealed	190	639	P2	25 - 30 - 35	20 - 25 - 30	
		C > 0.25 ... ≤ 0.55 % hardened and tempered	210	708	P3	25 - 30 - 35	20 - 25 - 30	
		C > 0.55 % annealed	190	639	P4	25 - 30 - 35	20 - 25 - 30	
		C > 0.55 % hardened and tempered	300	1013	P5	20 - 25 - 30	15 - 20 - 25	
		Machining steel (short-chipping) tempered	220	745	P6	30 - 35 - 40	25 - 30 - 35	
	Low alloyed steel	annealed	175	591	P7	14 - 18 - 22	10 - 15 - 20	
		hardened and tempered	300	1013	P8	14 - 18 - 22	10 - 15 - 20	
		hardened and tempered	380	1282	P9	8 - 10 - 12	4 - 8 - 12	
		hardened and tempered	430	1477	P10	8 - 10 - 12	4 - 8 - 12	
	High alloyed steel and high alloyed tool steel	annealed	200	675	P11	8 - 10 - 12	8 - 10 - 12	
		hardened	300	1013	P12	8 - 10 - 12	8 - 10 - 12	
		hardened	400	1361	P13	4 - 8 - 12	4 - 6 - 8	
	Stainless steel	ferritic / martensitic, annealed	200	675	P14	12 - 15 - 18	8 - 10 - 12	
		martensitic, hardened and tempered	330	1114	P15	4 - 8 - 12	4 - 6 - 8	
M	Stainless steel	austenitic, chilled	200	675	M1	12 - 15 - 18	8 - 10 - 12	
		austenitic, precipitation-hardened (PH)	300	1013	M2	8 - 10 - 12	4 - 8 - 12	
		austenitic-ferritic, Duplex	230	778	M3	12 - 15 - 18	8 - 10 - 12	
K	Malleable cast iron	ferritic	200	675	K1	25 - 30 - 35	20 - 25 - 30	
		pearlitic	260	867	K2	20 - 25 - 30	15 - 20 - 25	
	Cast iron	low tensile strength	180	602	K3	25 - 30 - 35	20 - 25 - 30	
		high tensile strength / austenitic	245	825	K4	25 - 30 - 35	20 - 25 - 30	
	Cast iron with nodular graphite	ferritic	155	518	K5	25 - 30 - 35	20 - 25 - 30	
		pearlitic	265	885	K6	20 - 25 - 30	15 - 20 - 25	
GGV (CGI)		200	675	K7	-	-		
N	Aluminium alloys long chipping	not heat treatable	30	-	N1	-	-	
		heat treatable, heat treated	100	343	N2	-	-	
	Casted aluminium alloys	≤ 12 % Si, not heat treatable	75	260	N3	-	-	
		≤ 12 % Si, aushärtbar, ausgehärtet	90	314	N4	-	-	
		> 12 % Si, not heat treatable	130	447	N5	-	-	
	Magnesium alloys		70	250	N6	65 - 70 - 75	55 - 60 - 65	
	Copper and copper alloys (Brass / Bronze)	Unalloyed, elektrolyte copper	100	343	N7	55 - 60 - 65	45 - 50 - 55	
		Brass, Bronze	90	314	N8	65 - 70 - 75	55 - 60 - 65	
		Cu-alloys, short-chipping	110	382	N9	30 - 35 - 40	25 - 30 - 35	
		High-tensile, Ampco	300	1013	N10	18 - 20 - 22	12 - 15 - 18	
	Non-ferrous materials	Lead alloys (without abrasive filling material)	-	-	N11	25 - 30 - 35	20 - 25 - 30	
Duroplastic (without abrasive filling material)		-	-	N12	15 - 20 - 25	12 - 15 - 18		
Plastic glas fibre reinforced GFRP		-	-	N13	-	-		
Plastic carbon fibre reinforced CFRP		-	-	N14	-	-		
Plastic aramid fibre reinforced AFRP		-	-	N15	-	-		
Graphite (tech.)			80 Shore	-	N16	-	-	
S	High temperature resistant alloys	Fe-Basis	annealed	200	675	S1	4 - 6 - 8	2 - 3 - 4
			heat treated	280	943	S2	4 - 6 - 8	2 - 3 - 4
		Ni- or Co-alloyed	annealed	250	839	S3	4 - 6 - 8	2 - 3 - 4
			heat treated	350	1177	S4	4 - 6 - 8	2 - 3 - 4
			casting	320	1076	S5	4 - 6 - 8	2 - 3 - 4
	Titanium alloys	Pure titan	200	675	S6	4 - 6 - 8	3 - 5 - 7	
		α- and β-alloys, heat treated	375	1262	S7	3 - 5 - 7	2 - 4 - 6	
		β-alloys	410	1396	S8	3 - 5 - 7	2 - 4 - 6	
	Wolfram alloys		300	1013	S9	-	-	
	Molybdän alloys		300	1013	S10	-	-	
H	Hardened steel	hardened	50 HRC	-	H1	-	-	
		hardened	55 HRC	-	H2	-	-	
		hardened	60 HRC	-	H3	-	-	
	Hardened cast iron	hardened	55 HRC	-	H4	-	-	

The recommended cutting data are only approximate values. It may be necessary to adjust them to each individual machining application.

SP

Feed per revolution fn (mm/U)			
	Ø 1 - 3 mm	Ø 3 - 5 mm	Ø 5 - 8 mm
	0,01 - 0,03 - 0,05	0,06 - 0,07 - 0,08	0,10 - 0,11 - 0,12
	0,01 - 0,03 - 0,05	0,06 - 0,07 - 0,08	0,10 - 0,11 - 0,12
	0,01 - 0,03 - 0,05	0,06 - 0,07 - 0,08	0,10 - 0,11 - 0,12
	0,01 - 0,03 - 0,05	0,06 - 0,07 - 0,08	0,10 - 0,11 - 0,12
	0,01 - 0,03 - 0,05	0,06 - 0,07 - 0,08	0,10 - 0,11 - 0,12
	0,01 - 0,03 - 0,05	0,06 - 0,07 - 0,08	0,10 - 0,11 - 0,12
	0,01 - 0,03 - 0,05	0,06 - 0,07 - 0,08	0,10 - 0,11 - 0,12
	0,01 - 0,03 - 0,05	0,06 - 0,07 - 0,08	0,10 - 0,11 - 0,12
	0,01 - 0,03 - 0,04	0,05 - 0,06 - 0,06	0,08 - 0,09 - 0,10
	0,01 - 0,03 - 0,04	0,05 - 0,06 - 0,06	0,08 - 0,09 - 0,10
	0,01 - 0,03 - 0,04	0,05 - 0,06 - 0,06	0,08 - 0,09 - 0,10
	0,01 - 0,03 - 0,04	0,05 - 0,06 - 0,06	0,08 - 0,09 - 0,10
	0,01 - 0,03 - 0,04	0,05 - 0,06 - 0,06	0,08 - 0,09 - 0,10
	0,01 - 0,03 - 0,04	0,05 - 0,06 - 0,06	0,08 - 0,09 - 0,10
	0,01 - 0,03 - 0,04	0,05 - 0,06 - 0,06	0,08 - 0,09 - 0,10
	0,01 - 0,03 - 0,04	0,05 - 0,06 - 0,06	0,08 - 0,09 - 0,10
	0,01 - 0,03 - 0,04	0,05 - 0,06 - 0,06	0,08 - 0,09 - 0,10
	0,01 - 0,05 - 0,08	0,10 - 0,11 - 0,12	0,16 - 0,18 - 0,20
	0,01 - 0,04 - 0,06	0,08 - 0,09 - 0,10	0,12 - 0,14 - 0,16
	0,01 - 0,05 - 0,08	0,10 - 0,11 - 0,12	0,16 - 0,18 - 0,20
	0,01 - 0,05 - 0,08	0,10 - 0,11 - 0,12	0,16 - 0,18 - 0,20
	0,01 - 0,05 - 0,08	0,10 - 0,11 - 0,12	0,16 - 0,18 - 0,20
	0,01 - 0,04 - 0,06	0,08 - 0,09 - 0,10	0,12 - 0,14 - 0,16
	-	-	-
	-	-	-
	-	-	-
	-	-	-
	-	-	-
	0,01 - 0,05 - 0,08	0,10 - 0,11 - 0,12	0,16 - 0,18 - 0,20
	0,01 - 0,04 - 0,06	0,08 - 0,09 - 0,10	0,12 - 0,14 - 0,16
	0,01 - 0,04 - 0,06	0,08 - 0,09 - 0,10	0,12 - 0,14 - 0,16
	0,01 - 0,04 - 0,06	0,06 - 0,07 - 0,08	0,10 - 0,11 - 0,12
	0,01 - 0,03 - 0,05	0,06 - 0,07 - 0,08	0,10 - 0,11 - 0,12
	0,01 - 0,03 - 0,05	0,08 - 0,09 - 0,10	0,12 - 0,14 - 0,16
	0,01 - 0,03 - 0,05	0,06 - 0,07 - 0,08	0,10 - 0,11 - 0,12
	-	-	-
	-	-	-
	-	-	-
	-	-	-
	0,01 - 0,02 - 0,03	0,03 - 0,04 - 0,05	0,05 - 0,06 - 0,07
	0,01 - 0,02 - 0,03	0,03 - 0,04 - 0,05	0,05 - 0,06 - 0,07
	0,01 - 0,02 - 0,03	0,03 - 0,04 - 0,05	0,05 - 0,06 - 0,07
	0,01 - 0,02 - 0,03	0,03 - 0,04 - 0,05	0,05 - 0,06 - 0,07
	0,01 - 0,02 - 0,03	0,03 - 0,04 - 0,05	0,05 - 0,06 - 0,07
	0,01 - 0,02 - 0,03	0,04 - 0,05 - 0,05	0,06 - 0,07 - 0,08
	0,01 - 0,02 - 0,03	0,04 - 0,05 - 0,05	0,06 - 0,07 - 0,08
	0,01 - 0,02 - 0,03	0,04 - 0,05 - 0,05	0,06 - 0,07 - 0,08
	-	-	-
	-	-	-
	-	-	-
	-	-	-
	-	-	-

# Tableaux des avances valeurs de coupe recommandées – Foret de centrage

ISO	Matériaux		Dureté Brinell	Résistance (N/mm <sup>2</sup> )	Groupe d'usinage	Vitesse de coupe Vc (m/min)	
						VHM TAIN	PM-HSS TAIN
P	Acier non allié	C ≤ 0,25 % recuit	125	428	P1	25 - 30 - 35	20 - 25 - 30
		C > 0,25 ... ≤ 0,55 % recuit	190	639	P2	25 - 30 - 35	20 - 25 - 30
		C > 0,25 ... ≤ 0,55 % traité	210	708	P3	25 - 30 - 35	20 - 25 - 30
		C > 0,55 % recuit	190	639	P4	25 - 30 - 35	20 - 25 - 30
		C > 0,55 % traité	300	1013	P5	20 - 25 - 30	15 - 20 - 25
		Aciers de décolletage (à copeaux courts) recuit	220	745	P6	30 - 35 - 40	25 - 30 - 35
	Acier faiblement allié	recuit	175	591	P7	14 - 18 - 22	10 - 15 - 20
		traité	300	1013	P8	14 - 18 - 22	10 - 15 - 20
		traité	380	1282	P9	8 - 10 - 12	4 - 8 - 12
		traité	430	1477	P10	8 - 10 - 12	4 - 8 - 12
	Acier allié et acier outil allié	recuit	200	675	P11	8 - 10 - 12	8 - 10 - 12
		trempe et revenu	300	1013	P12	8 - 10 - 12	8 - 10 - 12
		trempe et revenu	400	1361	P13	4 - 8 - 12	4 - 6 - 8
	Acier inox	ferritique, martensitique, recuit	200	675	P14	12 - 15 - 18	8 - 10 - 12
		martensitique, traité	330	1114	P15	4 - 8 - 12	4 - 6 - 8
M	Acier inox	austénitique	200	675	M1	12 - 15 - 18	8 - 10 - 12
		austénitique	300	1013	M2	8 - 10 - 12	4 - 8 - 12
		austénitique-ferritique, Duplex	230	778	M3	12 - 15 - 18	8 - 10 - 12
K	Fonte malléable	ferritique	200	675	K1	25 - 30 - 35	20 - 25 - 30
		perlitique	260	867	K2	20 - 25 - 30	15 - 20 - 25
	Fonte grise	faible résistance	180	602	K3	25 - 30 - 35	20 - 25 - 30
		haute résistance / austénitique	245	825	K4	25 - 30 - 35	20 - 25 - 30
	Fonte à Graphite sphéroïdale	ferritique	155	518	K5	25 - 30 - 35	20 - 25 - 30
		perlitique	265	885	K6	20 - 25 - 30	15 - 20 - 25
GGV (CGI)		200	675	K7	-	-	
N	Alliages de fonderie d'aluminium	ne pouvant pas subir un durcissement	30	-	N1	-	-
		pouvant subir un durcissement, durci	100	343	N2	-	-
	Alliage de fonte d'aluminium	≤ 12 % Si, ne pouvant pas subir de durcissement	75	260	N3	-	-
		≤ 12 % Si, pouvant subir un durcissement, durci	90	314	N4	-	-
		> 12 % Si, ne pouvant pas subir de durcissement	130	447	N5	-	-
Alliage de Magnésium		70	250	N6	65 - 70 - 75	55 - 60 - 65	
N	Cuivre et alliage de cuivre (bronze / laiton)	non allié, cuivre électrolytique	100	343	N7	55 - 60 - 65	45 - 50 - 55
		Laiton, bronze, fonte rouge	90	314	N8	65 - 70 - 75	55 - 60 - 65
		Alliage de cuivre à copeaux courts	110	382	N9	30 - 35 - 40	25 - 30 - 35
		forte résistance, Ampco	300	1013	N10	18 - 20 - 22	12 - 15 - 18
	Matériaux non métalliques	Thermoplaste (sans agents de charge abrasives)	-	-	N11	25 - 30 - 35	20 - 25 - 30
Duroplaste (sans agents de charge abrasives)		-	-	N12	15 - 20 - 25	12 - 15 - 18	
Matière plastique renforcée de fibres de verre GFRP		-	-	N13	-	-	
Matière plastique renforcé composite CFRP		-	-	N14	-	-	
Plastique renforcé fibre aramide AFRP		-	-	N15	-	-	
Graphite		80 Shore	-	N16	-	-	
S	Alliages réfractaires	à base de Fe recuit	200	675	S1	4 - 6 - 8	2 - 3 - 4
		durci	280	943	S2	4 - 6 - 8	2 - 3 - 4
		recuit	250	839	S3	4 - 6 - 8	2 - 3 - 4
		à base Ni ou Co durci	350	1177	S4	4 - 6 - 8	2 - 3 - 4
		jeter	320	1076	S5	4 - 6 - 8	2 - 3 - 4
	Alliage de titane	Titane pur	200	675	S6	4 - 6 - 8	3 - 5 - 7
		Alliages Alpha + Beta, trempé	375	1262	S7	3 - 5 - 7	2 - 4 - 6
		Alliages Beta	410	1396	S8	3 - 5 - 7	2 - 4 - 6
	Alliage de tungstène		300	1013	S9	-	-
	Alliage de molybdène		300	1013	S10	-	-
H	Acier trempé	trempe et revenu	50 HRC	-	H1	-	-
		trempe et revenu	55 HRC	-	H2	-	-
		trempe et revenu	60 HRC	-	H3	-	-
	Fonte durci	trempe et revenu	55 HRC	-	H4	-	-

Les valeurs du tableau sont indicatives. Il peut être nécessaire de les adapter aux conditions d'usinage respectives.

Avance par tour fn (mm/U)			
	Ø 1 - 3 mm	Ø 3 - 5 mm	Ø 5 - 8 mm
	0,01 - 0,03 - 0,05	0,06 - 0,07 - 0,08	0,10 - 0,11 - 0,12
	0,01 - 0,03 - 0,05	0,06 - 0,07 - 0,08	0,10 - 0,11 - 0,12
	0,01 - 0,03 - 0,05	0,06 - 0,07 - 0,08	0,10 - 0,11 - 0,12
	0,01 - 0,03 - 0,05	0,06 - 0,07 - 0,08	0,10 - 0,11 - 0,12
	0,01 - 0,03 - 0,05	0,06 - 0,07 - 0,08	0,10 - 0,11 - 0,12
	0,01 - 0,03 - 0,05	0,06 - 0,07 - 0,08	0,10 - 0,11 - 0,12
	0,01 - 0,03 - 0,05	0,06 - 0,07 - 0,08	0,10 - 0,11 - 0,12
	0,01 - 0,03 - 0,05	0,06 - 0,07 - 0,08	0,10 - 0,11 - 0,12
	0,01 - 0,03 - 0,04	0,05 - 0,06 - 0,06	0,08 - 0,09 - 0,10
	0,01 - 0,03 - 0,04	0,05 - 0,06 - 0,06	0,08 - 0,09 - 0,10
	0,01 - 0,03 - 0,04	0,05 - 0,06 - 0,06	0,08 - 0,09 - 0,10
	0,01 - 0,03 - 0,04	0,05 - 0,06 - 0,06	0,08 - 0,09 - 0,10
	0,01 - 0,03 - 0,04	0,05 - 0,06 - 0,06	0,08 - 0,09 - 0,10
	0,01 - 0,03 - 0,04	0,05 - 0,06 - 0,06	0,08 - 0,09 - 0,10
	0,01 - 0,03 - 0,04	0,05 - 0,06 - 0,06	0,08 - 0,09 - 0,10
	0,01 - 0,03 - 0,04	0,05 - 0,06 - 0,06	0,08 - 0,09 - 0,10
	0,01 - 0,03 - 0,04	0,05 - 0,06 - 0,06	0,08 - 0,09 - 0,10
	0,01 - 0,05 - 0,08	0,10 - 0,11 - 0,12	0,16 - 0,18 - 0,20
	0,01 - 0,04 - 0,06	0,08 - 0,09 - 0,10	0,12 - 0,14 - 0,16
	0,01 - 0,05 - 0,08	0,10 - 0,11 - 0,12	0,16 - 0,18 - 0,20
	0,01 - 0,05 - 0,08	0,10 - 0,11 - 0,12	0,16 - 0,18 - 0,20
	0,01 - 0,05 - 0,08	0,10 - 0,11 - 0,12	0,16 - 0,18 - 0,20
	0,01 - 0,04 - 0,06	0,08 - 0,09 - 0,10	0,12 - 0,14 - 0,16
	-	-	-
	-	-	-
	-	-	-
	-	-	-
	-	-	-
	0,01 - 0,05 - 0,08	0,10 - 0,11 - 0,12	0,16 - 0,18 - 0,20
	0,01 - 0,04 - 0,06	0,08 - 0,09 - 0,10	0,12 - 0,14 - 0,16
	0,01 - 0,04 - 0,06	0,08 - 0,09 - 0,10	0,12 - 0,14 - 0,16
	0,01 - 0,04 - 0,06	0,06 - 0,07 - 0,08	0,10 - 0,11 - 0,12
	0,01 - 0,03 - 0,05	0,06 - 0,07 - 0,08	0,10 - 0,11 - 0,12
	0,01 - 0,03 - 0,05	0,08 - 0,09 - 0,10	0,12 - 0,14 - 0,16
	0,01 - 0,03 - 0,05	0,06 - 0,07 - 0,08	0,10 - 0,11 - 0,12
	-	-	-
	-	-	-
	-	-	-
	-	-	-
	0,01 - 0,02 - 0,03	0,03 - 0,04 - 0,05	0,05 - 0,06 - 0,07
	0,01 - 0,02 - 0,03	0,03 - 0,04 - 0,05	0,05 - 0,06 - 0,07
	0,01 - 0,02 - 0,03	0,03 - 0,04 - 0,05	0,05 - 0,06 - 0,07
	0,01 - 0,02 - 0,03	0,03 - 0,04 - 0,05	0,05 - 0,06 - 0,07
	0,01 - 0,02 - 0,03	0,03 - 0,04 - 0,05	0,05 - 0,06 - 0,07
	0,01 - 0,02 - 0,03	0,04 - 0,05 - 0,05	0,06 - 0,07 - 0,08
	0,01 - 0,02 - 0,03	0,04 - 0,05 - 0,05	0,06 - 0,07 - 0,08
	0,01 - 0,02 - 0,03	0,04 - 0,05 - 0,05	0,06 - 0,07 - 0,08
	-	-	-
	-	-	-
	-	-	-
	-	-	-
	-	-	-

# Vollhartmetall-Spiralbohrer – Empfohlener Kühlmitteldruck und Volumen

*Solid carbide drills – Recommended coolant pressure and volume*

Foret hélicoïdal en carbure monobloc – Pression du lubrifiant et volumes recommandés

## Empfohlenes Kühlmittel

*Recommended coolant*

## Liquide de refroidissement recommandé

Werkstoff <i>Material</i> Matériau	Empfohlenes Kühlmittel <i>Recommended coolant</i> Liquide de refroidissement recommandé
<b>Baustahl, Kohlenstoffstahl</b> <i>Structural steel, Carbon steel</i> Acier de construction, acier au carbone	<b>Emulsion (ca. 7 - 8%)</b> <i>Emulsion (approx. 7 - 8%)</i> Émulsion (env. 7 - 8 %)
<b>Legierter Stahl, Stahlguss</b> <i>Alloy steel, Cast steel</i> Acier allié, acier coulé	<b>Emulsion (ca. 7 - 8%) oder [Öl]</b> <i>Emulsion (approx. 7 - 8%) or [oil]</i> Émulsion (env. 7 - 8 %) ou [huile]
<b>Rostfreier Stahl, Federstahl</b> <i>Stainless steel, Spring steel</i> Acier inoxydable, acier à ressort	<b>Öl oder (Emulsion ca. 10 - 12%)</b> <i>Oil or (Emulsion approx. 10 - 12%)</i> Huile entière ou (émulsion env. 10 - 12 %)

## Mindestdruck [bar]

*Min. coolant pressure*

Pression minimales [bar]

Werkstoff / <i>Material</i> / Matériau	Durchmesser / <i>Diameter</i> / Diamètre [mm]			
	5 [bar]	10 [bar]	15 [bar]	20 [bar]
<b>Stahlbearbeitung</b> <i>Steel drilling</i> Usinage de l'acier	22	15	9	5
<b>Aluminiumbearbeitung</b> <i>Aluminium drilling</i> Usinage de l'aluminium	25	20	15	10
<b>Gussbearbeitung</b> <i>Cast drilling</i> Usinage de la fonte	38	30	20	18

## Mindestvolumen [L/min]

*Min. coolant volume*

Volumes minimaux [L/min]

Werkstoff / <i>Material</i> / Matériau	Durchmesser / <i>Diameter</i> / Diamètre [mm]			
	5 [L/min]	10 [L/min]	15 [L/min]	20 [L/min]
<b>Stahlbearbeitung</b> <i>Steel drilling</i> Usinage de l'acier	3	6	7	9
<b>Aluminiumbearbeitung</b> <i>Aluminium drilling</i> Usinage de l'aluminium	4	6	9	10
<b>Gussbearbeitung</b> <i>Cast drilling</i> Usinage de la fonte	5	9	14	16

## Anwendungshinweise 8xD / 10xD / 15xD / 20xD / 25xD / 30xD

Application notes 8xD / 10xD / 15xD / 20xD / 25xD / 30xD

Consignes d'utilisation 8xD / 10xD / 15xD / 20xD / 25xD / 30xD

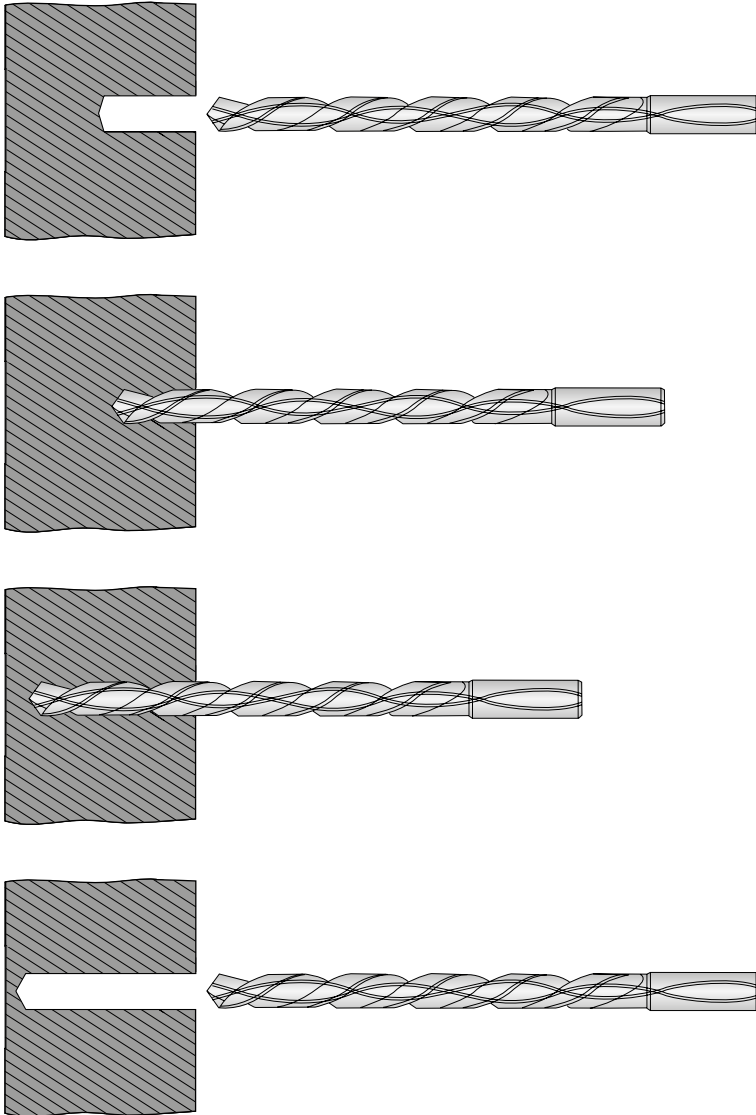

- 1. Pilotbohrung setzen zwischen 3 und 5xD tief im Nenndurchmesser (Tol. +0,1 mm). Verwenden Sie hierzu z. B. unsere VHM Bohrer in 3 oder 5xD (Toleranzklasse m7) welche sich hierfür hervorragend eignen.**  
*Pre-Drilling should be done at the diameter +0.1 mm using 3 x D or 5 x D.*  
Réglez le perçage pilote entre 3 et 5xD de profondeur dans le diamètre nominal (tol. +0,1 mm). À cet effet, utilisez par ex. nos forets en carbure monobloc en 3 ou 5xD (classe de tolérance m7) qui sont parfaitement appropriés pour cela.
- 2. Zur eigentlichen Bohrbearbeitung mit geringer Drehzahl in die Pilotbohrung einfahren (n = 300 U/min, Vf = 400 mm/min).**  
*For main drilling, proceed with low RPM for pre-drilled length. (RPM 300 U/min, Feed 400 mm/min).*  
A l'amorce du perçage long entrez à vitesse réduite dans le trou pilote (n = 300 tr/min, Vf = 400 mm/min).
- 3. Kurz vor dem Grund der Pilotbohrung (ca. 0,5 bis 1 mm), den Vorschub auf null reduzieren und die Drehzahl auf empfohlene Werte erhöhen (siehe Schnittwerttabelle). Ebenso sollte nun die Kühlung aktiviert werden.**  
*Just before the end of the pre-drilled hole, reduce feed to zero and increase the RPM according to the recommended cutting condition chart (see below).*  
Juste avant d'atteindre le fond du forage pilote (env. 0,5 jusqu'à 1 mm), réglez l'avance sur zéro et augmentez la vitesse aux valeurs recommandées (voir tableau des valeurs de coupe). Vous devez maintenant activer le refroidissement.
- 4. Nun mit der Bohrbearbeitung fortfahren, indem der Vorschub auf die empfohlenen Werte erhöht wird. Bohren möglichst in einem Zug ohne Spanbruchzyklus.**  
*Then continue to drill the hole by increasing the feed without step drilling.*  
Poursuivez le perçage en augmentant l'avance aux valeurs recommandées. Percez en une fois sans cycle de fragmentation des copeaux.
- 5. Nach Erreichen der Endbohrtiefe mit Drehzahl 300 U/min und Vorschubgeschwindigkeit 1000 mm/min aus der Bohrung herausfahren.**  
*When retracting drill from pre-drilled hole after drilling, RPM should be reduced to 300 U/Min and feed should be 1000 mm/min.*  
Après avoir atteint la profondeur de perçage finale, sortez du perçage à une vitesse de rotation de 300 tr/min et à une vitesse d'avance de 1 000 mm/min.
- 6. Bei Durchgangsbohrungen, während des Austrittes den Arbeitsvorschub um ca. 50% reduzieren (f ca. 0,05 - 0,1 mm/U).**  
*When retracting the drill from the pre-drilled hole, when clear the feed can then be reduced by 50%. (f = ca. 0.05 - 0.1 mm/U).*  
Pour les trous de passage, réduisez l'avance d'env. 50 % (pour env. 0,05 - 0,1 mm/tr) lorsque vous retirez le foret.

# Merkmale VHM- und PM-HSS-Spiralbohrer

Characteristics of solid carbide drills and powder metal drills

Caractéristiques des forets hélicoïdaux en carbure monobloc et PM-HSS

**ARNO®-Vollhartmetallfräser sind aus Feinstkorn-Hartmetall (Ultra-Micro-Grain) gefertigt.**

**Die Korngrößen betragen 0–0,5 µm und je nach Ausführung sind sie mit verschiedenen Beschichtungen versehen (TiAlN, TiCN bzw. Diamant).**

*The ARNO® Solid carbide milling range is made of ultra micrograin carbide.*

*The grain size is between 0–0.5 micron and coated depending on application with various coatings (TiAlN, TiCN or TIA70).*

Les forets en carbure monobloc ARNO® sont fabriquées en carbure micrograins (Ultra-Micro-Grain).

Les tailles des grains sont comprises entre 0 et 0,5 µm et les fraises sont dotées d'un revêtement, différent selon le modèle (TiAlN, TiCN ou revêtement diamanté).



**Feinstkorn-Hartmetall-Kornstruktur**

**Ultra-Micro-Grain, Korngrößen 0–0,5 µm**

*Finegrain-hardmetal structure*

*Ultra-micro-grain, grain size 0–0.5 micron*

Structure granulaire en carbure micrograins

Ultra-Micro-Grain, tailles des grains 0 – 0,5 µm

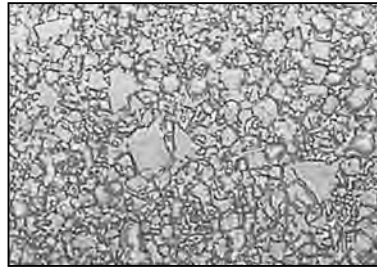

**Allgemeine Hartmetall-Kornstruktur**

*General carbide structure*

Structure granulaire en carbure générale

## Pulvermetallurgische HSS-Fräser... die neue Pulverstahl-Generation! Extrem zäh und verschleißfest.

*Powder metal HSS milling... the new powder steel generation! Very tough and wear resistant.*

Fraises HSS formées par métallurgie des poudres... la nouvelle génération de poudre d'acier! Extrêmement dure et résistante à l'usure.

**Ein Premium-HSS-Stahl der alle bisherigen Leistungsmerkmale in den Schatten stellt. Es ist gelungen, den Anteil eingeschlossener oxydischer Gaskomponenten und Schlackepartikel im Stahl auf ein Minimum zu reduzieren. Dieser besonders homogene Pulverstahl garantiert beste Zerspanungsergebnisse.**

*This PM-HSS-steel overshadows the performance of all previous results. We have succeeded to reduce the oxide components and particles in the steel to an absolute minimum. This especially pure powdersteel guarantees the best cutting performance.*

Un acier HSS premium qui fait de l'ombre à toutes les caractéristiques de performance précédentes. Nous avons réussi à réduire au maximum les traces de gaz oxydé et les particules dans le substrat final. Cet acier fritté particulièrement homogène garantit les meilleurs résultats d'usinage.



**Herkömmlicher HSS-Fräser**

- spröde Kornstruktur
- begrenzte Festigkeit

*Original HSS-milling cutter*

- brittle construction
- limited strength

*Fraise HSS traditionnelle*

- structure granulaire friable
- résistance restreinte

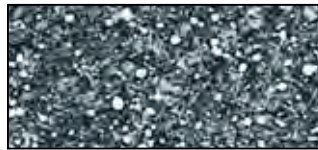

**Pulvermetallurgischer HSS-Fräser**

- feine Mikro-Kornstruktur
- gleichmäßige Kornverteilung
- höchste Festigkeit

*Powder metallurgy HSS-milling cutter*

- fine micro grain structure
- even grain formation
- highest strength

*Fraise HSS formée par métallurgie des poudres*

- microstructure granulaire fine
- répartition uniforme des grains
- résistance élevée

**Im herkömmlich gegossenen Schnellarbeitsstahl sind die Karbidzeilen häufig so groß, dass es auf die Menge eingeschlossener ca. 10 bis 20 µm großer Schlackenpartikel meist nicht ankommt. Die oben abgebildete Darstellungen zeigen deutlich, dass im pulvermetallurgischen Stahl die Karbide wesentlich kleiner (ca. 1 bis 3 µm) sind. Dadurch wird der Einschluss von Schlackepartikeln nur in ganz geringem Maße ermöglicht.**

**Das Resultat: Ein sehr reiner Stahl, der das Risiko des Werkzeugversagens aufgrund metallischer Einschlüsse stark reduziert.**

*In traditional high speed steel the grain size is often so big, that the amount of 10–20 µm larger particles makes no difference. The above pictures shows clearly that in powder steel the grain size is much smaller (approx 1–3 µm). Therefore the contamination by particles is much reduced.*

*The Result: A very clean steel, which strongly reduces the risk of tool breakage due to contamination.*

Dans l'acier rapide coulé de manière classique, la taille du grain est souvent si grande que la quantité des plus grandes particules renfermées d'env. 10 à 20 µm ne fait aucune différence. Les illustrations ci-dessus montrent clairement que dans l'acier formé par métallurgie des poudres, la taille des grains est nettement plus petite (env. 1 à 3 µm). Par conséquent, la contamination par les particules est très réduite.

Le résultat : Un acier très fin qui réduit considérablement le risque d'abîmer les outils dû à des inclusions métalliques.



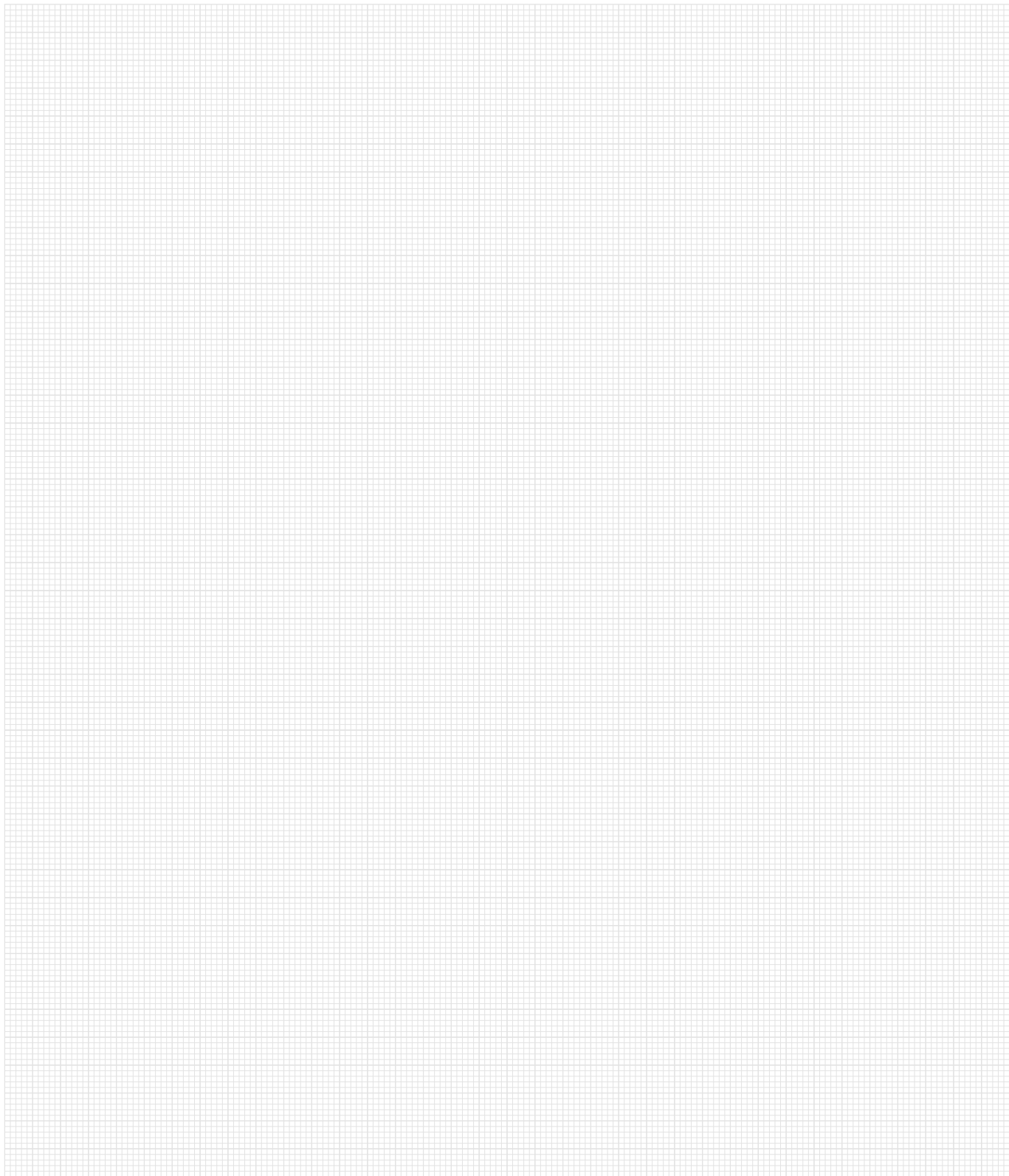

**Weitere Informationen finden Sie unter**  
*For more information see*  
**Pour plus d'informations**

**[www.arno.de](http://www.arno.de)**

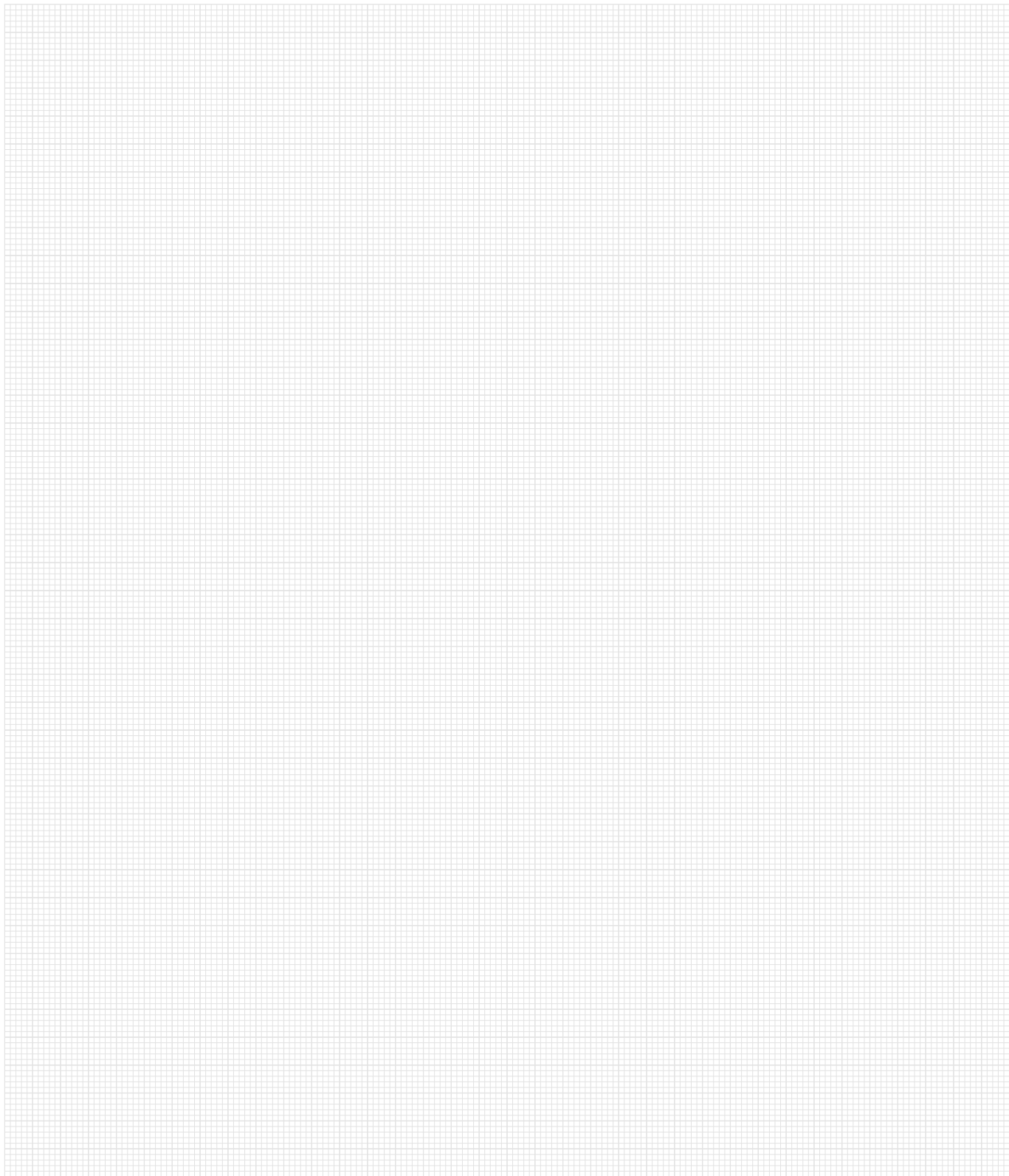

**Weitere Informationen finden Sie unter**  
*For more information see*  
**Pour plus d'informations**

**[www.arno.de](http://www.arno.de)**

# HERAUSRAGEND. OUTSTANDING. REMARQUABLE.

**Kurz- oder Langdrehen, Stechen, Drehen, Bohren oder Fräsen: Was auch immer Sie vorhaben – es lohnt sich, bei ARNO vorbeizuschauen. Wir haben für fast jeden Anwendungsfall in der Zerspanung eine Lösung. Mit der richtigen Mischung aus Erfahrung, Pioniergeist und Qualität sorgen wir dafür, dass Sie mit passgenauen Werkzeugsystemen, Toolmanagement-Lösungen und cleveren Innovationen das Beste aus Ihrer Fertigung rausholen.**

*Turning or Swiss type turning, grooving, drilling or milling: whatever your requirements are, it's worth your while to take a look at ARNO. We have a solution for almost every metal-working application. We have the right mix of experience, pioneering spirit and quality to ensure that you get the best out of your production with the right tool systems, tool management solutions and clever innovations.*

Décolletage, usinage de gorges, tournage, perçage ou fraisage : Quel que soit votre projet, n'hésitez pas à passer chez ARNO, cela en vaut la peine. Nous avons une solution pour quasiment toutes les applications d'enlèvement de copeaux. Avec la bonne combinaison d'expérience, d'esprit pionnier et de qualité, nous veillons à ce que vous tiriez le meilleur de votre fabrication à l'aide de systèmes d'outils, de solutions de gestion des outils et d'innovations intelligentes sur mesure.



---

**Fordern Sie unsere weiteren Broschüren oder den Gesamtkatalog an.**

*For further information please ask for our complete catalogue.*

*Demandez nos autres brochures ou le catalogue complet.*

**Werkzeugsysteme zum Ein- und Abstechen, Drehen und Gewindedrehen,  
Fräsen und Gewindefräsen, Bohren und zum Langdrehen.**

*Tool systems for parting and grooving, turning and threading,  
milling and thread milling, drilling and for swiss type machining.*

*Systèmes d'outillage pour le tronçonnage et les gorges, pour le tournage et filetage,  
pour le fraisage et filetage, pour le perçage et pour le décolletage.*

**Karl-Heinz Arnold GmbH**  
Karlsbader Str. 4 | D-73760 Ostfildern  
Tel.: +49 (0)711 34 802 0  
Fax: +49 (0)711 34 802 130

bestellung@arno.de  
anfrage@arno.de  
www.arno.de

**ARNO (UK) Limited** | Unit 9, 10 & 11, Sugnall Business Centre  
Sugnall, Eccleshall | Staffordshire | ST21 6NF  
Tel.: +44 01785 850 072 | Fax: +44 01785 850 076  
sales@arno.de | www.arno-tools.co.uk

**ARNO Italia S.r.l** | Via J. F. Kennedy 19 | 20871 Vimercate (MB)  
Tel.: +39 039 68 52 101 | Fax: +39 039 60 83 724  
info@arno-italia.it | www.arno-italia.it

**ARNO-Werkzeuge USA LLC** | 1101 W. Diggins St.  
US-60033 Harvard, Illinois  
Tel.: +1 815 943 4426 | Fax: +1 815 943 7156  
info@arnousa.com | www.arnousa.com

**ARNO RU Ltd.** | Krassnaja Ul. 38 | RU-600015 Vladimir  
Tel.: / Fax: +7 4922 541125 | COT +7 4922 541135  
info@arnoru.ru | www.arnoru.ru

**ARNO Werkzeuge S.E.A. PTE. LTD.** | 25 International Business  
Park | #04 – 70A German Center | SG-609916 Singapore  
Tel.: +65 65130779 | Fax: +65 68970042  
info@arno.com.sg | www.arno.com.sg

**AIF Cluses** | 310 Rue des îles | 74300 CLUSES  
Tél.: 00 33 (0)4 50 18 24 07 | Fax: 00 33 (0)4 50 89 04 81  
cluses@aif.fr

**AIF - Ateliers de l'Île-de-France** | 6 rue des Entrepreneurs  
CS30572 | 77272 VILLEPARISIS Cedex  
Tél.: 00 33 (0)1 64 27 03 30 | Fax : 00 33 (0)1 64 27 03 49  
info@aif.fr | www.aif.fr

**AIF Sud** | ZA des Massies | 2, Impasse du Bosquet  
81800 Couffouleux  
Tél : 00 33 (0)5 63 33 60 42 | sud@aif.fr